

UTC2SA1020

PNP EPITAXIAL SILICON TRANSISTOR

SILICON PNP EPITAXIAL TRANSISTOR

DESCRIPTION

The UTC 2SA1020 is designed for power amplifier and power switching applications.

FEATURES

- *Low collector saturation voltage:
VCE(sat)=-0.5V(max.) (IC=-1A)
- *High speed switching time: tstg=1.0μs(Typ.)
- *Complement to UTC 2SC2655

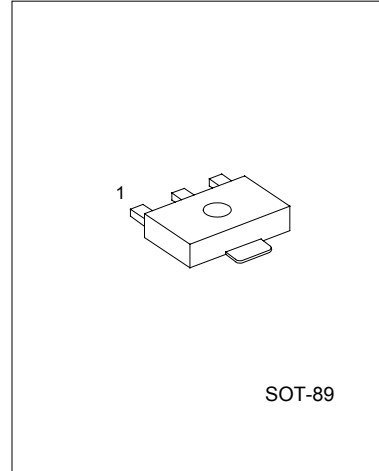

SOT-89

1:EMITTER 2:COLLECTOR 3:BASE

ABSOLUTE MAXIMUM RATINGS (Ta=25°C)

PARAMETER	SYMBOL	VALUE	UNIT
Collector-Base Voltage	V _{CB0}	-50	V
Collector-Emitter Voltage	V _{CEO}	-50	V
Emitter-Base Voltage	V _{EB0}	-5	V
Collector Current	I _c	-2	A
Collector Power Dissipation	P _c	0.5	W
Collector Power Dissipation	P _c *	1	W
Junction Temperature	T _j	150	°C
Storage Temperature	T _{STG}	-55 ~ +150	°C

* : Mounted on ceramic substrate(250mm² × 0.8t)

ELECTRICAL CHARACTERISTICS (Ta=25°C, unless otherwise specified)

PARAMETER	SYMBOL	TEST CONDITIONS	MIN	TYP	MAX	UNIT	
Collector cut-off current	I _{CB0}	V _{CB} =-50V, I _E =0			-1.0	μA	
Emitter cut-off current	I _{EB0}	V _{EB} =-5V, I _C =0			-1.0	μA	
Collector to emitter breakdown voltage	V _{(BR)CEO}	I _c =-10mA, I _B =0	-50			V	
DC Current Gain	h _{FE1}	V _{CE} =-2V, I _C =-0.5A	70		240		
	h _{FE2}	V _{CE} =-2V, I _C =-1.5A	40				
Collector to emitter saturation voltage	V _{CE(sat)}	I _c =-1A, I _B =-0.05A			-0.5	V	
Base to emitter saturation voltage	V _{BE(sat)}	I _c =-1A, I _B =-0.05A			-1.2	V	
Transition frequency	f _T	V _{CE} =-2V, I _C =-0.5A		100		MHz	
Collector output capacitance	C _{ob}	V _{CB} =-10V, I _E =0, f=1MHz		40		pF	
Switching time	Turn-on time			0.1		μs	
	Storage time		tstg		1.0		μs
	Fall time		tf		0.1		μs

UTC UNISONIC TECHNOLOGIES CO. LTD

1

QW-R208-021,A

UTC2SA1020 PNP EPITAXIAL SILICON TRANSISTOR

CLASSIFICATION OF h_{FE1}

RANK	O	Y
RANGE	70 - 140	120 - 240

TYPICAL PERFORMANCE CHARACTERISTICS

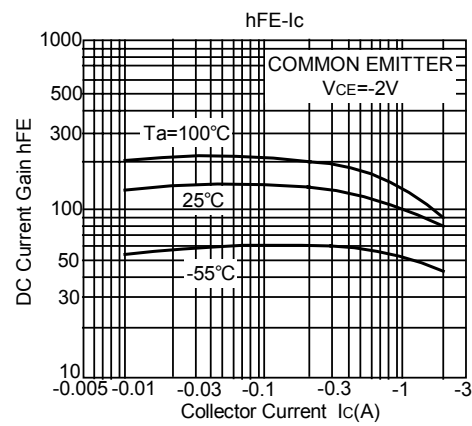
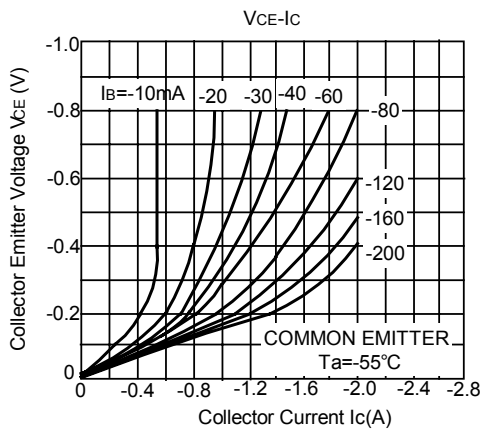
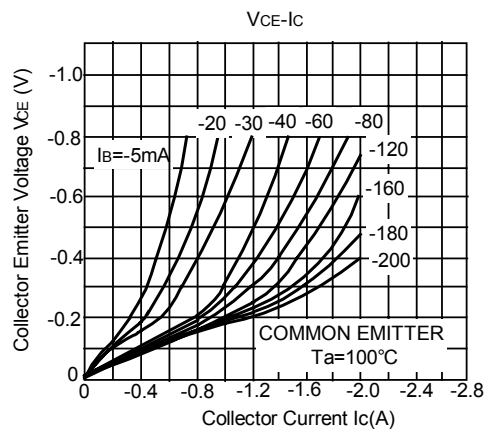
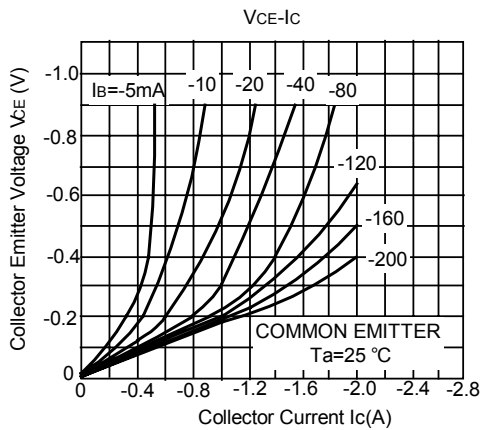

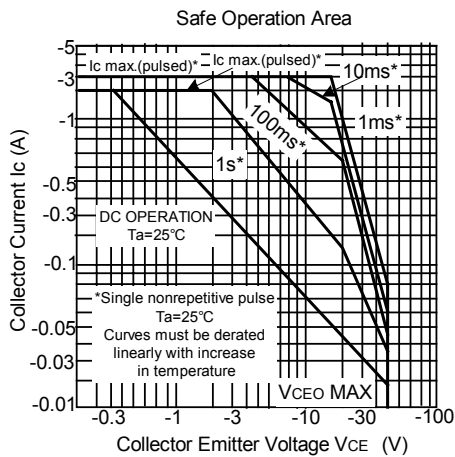
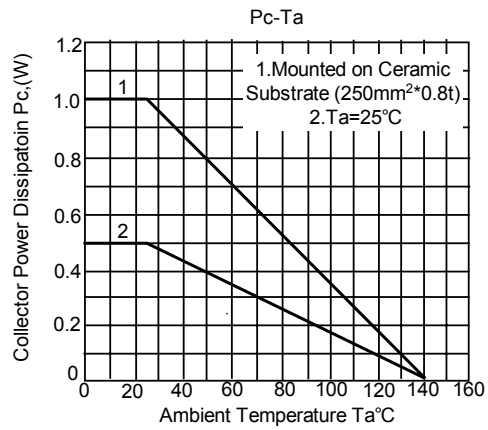
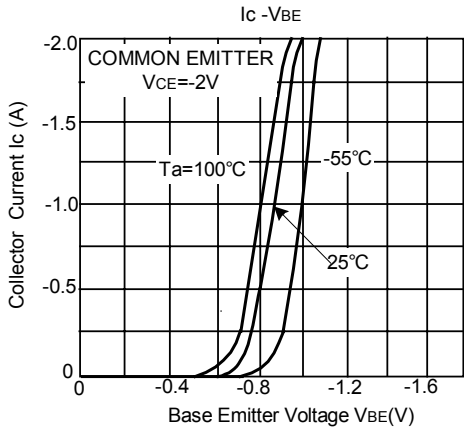
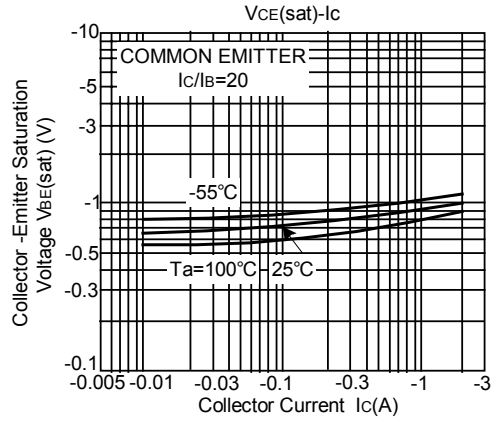
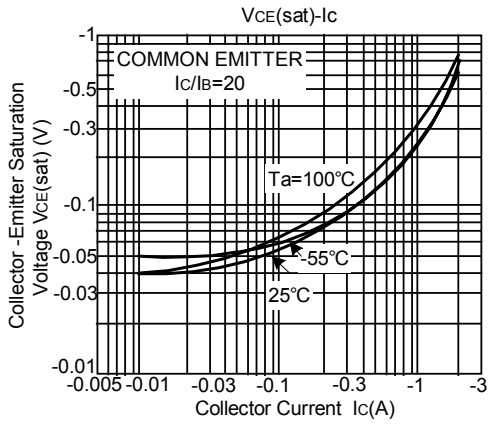

UTC2SA1020 PNP EPITAXIAL SILICON TRANSISTOR

UTC assumes no responsibility for equipment failures that result from using products at values that exceed, even momentarily, rated values (such as maximum ratings, operating condition ranges, or other parameters) listed in products specifications of any and all UTC products described or contained herein. UTC products are not designed for use in life support appliances, devices or systems where malfunction of these products can be reasonably expected to result in personal injury. Reproduction in whole or in part is prohibited without the prior written consent of the copyright owner. The information presented in this document does not form part of any quotation or contract, is believed to be accurate and reliable and may be changed without notice.