

# UTC2SB772S

# PNP EPITAXIAL SILICON TRANSISTOR

## MEDIUM POWER LOW VOLTAGE TRANSISTOR

### DESCRIPTION

The UTC 2SB772S is a medium power low voltage transistor, designed for audio power amplifier, DC-DC converter and voltage regulator.

### FEATURES

- \*High current output up to 3A
- \*Low saturation voltage
- \*Complement to 2SD882S

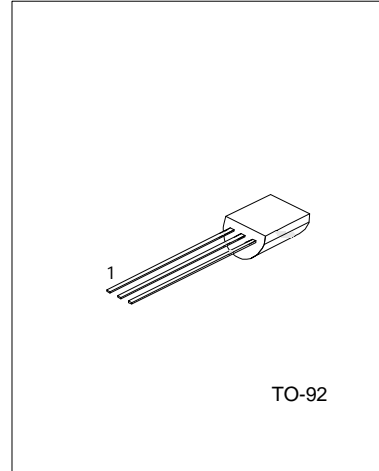

1:EMITTER 2:COLLECTOR 3:BASE

### ABSOLUTE MAXIMUM RATINGS ( Ta=25°C ,unless otherwise specified )

PARAMETER	SYMBOL	VALUE	UNIT
Collector-Base Voltage	VCBO	-40	V
Collector-Emitter Voltage	VCEO	-30	V
Emitter-Base Voltage	VEBO	-5	V
Collector Dissipation( Tc=25°C)	Pc	10	W
Collector Dissipation( Ta=25°C)	Pc	1	W
Collector Current(DC)	Ic	-3	A
Collector Current(PULSE)	Ic	-7	A
Base Current	IB	-0.6	A
Junction Temperature	Tj	150	°C
Storage Temperature	TSTG	-55 ~ +150	°C

### ELECTRICAL CHARACTERISTICS(Ta=25°C,unless otherwise specified)

PARAMETER	SYMBOL	TEST CONDITIONS	MIN	TYP	MAX	UNIT
Collector Cut-Off Current	ICBO	VCB=-30V,IE=0			-1000	nA
Emitter Cut-Off Current	IEBO	VEB=-3V,Ic=0			-1000	nA
DC Current Gain(note 1)	hFE1	VCE=-2V,Ic=-20mA	30	200		
	hFE2	VCE=-2V,Ic=-1A	100	150	400	
Collector-Emitter Saturation Voltage	VCE(sat)	Ic=-2A,IB=-0.2A		-0.3	-0.5	V
Base-Emitter Saturation Voltage	VBE(sat)	Ic=-2A,IB=-0.2A		-1.0	-2.0	V
Current Gain Bandwidth Product	fT	VCE=-5V,Ic=-0.1A		80		MHz
Output Capacitance	Cob	VCB=-10V,IE=0,f=1MHz		45		pF

Note 1:Pulse test:PW<300µs,Duty Cycle<2%

### CLASSIFICATION OF hFE

RANK	Q	P	E
RANGE	100-200	160-320	200-400

TYPICAL PERFORMANCE CHARACTERISTICS

Fig.1 Static characteristics

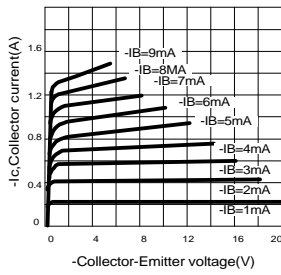

Fig.2 Derating curve of safe operating areas

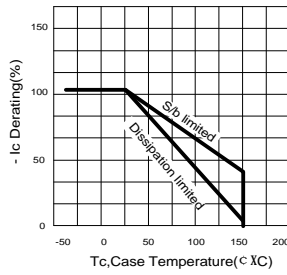

Fig.3 Power Derating

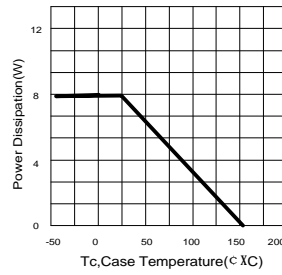

Fig.4 Collector output capacitance

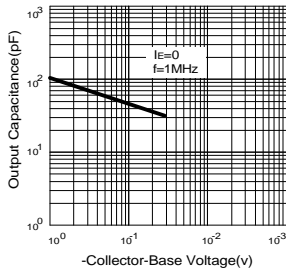

Fig.5 Current gain-bandwidth product

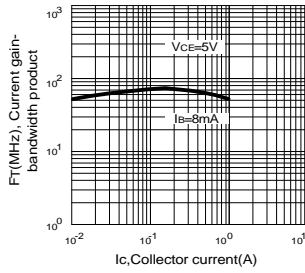

Fig.6 Safe operating area

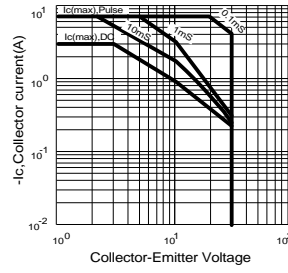

Fig.7 DC current gain

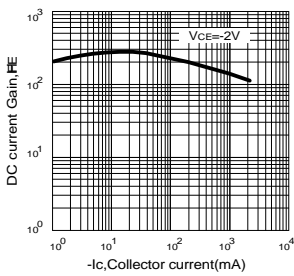

Fig.8 Saturation Voltage

