

# UTC2SD882

# NPN EPITAXIAL SILICON TRANSISTOR

## MEDIUM POWER LOW VOLTAGE TRANSISTOR

### FEATURES

- \*High current output up to 3A
- \*Low saturation voltage
- \*Complement to 2SB772

### APPLICATIONS

- \* Audio power amplifier
- \* DC-DC convertor
- \* Voltage regulator

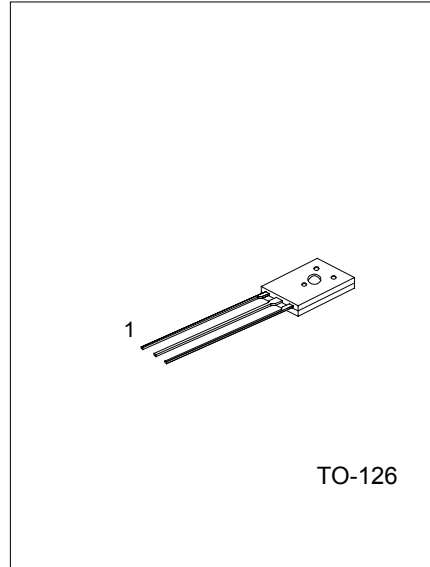

1:EMITTER 2:COLLECTOR 3:BASE

### ABSOLUTE MAXIMUM RATINGS ( Ta=25°C ,unless otherwise specified )

PARAMETER	SYMBOL	RATING	UNIT
Collector-base voltage	V <sub>CB0</sub>	40	V
Collector-emitter voltage	V <sub>CEO</sub>	30	V
Emitter-base voltage	V <sub>EB0</sub>	5	V
Collector dissipation( T <sub>c</sub> =25°C)	P <sub>c</sub>	10	W
Collector dissipation( Ta=25°C)	P <sub>c</sub>	1	W
Collector current(DC)	I <sub>c</sub>	3	A
Collector current(PULSE)	I <sub>c</sub>	7	A
Base current	I <sub>B</sub>	0.6	A
Junction Temperature	T <sub>j</sub>	150	°C
Storage Temperature	T <sub>STG</sub>	-55 ~ +150	°C

### ELECTRICAL CHARACTERISTICS(Ta=25°C,unless otherwise specified)

PARAMETER	SYMBOL	TEST CONDITIONS	MIN	TYP	MAX	UNIT
Collector cut-off current	I <sub>CB0</sub>	V <sub>CB</sub> =30V,I <sub>E</sub> =0			1000	nA
Emitter cut-off current	I <sub>EB0</sub>	V <sub>EB</sub> =3V,I <sub>c</sub> =0			1000	nA
DC current gain(note 1)	h <sub>FE1</sub>	V <sub>CE</sub> =2V,I <sub>c</sub> =20mA	30	200		
	h <sub>FE2</sub>	V <sub>CE</sub> =2V,I <sub>c</sub> =1A	100	150	400	
Collector-emitter saturation voltage	V <sub>CE(sat)</sub>	I <sub>c</sub> =2A,I <sub>B</sub> =0.2A		0.3	0.5	V
Base-emitter saturation voltage	V <sub>BE(sat)</sub>	I <sub>c</sub> =2A,I <sub>B</sub> =0.2A		1.0	2.0	V
Current gain bandwidth product	f <sub>T</sub>	V <sub>CE</sub> =5V,I <sub>c</sub> =0.1A		80		MHz
Output capacitance	C <sub>ob</sub>	V <sub>CB</sub> =10V,I <sub>E</sub> =0,f=1MHz		45		pF

Note 1:Pulse test:PW<300μs,Duty Cycle<2%

# UTC2SD882 NPN EPITAXIAL SILICON TRANSISTOR

## CLASSIFICATION OF hFE2

RANK	Q	P	E
RANGE	100-200	160-320	200-400

## TYPICAL PARAMETERS PERFORMANCE

Fig.1 Static characteristics

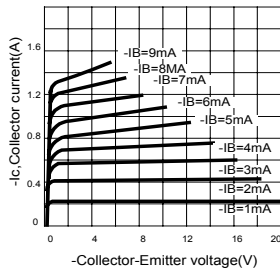

Fig.2 Derating curve of safe operating areas

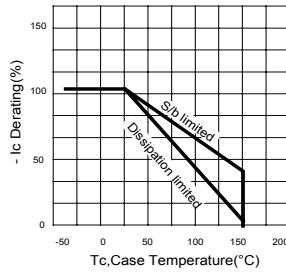

Fig.3 Power Derating

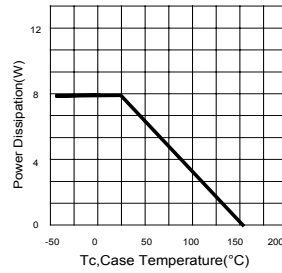

Fig.4 Collector Output capacitance

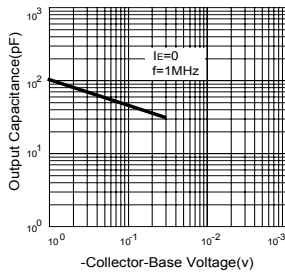

Fig.5 Current gain-bandwidth product

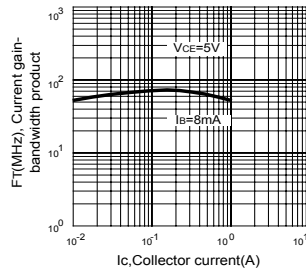

Fig.6 Safe operating area

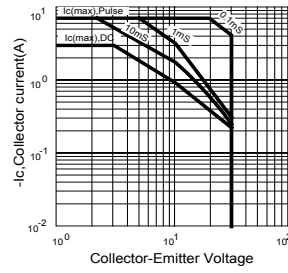

Fig.7 DC current gain

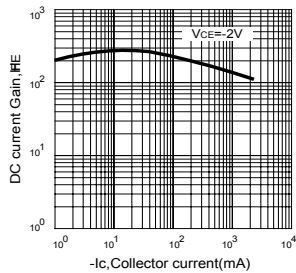

Fig.8 Saturation Voltage

