

1SMB5.0AT3 Series

600 Watt Peak Power Zener Transient Voltage Suppressors

Unidirectional*

The SMB series is designed to protect voltage sensitive components from high voltage, high energy transients. They have excellent clamping capability, high surge capability, low zener impedance and fast response time. The SMB series is supplied in ON Semiconductor's exclusive, cost-effective, highly reliable Surmetic™ package and is ideally suited for use in communication systems, automotive, numerical controls, process controls, medical equipment, business machines, power supplies and many other industrial/consumer applications.

Specification Features

- Working Peak Reverse Voltage Range – 5.0 V to 170 V
- Standard Zener Breakdown Voltage Range – 6.7 V to 199 V
- Peak Power – 600 W @ 1.0 ms
- ESD Rating of Class 3 (>16 kV) per Human Body Model
- Maximum Clamp Voltage @ Peak Pulse Current
- Low Leakage < 5.0 μ A Above 10 V
- UL 497B for Isolated Loop Circuit Protection
- Response Time is Typically < 1.0 ns
- Pb-Free Packages are Available

Mechanical Characteristics

CASE: Void-free, transfer-molded, thermosetting plastic

FINISH: All external surfaces are corrosion resistant and leads are readily solderable

MAXIMUM CASE TEMPERATURE FOR SOLDERING PURPOSES:
260°C for 10 Seconds

LEADS: Modified L-Bend providing more contact area to bond pads

POLARITY: Cathode indicated by polarity band

MOUNTING POSITION: Any

*Please see 1SMB10CAT3 to 1SMB78CAT3 for Bidirectional devices.



ON Semiconductor®

<http://onsemi.com>

**PLASTIC SURFACE MOUNT
ZENER OVERVOLTAGE
TRANSIENT SUPPRESSORS
5.0 V – 170 V,
600 W PEAK POWER**

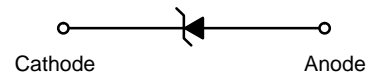

**SMB
CASE 403A
PLASTIC**

MARKING DIAGRAM

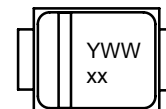

Y = Year
WW = Work Week
xx = Specific Device Code
(See Table Page 3)

ORDERING INFORMATION

Device	Package	Shipping†
1SMBxxxAT3	SMB	2500/Tape & Reel
1SMBxxxAT3G	SMB (Pb-Free)	2500/Tape & Reel

†For information on tape and reel specifications, including part orientation and tape sizes, please refer to our Tape and Reel Packaging Specifications Brochure, BRD8011/D.

Individual devices are listed on page 3 of this data sheet.

1SMB5.0AT3 Series

MAXIMUM RATINGS

Rating	Symbol	Value	Unit
Peak Power Dissipation (Note 1) @ $T_L = 25^\circ\text{C}$, Pulse Width = 1 ms	P_{PK}	600	W
DC Power Dissipation @ $T_L = 75^\circ\text{C}$ Measured Zero Lead Length (Note 2) Derate Above 75°C	P_D	3.0	W
Thermal Resistance from Junction-to-Lead	$R_{\theta JL}$	40	$\text{mW}/^\circ\text{C}$
Thermal Resistance from Junction-to-Ambient	$R_{\theta JA}$	226	$^\circ\text{C}/\text{W}$
DC Power Dissipation (Note 3) @ $T_A = 25^\circ\text{C}$ Derate Above 25°C	P_D	0.55	W
Thermal Resistance from Junction-to-Ambient	$R_{\theta JA}$	4.4	$\text{mW}/^\circ\text{C}$
Forward Surge Current (Note 4) @ $T_A = 25^\circ\text{C}$	I_{FSM}	100	A
Operating and Storage Temperature Range	T_J, T_{stg}	-65 to +150	$^\circ\text{C}$

Maximum ratings are those values beyond which device damage can occur. Maximum ratings applied to the device are individual stress limit values (not normal operating conditions) and are not valid simultaneously. If these limits are exceeded, device functional operation is not implied, damage may occur and reliability may be affected.

- 10 X 1000 μs , non-repetitive
- 1" square copper pad, FR-4 board
- FR-4 board, using ON Semiconductor minimum recommended footprint, as shown in 403A case outline dimensions spec.
- 1/2 sine wave (or equivalent square wave), PW = 8.3 ms, duty cycle = 4 pulses per minute maximum.

ELECTRICAL CHARACTERISTICS ($T_A = 25^\circ\text{C}$ unless otherwise noted, $V_F = 3.5\text{ V Max.}$ @ I_F (Note 5) = 30 A)

Symbol	Parameter
I_{PP}	Maximum Reverse Peak Pulse Current
V_C	Clamping Voltage @ I_{PP}
V_{RWM}	Working Peak Reverse Voltage
I_R	Maximum Reverse Leakage Current @ V_{RWM}
V_{BR}	Breakdown Voltage @ I_T
I_T	Test Current
I_F	Forward Current
V_F	Forward Voltage @ I_F

- 1/2 sine wave (or equivalent square wave), PW = 8.3 ms, non-repetitive duty cycle.

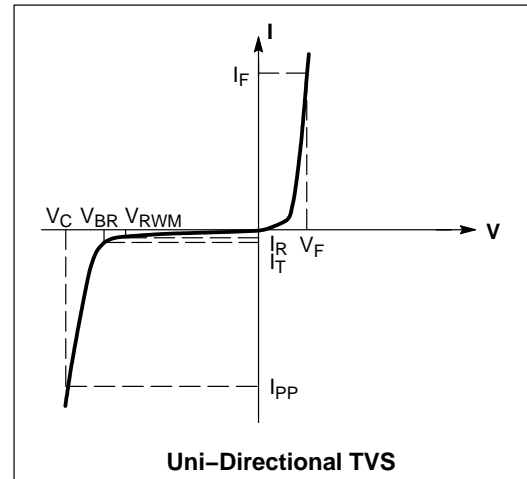

1SMB5.0AT3 Series

ELECTRICAL CHARACTERISTICS (Devices listed in *bold, italic* are ON Semiconductor Preferred devices.)

Device	Device Marking	V _{RWM} (Note 6) Volts	I _R @ V _{RWM} μA	Breakdown Voltage				V _C @ I _{PP} (Note 8)	
				V _{BR} (Note 7) Volts			@ I _T	V _C	I _{PP}
				Min	Nom	Max	mA	Volts	Amps
1SMB5.0AT3	KE	5.0	800	6.40	6.7	7.0	10	9.2	65.2
1SMB6.0AT3, G*	KG	6.0	800	6.67	7.02	7.37	10	10.3	58.3
1SMB6.5AT3	KK	6.5	500	7.22	7.6	7.98	10	11.2	53.6
1SMB7.0AT3	KM	7.0	500	7.78	8.19	8.6	10	12.0	50.0
1SMB7.5AT3	KP	7.5	100	8.33	8.77	9.21	1.0	12.9	46.5
1SMB8.0AT3	KR	8.0	50	8.89	9.36	9.83	1.0	13.6	44.1
1SMB8.5AT3	KT	8.5	10	9.44	9.92	10.4	1.0	14.4	41.7
1SMB9.0AT3	KV	9.0	5.0	10.0	10.55	11.1	1.0	15.4	39.0
1SMB10AT3	KX	10	5.0	11.1	11.7	12.3	1.0	17.0	35.3
1SMB11AT3	KZ	11	5.0	12.2	12.85	13.5	1.0	18.2	33.0
1SMB12AT3	LE	12	5.0	13.3	14	14.7	1.0	19.9	30.2
1SMB13AT3	LG	13	5.0	14.4	15.15	15.9	1.0	21.5	27.9
1SMB14AT3	LK	14	5.0	15.6	16.4	17.2	1.0	23.2	25.8
1SMB15AT3, G*	LM	15	5.0	16.7	17.6	18.5	1.0	24.4	24.0
1SMB16AT3	LP	16	5.0	17.8	18.75	19.7	1.0	26.0	23.1
1SMB17AT3	LR	17	5.0	18.9	19.9	20.9	1.0	27.6	21.7
1SMB18AT3	LT	18	5.0	20.0	21.05	22.1	1.0	29.2	20.5
1SMB20AT3	LV	20	5.0	22.2	23.35	24.5	1.0	32.4	18.5
1SMB22AT3	LX	22	5.0	24.4	25.65	26.9	1.0	35.5	16.9
1SMB24AT3, G*	LZ	24	5.0	26.7	28.1	29.5	1.0	38.9	15.4
1SMB26AT3	ME	26	5.0	28.9	30.4	31.9	1.0	42.1	14.2
1SMB28AT3, G*	MG	28	5.0	31.1	32.75	34.4	1.0	45.4	13.2
1SMB30AT3, G*	MK	30	5.0	33.3	35.05	36.8	1.0	48.4	12.4
1SMB33AT3, G*	MM	33	5.0	36.7	38.65	40.6	1.0	53.3	11.3
1SMB36AT3	MP	36	5.0	40.0	42.1	44.2	1.0	58.1	10.3
1SMB40AT3	MR	40	5.0	44.4	46.75	49.1	1.0	64.5	9.3
1SMB43AT3	MT	43	5.0	47.8	50.3	52.8	1.0	69.4	8.6
1SMB45AT3	MV	45	5.0	50.0	52.65	55.3	1.0	72.7	8.3
1SMB48AT3	MX	48	5.0	53.3	56.1	58.9	1.0	77.4	7.7
1SMB51AT3	MZ	51	5.0	56.7	59.7	62.7	1.0	82.4	7.3
1SMB54AT3	NE	54	5.0	60.0	63.15	66.3	1.0	87.1	6.9
1SMB58AT3	NG	58	5.0	64.4	67.8	71.2	1.0	93.6	6.4
1SMB60AT3	NK	60	5.0	66.7	70.2	73.7	1.0	96.8	6.2
1SMB64AT3	NM	64	5.0	71.1	74.85	78.6	1.0	103	5.8
1SMB70AT3	NP	70	5.0	77.8	81.9	86	1.0	113	5.3
1SMB75AT3	NR	75	5.0	83.3	87.7	92.1	1.0	121	4.9
1SMB85AT3	NV	85	55.0	94.4	99.2	104	1.0	137	4.4
1SMB90AT3	NX	90	5.0	100	105.5	111	1.0	146	4.1
1SMB100AT3	NZ	100	5.0	111	117	123	1.0	162	3.7
1SMB110AT3	PE	110	5.0	122	128.5	135	1.0	177	3.4
1SMB120AT3	PG	120	5.0	133	140	147	1.0	193	3.1
1SMB130AT3	PK	130	5.0	144	151.5	159	1.0	209	2.9
1SMB150AT3	PM	150	5.0	167	176	185	1.0	243	2.5
1SMB160AT3	PP	160	5.0	178	187.5	197	1.0	259	2.3
1SMB170AT3	PR	170	5.0	189	199	209	1.0	275	2.2

6. A transient suppressor is normally selected according to the working peak reverse voltage (V_{RWM}), which should be equal to or greater than the DC or continuous peak operating voltage level.

7. V_{BR} measured at pulse test current I_T at an ambient temperature of 25°C.

8. Surge current waveform per Figure 2 and derate per Figure 4 of the General Data – 600 W at the beginning of this group.

* The “G” suffix indicates Pb-Free package available.

1SMB5.0AT3 Series

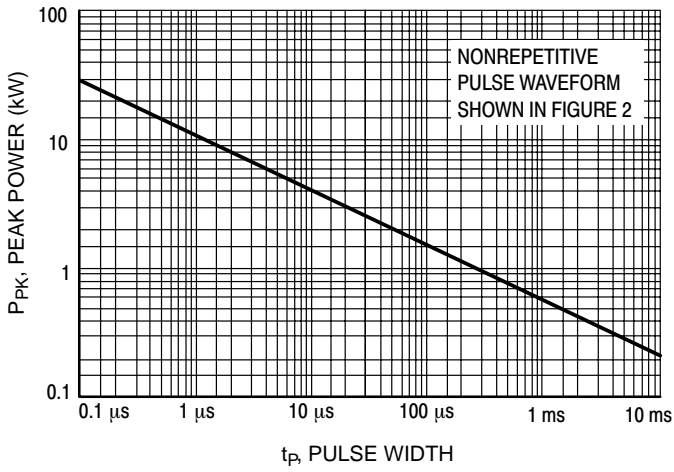

Figure 1. Pulse Rating Curve

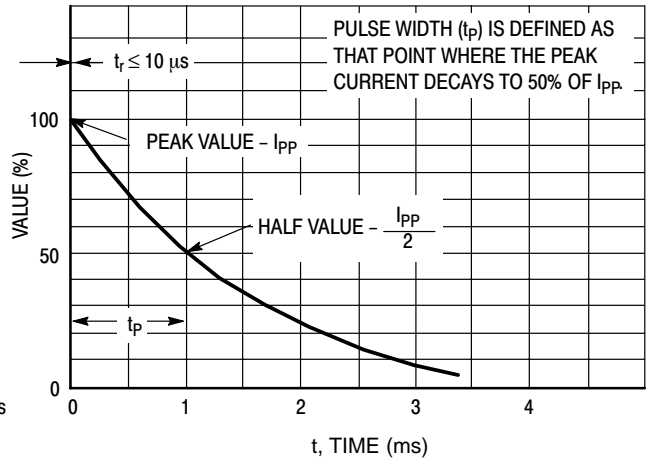

Figure 2. Pulse Waveform

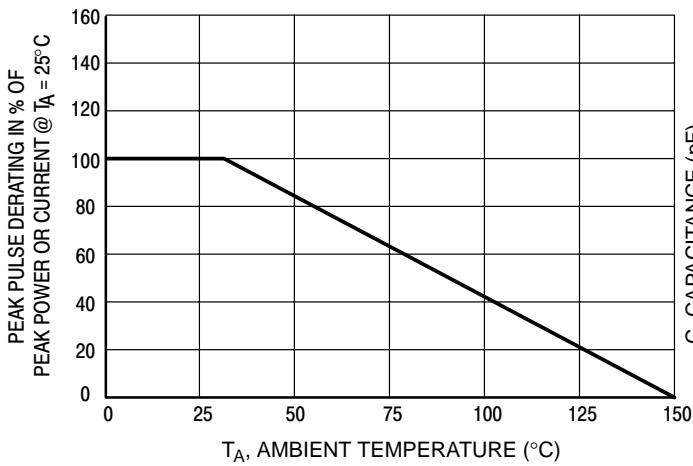

Figure 4. Pulse Derating Curve

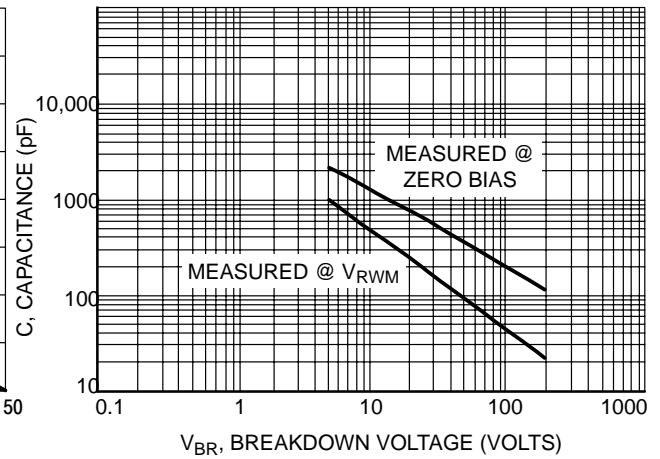

Figure 5. Capacitance versus Breakdown Voltage

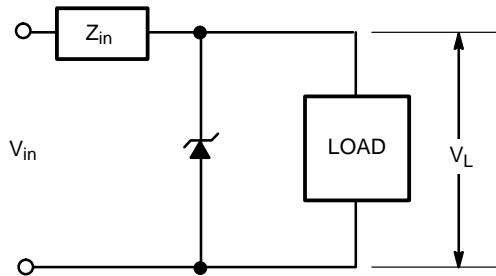

Figure 3. Typical Protection Circuit

1SMB5.0AT3 Series

APPLICATION NOTES

RESPONSE TIME

In most applications, the transient suppressor device is placed in parallel with the equipment or component to be protected. In this situation, there is a time delay associated with the capacitance of the device and an overshoot condition associated with the inductance of the device and the inductance of the connection method. The capacitive effect is of minor importance in the parallel protection scheme because it only produces a time delay in the transition from the operating voltage to the clamp voltage as shown in Figure 6.

The inductive effects in the device are due to actual turn-on time (time required for the device to go from zero current to full current) and lead inductance. This inductive effect produces an overshoot in the voltage across the equipment or component being protected as shown in Figure 7. Minimizing this overshoot is very important in the application, since the main purpose for adding a transient suppressor is to clamp voltage spikes. The SMB series have a very good response time, typically < 1.0 ns and negligible inductance. However, external inductive effects could produce unacceptable overshoot. Proper circuit layout,

minimum lead lengths and placing the suppressor device as close as possible to the equipment or components to be protected will minimize this overshoot.

Some input impedance represented by Z_{in} is essential to prevent overstress of the protection device. This impedance should be as high as possible, without restricting the circuit operation.

DUTY CYCLE DERATING

The data of Figure 1 applies for non-repetitive conditions and at a lead temperature of 25°C. If the duty cycle increases, the peak power must be reduced as indicated by the curves of Figure 8. Average power must be derated as the lead or ambient temperature rises above 25°C. The average power derating curve normally given on data sheets may be normalized and used for this purpose.

At first glance the derating curves of Figure 8 appear to be in error as the 10 ms pulse has a higher derating factor than the 10 μ s pulse. However, when the derating factor for a given pulse of Figure 8 is multiplied by the peak power value of Figure 1 for the same pulse, the results follow the expected trend.

1SMB5.0AT3 Series

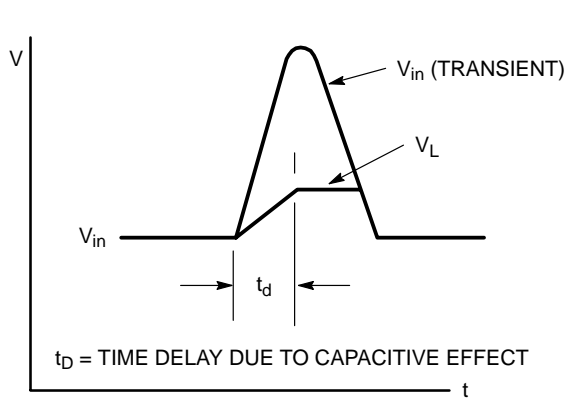

Figure 6.

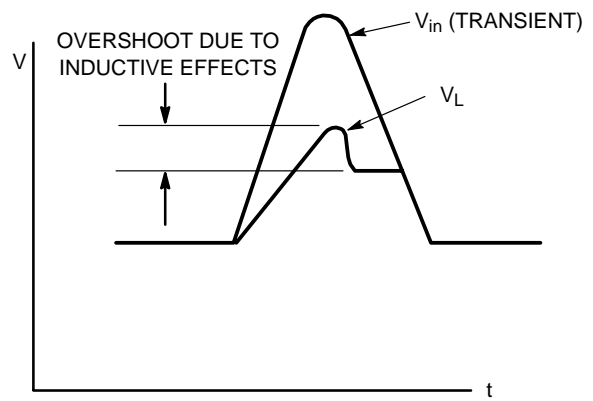

Figure 7.

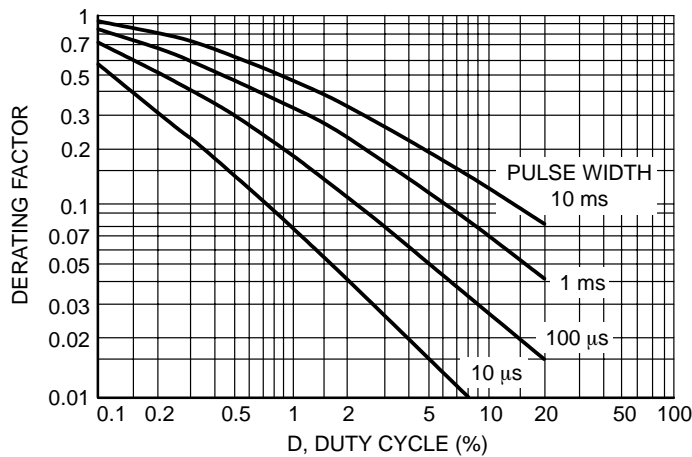

Figure 8. Typical Derating Factor for Duty Cycle

UL RECOGNITION

The entire series has *Underwriters Laboratory Recognition* for the classification of protectors (QVGV2) under the UL standard for safety 497B and File #116110. Many competitors only have one or two devices recognized or have recognition in a non-protective category. Some competitors have no recognition at all. With the UL497B recognition, our parts successfully passed several tests

including Strike Voltage Breakdown test, Endurance Conditioning, Temperature test, Dielectric Voltage-Withstand test, Discharge test and several more.

Whereas, some competitors have only passed a flammability test for the package material, we have been recognized for much more to be included in their Protector category.

1SMB5.0AT3 Series

OUTLINE DIMENSIONS

SMB
CASE 403A-03
ISSUE D

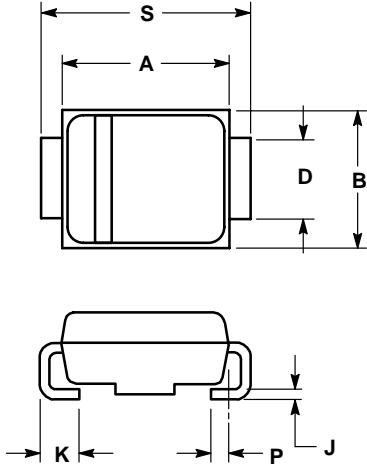

- NOTES:
1. DIMENSIONING AND TOLERANCING PER ANSI Y14.5M, 1982.
 2. CONTROLLING DIMENSION: INCH.
 3. D DIMENSION SHALL BE MEASURED WITHIN DIMENSION P.

DIM	INCHES		MILLIMETERS	
	MIN	MAX	MIN	MAX
A	0.160	0.180	4.06	4.57
B	0.130	0.150	3.30	3.81
C	0.075	0.095	1.90	2.41
D	0.077	0.083	1.96	2.11
H	0.0020	0.0060	0.051	0.152
J	0.006	0.012	0.15	0.30
K	0.030	0.050	0.76	1.27
P	0.020 REF		0.51 REF	
S	0.205	0.220	5.21	5.59

SOLDERING FOOTPRINT*

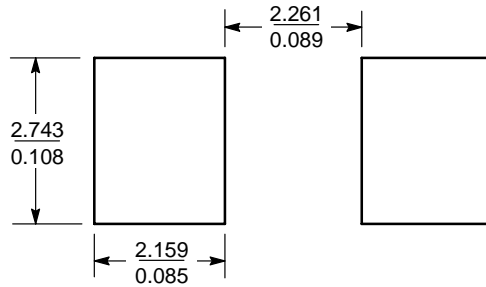

SCALE 8:1 $\left(\frac{\text{mm}}{\text{inches}}\right)$

*For additional information on our Pb-Free strategy and soldering details, please download the ON Semiconductor Soldering and Mounting Techniques Reference Manual, SOLDERRM/D.

1SMB5.0AT3 Series

SURMETIC is a trademark of Semiconductor Components Industries, LLC.

ON Semiconductor and  are registered trademarks of Semiconductor Components Industries, LLC (SCILLC). SCILLC reserves the right to make changes without further notice to any products herein. SCILLC makes no warranty, representation or guarantee regarding the suitability of its products for any particular purpose, nor does SCILLC assume any liability arising out of the application or use of any product or circuit, and specifically disclaims any and all liability, including without limitation special, consequential or incidental damages. "Typical" parameters which may be provided in SCILLC data sheets and/or specifications can and do vary in different applications and actual performance may vary over time. All operating parameters, including "Typicals" must be validated for each customer application by customer's technical experts. SCILLC does not convey any license under its patent rights nor the rights of others. SCILLC products are not designed, intended, or authorized for use as components in systems intended for surgical implant into the body, or other applications intended to support or sustain life, or for any other application in which the failure of the SCILLC product could create a situation where personal injury or death may occur. Should Buyer purchase or use SCILLC products for any such unintended or unauthorized application, Buyer shall indemnify and hold SCILLC and its officers, employees, subsidiaries, affiliates, and distributors harmless against all claims, costs, damages, and expenses, and reasonable attorney fees arising out of, directly or indirectly, any claim of personal injury or death associated with such unintended or unauthorized use, even if such claim alleges that SCILLC was negligent regarding the design or manufacture of the part. SCILLC is an Equal Opportunity/Affirmative Action Employer. This literature is subject to all applicable copyright laws and is not for resale in any manner.

PUBLICATION ORDERING INFORMATION

LITERATURE FULFILLMENT:

Literature Distribution Center for ON Semiconductor
P.O. Box 5163, Denver, Colorado 80217 USA

Phone: 303-675-2175 or 800-344-3860 Toll Free USA/Canada

Fax: 303-675-2176 or 800-344-3867 Toll Free USA/Canada

Email: orderlit@onsemi.com

N. American Technical Support: 800-282-9855 Toll Free
USA/Canada

Japan: ON Semiconductor, Japan Customer Focus Center
2-9-1 Kamimeguro, Meguro-ku, Tokyo, Japan 153-0051
Phone: 81-3-5773-3850

ON Semiconductor Website: <http://onsemi.com>

Order Literature: <http://www.onsemi.com/litorder>

For additional information, please contact your
local Sales Representative.