

# Complementary Silicon High-Power Transistors

...PowerBase™ complementary transistors designed for high power audio, stepping motor and other linear applications. These devices can also be used in power switching circuits such as relay or solenoid drivers, dc-to-dc converters, inverters, or for inductive loads requiring higher safe operating area than the 2N3055.

- Current-Gain — Bandwidth-Product @  $I_C = 1.0 \text{ Adc}$   
 $f_T = 0.8 \text{ MHz (Min) - NPN}$   
 $= 2.2 \text{ MHz (Min) - PNP}$
- Safe Operating Area — Rated to 60 V and 120 V, Respectively

### \*MAXIMUM RATINGS

Rating	Symbol	2N3055A	MJ15015 MJ15016	Unit
Collector-Emitter Voltage	$V_{CEO}$	60	120	Vdc
Collector-Base Voltage	$V_{CBO}$	100	200	Vdc
Collector-Emitter Voltage Base Reversed Biased	$V_{CEV}$	100	200	Vdc
Emitter-Base Voltage	$V_{EBO}$	7.0		Vdc
Collector Current — Continuous	$I_C$	15		Adc
Base Current	$I_B$	7.0		Adc
Total Device Dissipation @ $T_C = 25^\circ\text{C}$ Derate above $25^\circ\text{C}$	$P_D$	115 0.65	180 1.03	Watts W/ $^\circ\text{C}$
Operating and Storage Junction Temperature Range	$T_J, T_{stg}$	-65 to +200		$^\circ\text{C}$

### THERMAL CHARACTERISTICS

Characteristic	Symbol	Max	Max	Unit
Thermal Resistance, Junction to Case	$R_{\theta JC}$	1.52	0.98	$^\circ\text{C/W}$

\*Indicates JEDEC Registered Data. (2N3055A)

**NPN**  
**2N3055A**

**MJ15015 \***

**PNP**  
**MJ15016 \***

\*ON Semiconductor Preferred Device

**15 AMPERE**  
**COMPLEMENTARY**  
**SILICON**  
**POWER TRANSISTORS**  
**60, 120 VOLTS**  
**115, 180 WATTS**

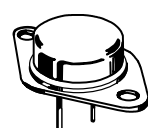

**CASE 1-07**  
**TO-204AA**  
**(TO-3)**

Preferred devices are ON Semiconductor recommended choices for future use and best overall value.

# 2N3055A MJ15015 MJ15016

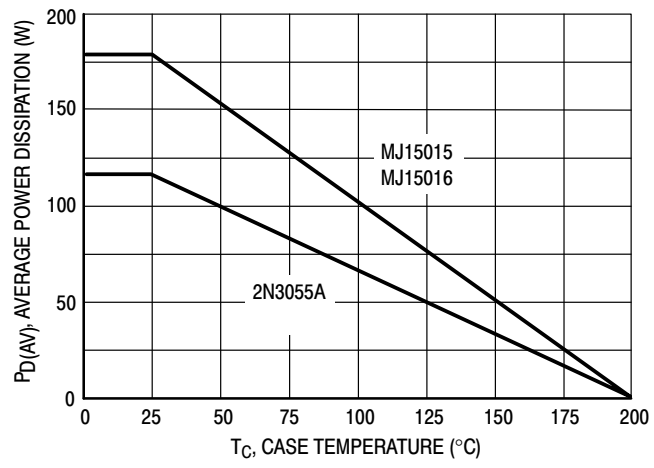

**Figure 1. Power Derating**

## 2N3055A MJ15015 MJ15016

### ELECTRICAL CHARACTERISTICS ( $T_C = 25^\circ\text{C}$ unless otherwise noted)

Characteristic	Symbol	Min	Max	Unit
----------------	--------	-----	-----	------

#### OFF CHARACTERISTICS (1)

*Collector–Emitter Sustaining Voltage ( $I_C = 200\text{ mA}$ , $I_B = 0$ )	2N3055A MJ15015, MJ15016	$V_{CEO(sus)}$	60 120	— —	Vdc
Collector Cutoff Current ( $V_{CE} = 30\text{ Vdc}$ , $V_{BE(off)} = 0\text{ Vdc}$ ) ( $V_{CE} = 60\text{ Vdc}$ , $V_{BE(off)} = 0\text{ Vdc}$ )	2N3055A MJ15015, MJ15016	$I_{CEO}$	— —	0.7 0.1	mA
*Collector Cutoff Current ( $V_{CEV} = \text{Rated Value}$ , $V_{BE(off)} = 1.5\text{ Vdc}$ )	2N3055A MJ15015, MJ15016	$I_{CEV}$	— —	5.0 1.0	mA
Collector Cutoff Current ( $V_{CEV} = \text{Rated Value}$ , $V_{BE(off)} = 1.5\text{ Vdc}$ , $T_C = 150^\circ\text{C}$ )	2N3055A MJ15015, MJ15016	$I_{CEV}$	— —	30 6.0	mA
Emitter Cutoff Current ( $V_{EB} = 7.0\text{ Vdc}$ , $I_C = 0$ )	2N3055A MJ15015, MJ15016	$I_{EBO}$	— —	5.0 0.2	mA

#### \*SECOND BREAKDOWN

Second Breakdown Collector Current with Base Forward Biased ( $t = 0.5\text{ s}$ non-repetitive) ( $V_{CE} = 60\text{ Vdc}$ )	2N3055A MJ15015, MJ15016	$I_{S/b}$	1.95 3.0	— —	A
---	-----------------------------	-----------	-------------	--------	---

#### \*ON CHARACTERISTICS (1)

DC Current Gain ( $I_C = 4.0\text{ A}$ , $V_{CE} = 2.0\text{ Vdc}$ ) ( $I_C = 4.0\text{ A}$ , $V_{CE} = 4.0\text{ Vdc}$ ) ( $I_C = 10\text{ A}$ , $V_{CE} = 4.0\text{ Vdc}$ )	$h_{FE}$	10 20 5.0	70 70 —	—
Collector–Emitter Saturation Voltage ( $I_C = 4.0\text{ A}$ , $I_B = 400\text{ mA}$ ) ( $I_C = 10\text{ A}$ , $I_B = 3.3\text{ A}$ ) ( $I_C = 15\text{ A}$ , $I_B = 7.0\text{ A}$ )	$V_{CE(sat)}$	— — —	1.1 3.0 5.0	Vdc
Base–Emitter On Voltage ( $I_C = 4.0\text{ A}$ , $V_{CE} = 4.0\text{ Vdc}$ )	$V_{BE(on)}$	0.7	1.8	Vdc

#### \*DYNAMIC CHARACTERISTICS

Current–Gain — Bandwidth Product ( $I_C = 1.0\text{ A}$ , $V_{CE} = 4.0\text{ Vdc}$ , $f = 1.0\text{ MHz}$ )	2N3055A, MJ15015 MJ15016	$f_T$	0.8 2.2	6.0 18	MHz
Output Capacitance ( $V_{CB} = 10\text{ Vdc}$ , $I_E = 0$ , $f = 1.0\text{ MHz}$ )		$C_{ob}$	60	600	pF

#### \*SWITCHING CHARACTERISTICS (2N3055A only)

RESISTIVE LOAD					
Delay Time	$(V_{CC} = 30\text{ Vdc}$ , $I_C = 4.0\text{ A}$ , $I_{B1} = I_{B2} = 0.4\text{ A}$ , $t_p = 25\text{ }\mu\text{s}$ Duty Cycle $\leq 2\%$ )	$t_d$	—	0.5	$\mu\text{s}$
Rise Time		$t_r$	—	4.0	$\mu\text{s}$
Storage Time		$t_s$	—	3.0	$\mu\text{s}$
Fall Time		$t_f$	—	6.0	$\mu\text{s}$

(1) Pulse Test: Pulse Width = 300  $\mu\text{s}$ , Duty Cycle  $\leq 2\%$ .

\*Indicates JEDEC Registered Data. (2N3055A)

2N3055A MJ15015 MJ15016

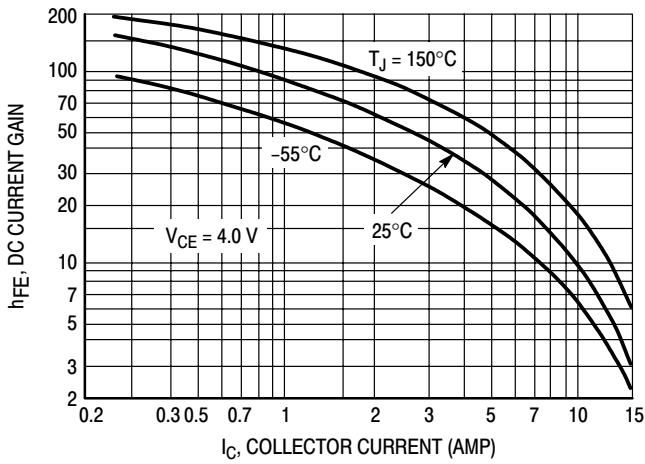

Figure 2. DC Current Gain

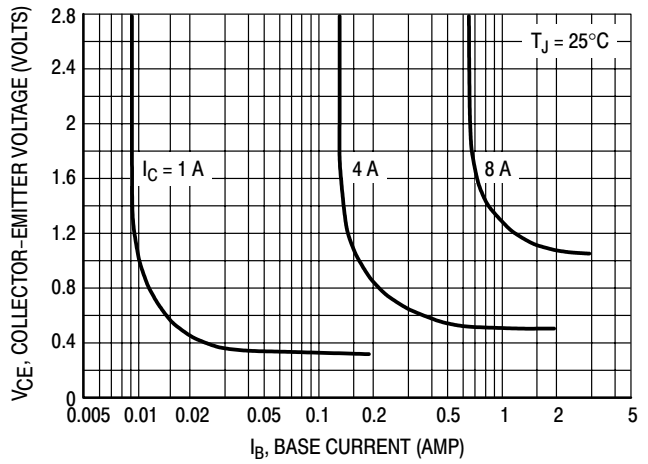

Figure 3. Collector Saturation Region

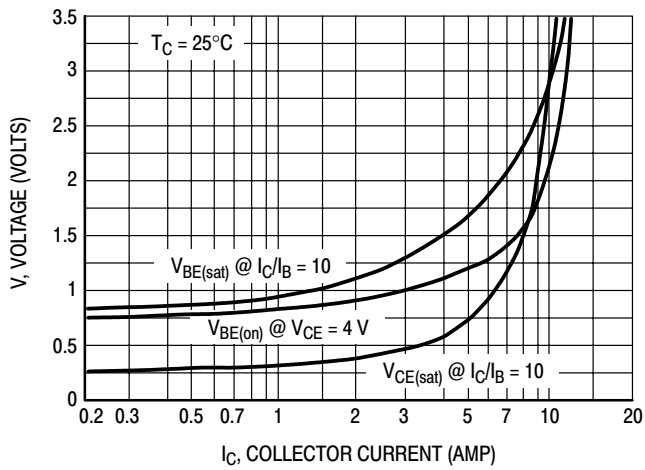

Figure 4. "On" Voltages

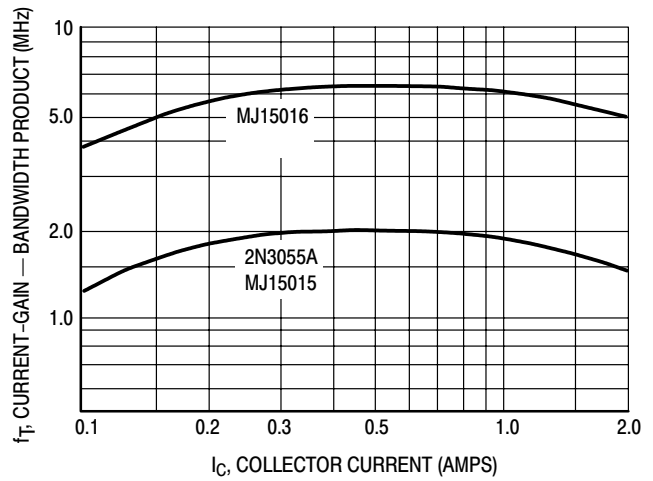

Figure 5. Current-Gain — Bandwidth Product

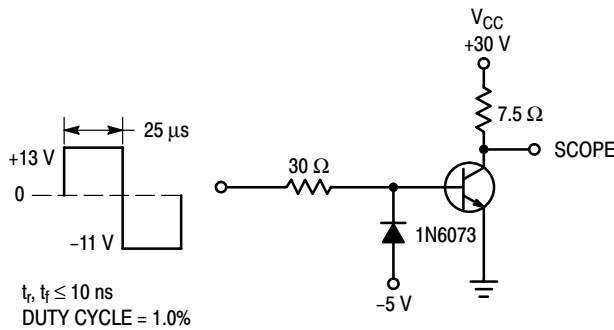

Figure 6. Switching Times Test Circuit (Circuit shown is for NPN)

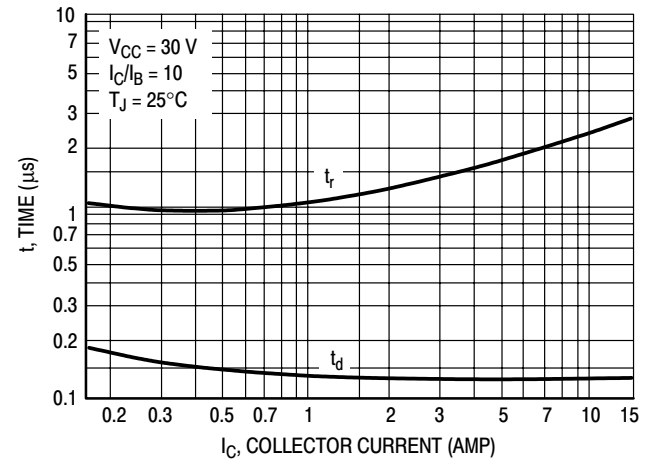
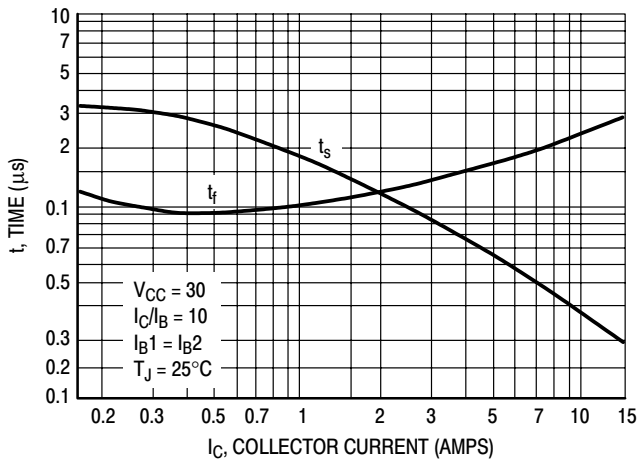
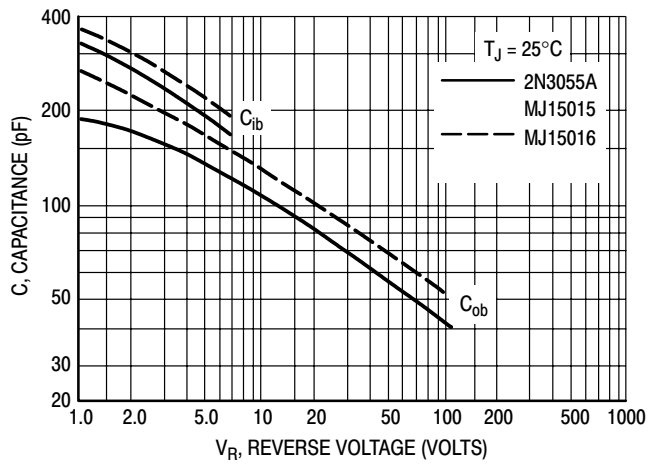

Figure 7. Turn-On Time

## 2N3055A MJ15015 MJ15016

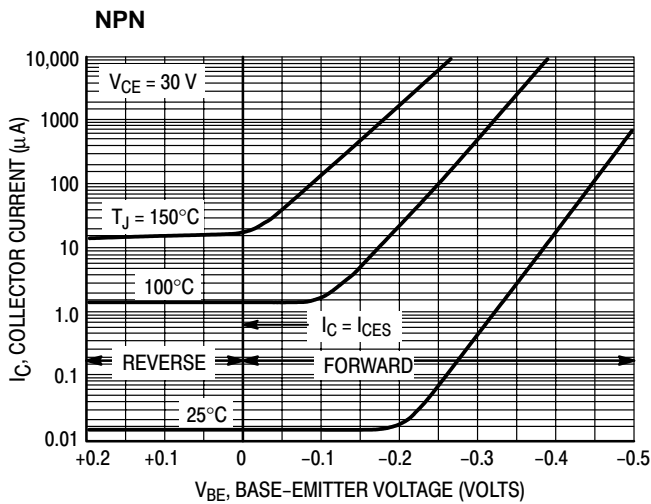

**Figure 8. Turn-Off Times**

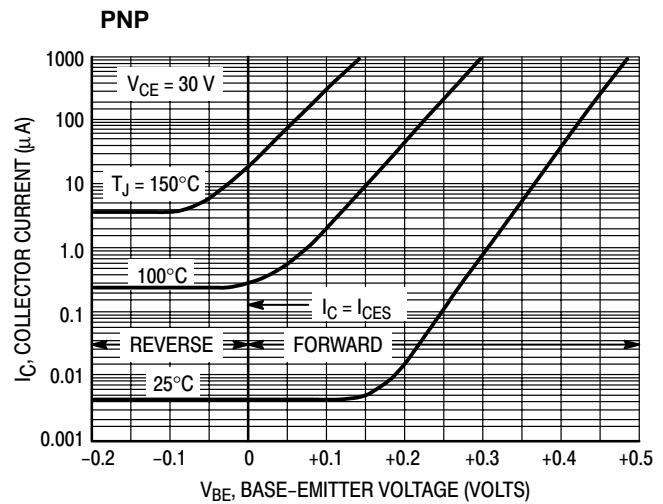

**Figure 9. Capacitances**

### COLLECTOR CUT-OFF REGION



**Figure 10. 2N3055A, MJ15015**



**Figure 11. MJ15016**

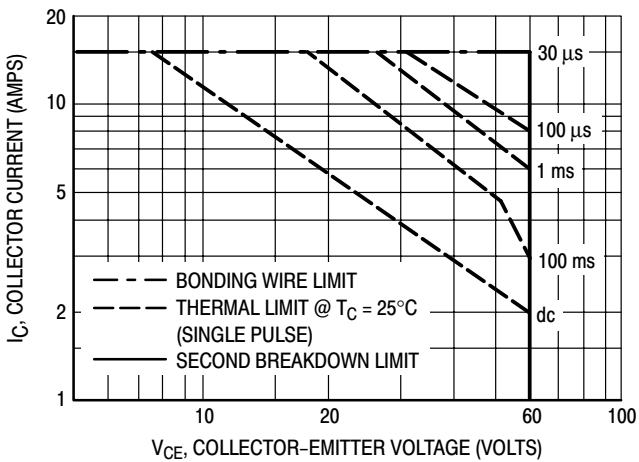

**Figure 12. Forward Bias Safe Operating Area  
2N3055A**

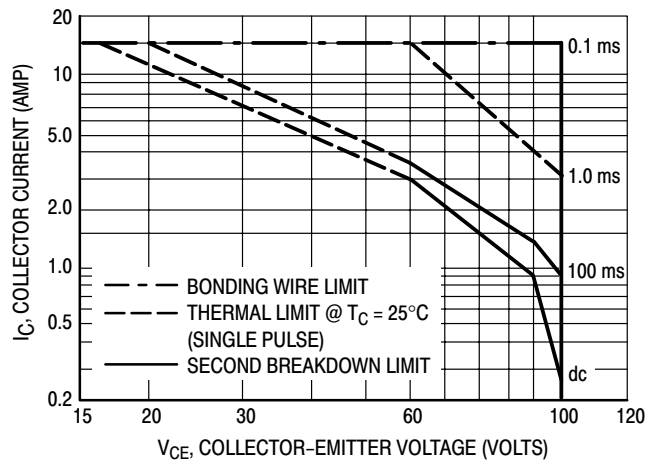

**Figure 13. Forward Bias Safe Operating Area  
MJ15015, MJ15016**

## 2N3055A MJ15015 MJ15016

There are two limitations on the power handling ability of a transistor: average junction temperature and second breakdown. Safe Operating area curves indicate  $I_C - V_{CE}$  limits of the transistor that must be observed for reliable operation; i.e., the transistor must not be subjected to greater dissipation than the curves indicate.

The data of Figures 12 and 13 is based on  $T_C = 25^\circ\text{C}$ ;  $T_{J(pk)}$  is variable depending on power level. Second breakdown pulse limits are valid for duty cycles to 10% but must be derated for temperature according to Figure 1.

# 2N3055A MJ15015 MJ15016

## PACKAGE DIMENSIONS

### CASE 1-07 TO-204AA (TO-3) ISSUE Z

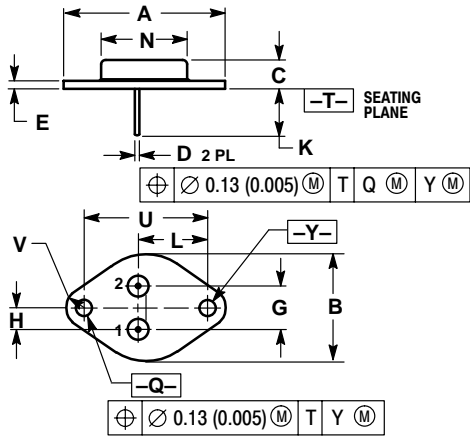

- NOTES:
1. DIMENSIONING AND TOLERANCING PER ANSI Y14.5M, 1982.
  2. CONTROLLING DIMENSION: INCH.
  3. ALL RULES AND NOTES ASSOCIATED WITH REFERENCED TO-204AA OUTLINE SHALL APPLY.

DIM	INCHES		MILLIMETERS	
	MIN	MAX	MIN	MAX
A	1.550 REF	---	39.37 REF	---
B	---	1.050	---	26.67
C	0.250	0.335	6.35	8.51
D	0.038	0.043	0.97	1.09
E	0.055	0.070	1.40	1.77
G	0.430 BSC	---	10.92 BSC	---
H	0.215 BSC	---	5.46 BSC	---
K	0.440	0.480	11.18	12.19
L	0.665 BSC	---	16.89 BSC	---
N	---	0.830	---	21.08
Q	0.151	0.165	3.84	4.19
U	1.187 BSC	---	30.15 BSC	---
V	0.131	0.188	3.33	4.77

STYLE 1:  
PIN 1: BASE  
2: EMITTER  
CASE: COLLECTOR

PowerBase is a trademark of Semiconductor Components Industries, LLC.

**ON Semiconductor** and  are trademarks of Semiconductor Components Industries, LLC (SCILLC). SCILLC reserves the right to make changes without further notice to any products herein. SCILLC makes no warranty, representation or guarantee regarding the suitability of its products for any particular purpose, nor does SCILLC assume any liability arising out of the application or use of any product or circuit, and specifically disclaims any and all liability, including without limitation special, consequential or incidental damages. "Typical" parameters which may be provided in SCILLC data sheets and/or specifications can and do vary in different applications and actual performance may vary over time. All operating parameters, including "Typicals" must be validated for each customer application by customer's technical experts. SCILLC does not convey any license under its patent rights nor the rights of others. SCILLC products are not designed, intended, or authorized for use as components in systems intended for surgical implant into the body, or other applications intended to support or sustain life, or for any other application in which the failure of the SCILLC product could create a situation where personal injury or death may occur. Should Buyer purchase or use SCILLC products for any such unintended or unauthorized application, Buyer shall indemnify and hold SCILLC and its officers, employees, subsidiaries, affiliates, and distributors harmless against all claims, costs, damages, and expenses, and reasonable attorney fees arising out of, directly or indirectly, any claim of personal injury or death associated with such unintended or unauthorized use, even if such claim alleges that SCILLC was negligent regarding the design or manufacture of the part. SCILLC is an Equal Opportunity/Affirmative Action Employer.

## PUBLICATION ORDERING INFORMATION

### **NORTH AMERICA Literature Fulfillment:**

Literature Distribution Center for ON Semiconductor  
P.O. Box 5163, Denver, Colorado 80217 USA  
**Phone:** 303-675-2175 or 800-344-3860 Toll Free USA/Canada  
**Fax:** 303-675-2176 or 800-344-3867 Toll Free USA/Canada  
**Email:** ONlit@hibbertco.com  
Fax Response Line: 303-675-2167 or 800-344-3810 Toll Free USA/Canada

**N. American Technical Support:** 800-282-9855 Toll Free USA/Canada

**EUROPE:** LDC for ON Semiconductor – European Support

**German Phone:** (+1) 303-308-7140 (Mon-Fri 2:30pm to 7:00pm CET)  
**Email:** ONlit-german@hibbertco.com  
**French Phone:** (+1) 303-308-7141 (Mon-Fri 2:00pm to 7:00pm CET)  
**Email:** ONlit-french@hibbertco.com  
**English Phone:** (+1) 303-308-7142 (Mon-Fri 12:00pm to 5:00pm GMT)  
**Email:** ONlit@hibbertco.com

**EUROPEAN TOLL-FREE ACCESS\*: 00-800-4422-3781**

\*Available from Germany, France, Italy, UK, Ireland

### **CENTRAL/SOUTH AMERICA:**

**Spanish Phone:** 303-308-7143 (Mon-Fri 8:00am to 5:00pm MST)  
**Email:** ONlit-spanish@hibbertco.com  
**Toll-Free from Mexico:** Dial 01-800-288-2872 for Access –  
then Dial 866-297-9322

**ASIA/PACIFIC:** LDC for ON Semiconductor – Asia Support

**Phone:** 1-303-675-2121 (Tue-Fri 9:00am to 1:00pm, Hong Kong Time)  
**Toll Free from Hong Kong & Singapore:**  
**001-800-4422-3781**  
**Email:** ONlit-asia@hibbertco.com

**JAPAN:** ON Semiconductor, Japan Customer Focus Center

4-32-1 Nishi-Gotanda, Shinagawa-ku, Tokyo, Japan 141-0031  
**Phone:** 81-3-5740-2700  
**Email:** r14525@onsemi.com

**ON Semiconductor Website:** <http://onsemi.com>

For additional information, please contact your local Sales Representative.