

Complementary Silicon Power Transistors

The 2N3773 and 2N6609 are PowerBase™ power transistors designed for high power audio, disk head positioners and other linear applications. These devices can also be used in power switching circuits such as relay or solenoid drivers, dc to dc converters or inverters.

- High Safe Operating Area (100% Tested) 150 W @ 100 V
- Completely Characterized for Linear Operation
- High DC Current Gain and Low Saturation Voltage
 - $h_{FE} = 15$ (Min) @ 8 A, 4 V
 - $V_{CE(sat)} = 1.4$ V (Max) @ $I_C = 8$ A, $I_B = 0.8$ A
- For Low Distortion Complementary Designs

NPN
2N3773*
PNP
2N6609

*ON Semiconductor Preferred Device

16 AMPERE
COMPLEMENTARY
POWER TRANSISTORS
140 VOLTS
150 WATTS

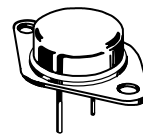

CASE 1-07
TO-204AA
(TO-3)

*MAXIMUM RATINGS

Rating	Symbol	Value	Unit
Collector Emitter Voltage	V_{CEO}	140	Vdc
Collector-Emitter Voltage	V_{CEX}	160	Vdc
Collector-Base Voltage	V_{CBO}	160	Vdc
Emitter-Base Voltage	V_{EBO}	7	Vdc
Collector Current — Continuous — Peak (1)	I_C	16 30	Adc
Base Current — Continuous — Peak (1)	I_B	4 15	Adc
Total Power Dissipation @ $T_C = 25^\circ\text{C}$ Derate above 25°C	P_D	150 0.855	Watts W/ $^\circ\text{C}$
Operating and Storage Junction Temperature Range	T_J, T_{stg}	-65 to +200	$^\circ\text{C}$

THERMAL CHARACTERISTICS

Characteristic	Symbol	Max	Unit
Thermal Resistance, Junction to Case	$R_{\theta JC}$	1.17	$^\circ\text{C/W}$

*Indicates JEDEC Registered Data.

(1) Pulse Test: Pulse Width = 5 ms, Duty Cycle \leq 10%.

Preferred devices are ON Semiconductor recommended choices for future use and best overall value.

2N3773 2N6609

ELECTRICAL CHARACTERISTICS ($T_C = 25^\circ\text{C}$ unless otherwise noted)

Characteristic	Symbol	Min	Max	Unit
----------------	--------	-----	-----	------

OFF CHARACTERISTICS (2)

*Collector–Emitter Breakdown Voltage ($I_C = 0.2\text{ Adc}$, $I_B = 0$)	$V_{CEO(sus)}$	140	—	Vdc
*Collector–Emitter Sustaining Voltage ($I_C = 0.1\text{ Adc}$, $V_{BE(off)} = 1.5\text{ Vdc}$, $R_{BE} = 100\text{ Ohms}$)	$V_{CEX(sus)}$	160	—	Vdc
Collector–Emitter Sustaining Voltage ($I_C = 0.2\text{ Adc}$, $R_{BE} = 100\text{ Ohms}$)	$V_{CER(sus)}$	150	—	Vdc
*Collector Cutoff Current ($V_{CE} = 120\text{ Vdc}$, $I_B = 0$)	I_{CEO}	—	10	mAdc
*Collector Cutoff Current ($V_{CE} = 140\text{ Vdc}$, $V_{BE(off)} = 1.5\text{ Vdc}$) ($V_{CE} = 140\text{ Vdc}$, $V_{BE(off)} = 1.5\text{ Vdc}$, $T_C = 150^\circ\text{C}$)	I_{CEX}	— —	2 10	mAdc
Collector Cutoff Current ($V_{CB} = 140\text{ Vdc}$, $I_E = 0$)	I_{CBO}	—	2	mAdc
*Emitter Cutoff Current ($V_{BE} = 7\text{ Vdc}$, $I_C = 0$)	I_{EBO}	—	5	mAdc

ON CHARACTERISTICS (2)

DC Current Gain *($I_C = 8\text{ Adc}$, $V_{CE} = 4\text{ Vdc}$) ($I_C = 16\text{ Adc}$, $V_{CE} = 4\text{ Vdc}$)	h_{FE}	15 5	60 —	—
Collector–Emitter Saturation Voltage *($I_C = 8\text{ Adc}$, $I_B = 800\text{ mAdc}$) ($I_C = 16\text{ Adc}$, $I_B = 3.2\text{ Adc}$)	$V_{CE(sat)}$	— —	1.4 4	Vdc
*Base–Emitter On Voltage ($I_C = 8\text{ Adc}$, $V_{CE} = 4\text{ Vdc}$)	$V_{BE(on)}$	—	2.2	Vdc

DYNAMIC CHARACTERISTICS

Magnitude of Common–Emitter Small–Signal, Short–Circuit, Forward Current Transfer Ratio ($I_C = 1\text{ A}$, $f = 50\text{ kHz}$)	$ h_{fe} $	4	—	—
*Small–Signal Current Gain ($I_C = 1\text{ Adc}$, $V_{CE} = 4\text{ Vdc}$, $f = 1\text{ kHz}$)	h_{fe}	40	—	—

SECOND BREAKDOWN CHARACTERISTICS

Second Breakdown Collector Current with Base Forward Biased $t = 1\text{ s}$ (non–repetitive), $V_{CE} = 100\text{ V}$, See Figure 12	$I_{S/b}$	1.5	—	Adc
---	-----------	-----	---	-----

(2) Pulse Test: Pulse Width = 300 μs , Duty Cycle $\leq 2\%$.

*Indicates JEDEC Registered Data.

NPN

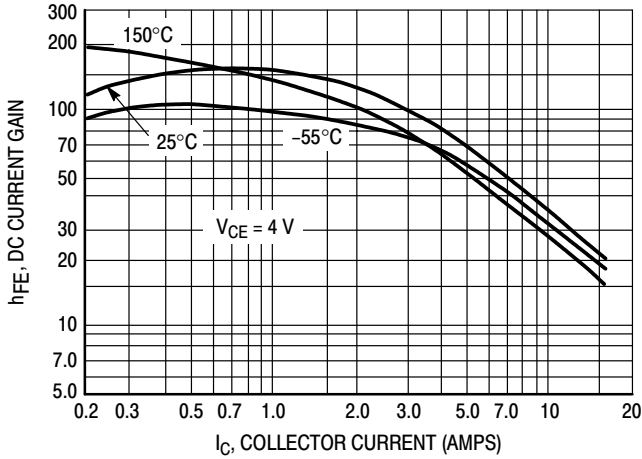

Figure 6. DC Current Gain

PNP

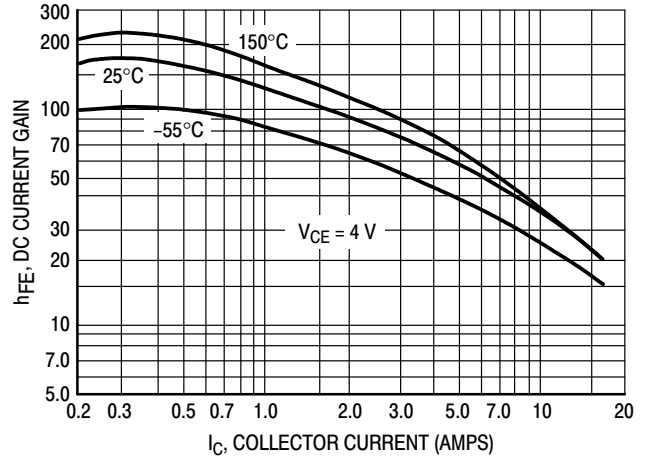

Figure 7. DC Current Gain

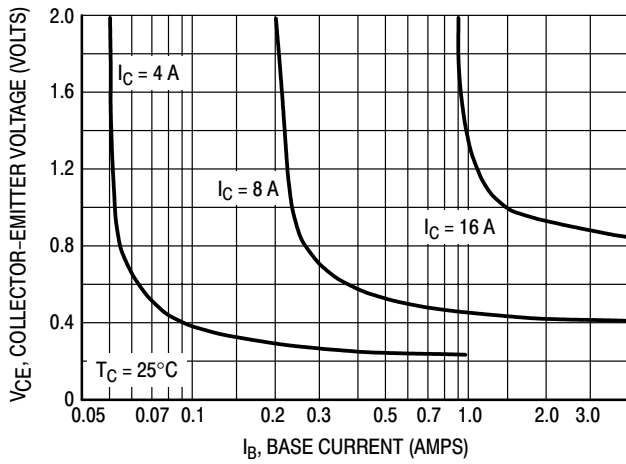

Figure 8. Collector Saturation Region

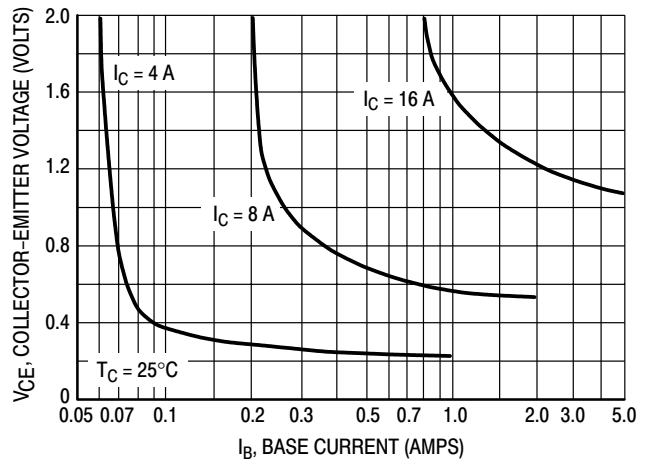

Figure 9. Collector Saturation Region

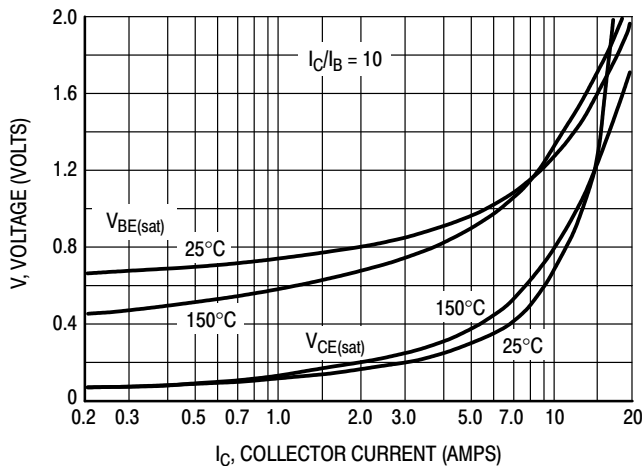

Figure 10. "On" Voltage

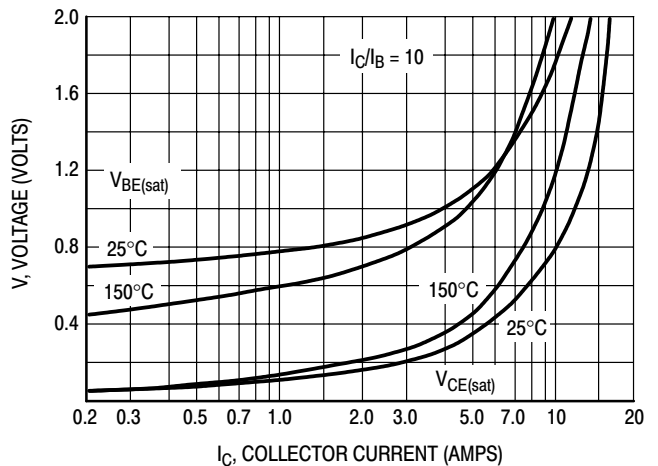

Figure 11. "On" Voltage

2N3773 2N6609

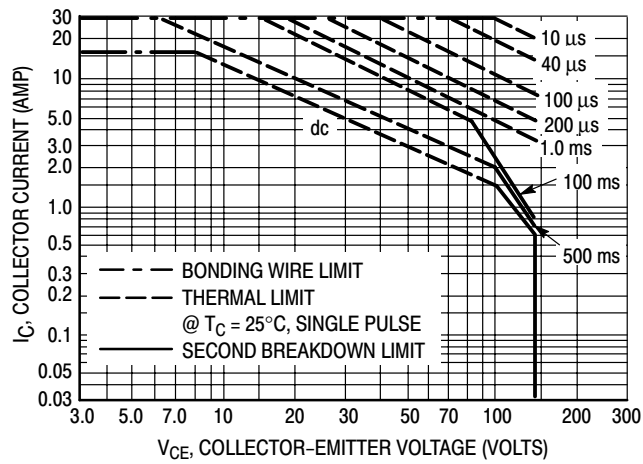

Figure 12. Forward Bias Safe Operating Area

There are two limitations on the power handling ability of a transistor: average junction temperature and second breakdown. Safe operating area curves indicate $I_C - V_{CE}$ limits of the transistor that must be observed for reliable operation: i.e., the transistor must not be subjected to greater dissipation than the curves indicate.

The data of Figure 7 is based on $T_{J(pk)} = 200^\circ\text{C}$; T_C is variable depending on conditions. Second breakdown pulse

limits are valid for duty cycles to 10% provided $T_{J(pk)} < 200^\circ\text{C}$. At high case temperatures, thermal limitations will reduce the power that can be handled to values less than the limitations imposed by second breakdown.

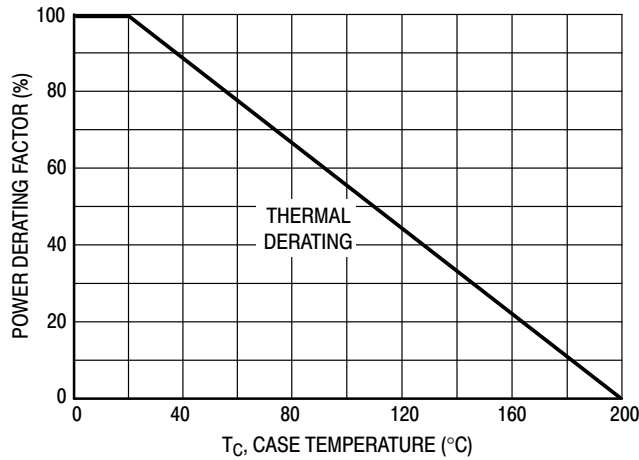
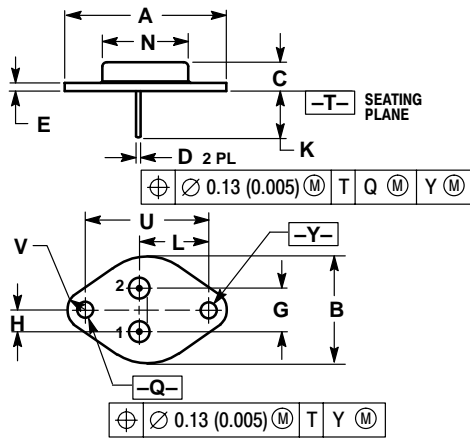

Figure 13. Power Derating

2N3773 2N6609

PACKAGE DIMENSIONS

CASE 1-07 TO-204AA (TO-3) ISSUE Z



- NOTES:
1. DIMENSIONING AND TOLERANCING PER ANSI Y14.5M, 1982.
 2. CONTROLLING DIMENSION: INCH.
 3. ALL RULES AND NOTES ASSOCIATED WITH REFERENCED TO-204AA OUTLINE SHALL APPLY.

DIM	INCHES		MILLIMETERS	
	MIN	MAX	MIN	MAX
A	---	1.550 REF	---	39.37 REF
B	---	1.050	---	26.67
C	0.250	0.335	6.35	8.51
D	0.038	0.043	0.97	1.09
E	0.055	0.070	1.40	1.77
G	0.430 BSC		10.92 BSC	
H	0.215 BSC		5.46 BSC	
K	0.440	0.480	11.18	12.19
L	0.665 BSC		16.89 BSC	
N	---	0.830	---	21.08
Q	0.151	0.165	3.84	4.19
U	1.187 BSC		30.15 BSC	
V	0.131	0.188	3.33	4.77

STYLE 1:
PIN 1: BASE
2: EMITTER
CASE: COLLECTOR

Notes

Notes

PowerBase is a trademark of Semiconductor Components Industries, LLC.

ON Semiconductor and  are trademarks of Semiconductor Components Industries, LLC (SCILLC). SCILLC reserves the right to make changes without further notice to any products herein. SCILLC makes no warranty, representation or guarantee regarding the suitability of its products for any particular purpose, nor does SCILLC assume any liability arising out of the application or use of any product or circuit, and specifically disclaims any and all liability, including without limitation special, consequential or incidental damages. "Typical" parameters which may be provided in SCILLC data sheets and/or specifications can and do vary in different applications and actual performance may vary over time. All operating parameters, including "Typicals" must be validated for each customer application by customer's technical experts. SCILLC does not convey any license under its patent rights nor the rights of others. SCILLC products are not designed, intended, or authorized for use as components in systems intended for surgical implant into the body, or other applications intended to support or sustain life, or for any other application in which the failure of the SCILLC product could create a situation where personal injury or death may occur. Should Buyer purchase or use SCILLC products for any such unintended or unauthorized application, Buyer shall indemnify and hold SCILLC and its officers, employees, subsidiaries, affiliates, and distributors harmless against all claims, costs, damages, and expenses, and reasonable attorney fees arising out of, directly or indirectly, any claim of personal injury or death associated with such unintended or unauthorized use, even if such claim alleges that SCILLC was negligent regarding the design or manufacture of the part. SCILLC is an Equal Opportunity/Affirmative Action Employer.

PUBLICATION ORDERING INFORMATION

NORTH AMERICA Literature Fulfillment:

Literature Distribution Center for ON Semiconductor
P.O. Box 5163, Denver, Colorado 80217 USA
Phone: 303-675-2175 or 800-344-3860 Toll Free USA/Canada
Fax: 303-675-2176 or 800-344-3867 Toll Free USA/Canada
Email: ONlit@hibbertco.com
Fax Response Line: 303-675-2167 or 800-344-3810 Toll Free USA/Canada

N. American Technical Support: 800-282-9855 Toll Free USA/Canada

EUROPE: LDC for ON Semiconductor – European Support

German Phone: (+1) 303-308-7140 (Mon-Fri 2:30pm to 7:00pm CET)
Email: ONlit-german@hibbertco.com
French Phone: (+1) 303-308-7141 (Mon-Fri 2:00pm to 7:00pm CET)
Email: ONlit-french@hibbertco.com
English Phone: (+1) 303-308-7142 (Mon-Fri 12:00pm to 5:00pm GMT)
Email: ONlit@hibbertco.com

EUROPEAN TOLL-FREE ACCESS*: 00-800-4422-3781

*Available from Germany, France, Italy, UK, Ireland

CENTRAL/SOUTH AMERICA:

Spanish Phone: 303-308-7143 (Mon-Fri 8:00am to 5:00pm MST)
Email: ONlit-spanish@hibbertco.com
Toll-Free from Mexico: Dial 01-800-288-2872 for Access –
then Dial 866-297-9322

ASIA/PACIFIC: LDC for ON Semiconductor – Asia Support

Phone: 1-303-675-2121 (Tue-Fri 9:00am to 1:00pm, Hong Kong Time)
Toll Free from Hong Kong & Singapore:
001-800-4422-3781
Email: ONlit-asia@hibbertco.com

JAPAN: ON Semiconductor, Japan Customer Focus Center
4-32-1 Nishi-Gotanda, Shinagawa-ku, Tokyo, Japan 141-0031
Phone: 81-3-5740-2700
Email: r14525@onsemi.com

ON Semiconductor Website: <http://onsemi.com>

For additional information, please contact your local Sales Representative.