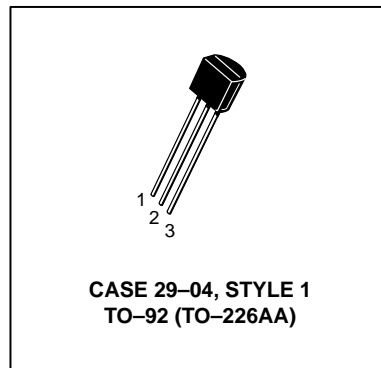
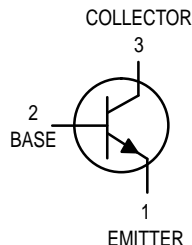


# Amplifier Transistors

## NPN Silicon

**2N5209**  
**2N5210**



### MAXIMUM RATINGS

Rating	Symbol	Value	Unit
Collector–Emitter Voltage	$V_{CEO}$	50	Vdc
Collector–Base Voltage	$V_{CBO}$	50	Vdc
Emitter–Base Voltage	$V_{EBO}$	4.0	Vdc
Collector Current — Continuous	$I_C$	50	mAdc
Total Device Dissipation @ $T_A = 25^\circ\text{C}$ Derate above $25^\circ\text{C}$	$P_D$	625 5.0	mW mW/ $^\circ\text{C}$
Total Device Dissipation @ $T_C = 25^\circ\text{C}$ Derate above $25^\circ\text{C}$	$P_D$	1.5 12	Watts mW/ $^\circ\text{C}$
Operating and Storage Junction Temperature Range	$T_J, T_{stg}$	-55 to +150	$^\circ\text{C}$

### THERMAL CHARACTERISTICS

Characteristic	Symbol	Max	Unit
Thermal Resistance, Junction to Ambient	$R_{\theta JA}$	200	$^\circ\text{C}/\text{W}$
Thermal Resistance, Junction to Case	$R_{\theta JC}$	83.3	$^\circ\text{C}/\text{W}$

### ELECTRICAL CHARACTERISTICS ( $T_A = 25^\circ\text{C}$ unless otherwise noted)

Characteristic	Symbol	Min	Max	Unit
----------------	--------	-----	-----	------

### OFF CHARACTERISTICS

Collector–Emitter Breakdown Voltage ( $I_C = 1.0 \text{ mAdc}, I_B = 0$ )	$V_{(BR)CEO}$	50	—	Vdc
Collector–Base Breakdown Voltage ( $I_C = 0.1 \text{ mAdc}, I_E = 0$ )	$V_{(BR)CBO}$	50	—	Vdc
Collector Cutoff Current ( $V_{CB} = 35 \text{ Vdc}, I_E = 0$ )	$I_{CBO}$	—	50	nAdc
Emitter Cutoff Current ( $V_{EB} = 3.0 \text{ Vdc}, I_C = 0$ )	$I_{EBO}$	—	50	nAdc

## 2N5209 2N5210

### ELECTRICAL CHARACTERISTICS ( $T_A = 25^\circ\text{C}$ unless otherwise noted) (Continued)

Characteristic	Symbol	Min	Max	Unit
<b>ON CHARACTERISTICS</b>				
DC Current Gain ( $I_C = 100\ \mu\text{Adc}$ , $V_{CE} = 5.0\ \text{Vdc}$ )	$h_{FE}$	100	300	—
	2N5209	200	600	
	2N5210			
( $I_C = 1.0\ \text{mAdc}$ , $V_{CE} = 5.0\ \text{Vdc}$ )		150	—	
	2N5209	250	—	
	2N5210			
( $I_C = 10\ \text{mAdc}$ , $V_{CE} = 5.0\ \text{Vdc}$ ) <sup>(1)</sup>		150	—	
	2N5209	250	—	
	2N5210			
Collector–Emitter Saturation Voltage ( $I_C = 10\ \text{mAdc}$ , $I_B = 1.0\ \text{mAdc}$ )	$V_{CE(sat)}$	—	0.7	Vdc
Base–Emitter On Voltage ( $I_C = 1.0\ \text{mAdc}$ , $V_{CE} = 5.0\ \text{mAdc}$ )	$V_{BE(on)}$	—	0.85	Vdc
<b>SMALL–SIGNAL CHARACTERISTICS</b>				
Current–Gain — Bandwidth Product ( $I_C = 500\ \mu\text{Adc}$ , $V_{CE} = 5.0\ \text{Vdc}$ , $f = 20\ \text{MHz}$ )	$f_T$	30	—	MHz
Collector–Base Capacitance ( $V_{CB} = 5.0\ \text{Vdc}$ , $I_E = 0$ , $f = 1.0\ \text{MHz}$ )	$C_{cb}$	—	4.0	pF
Small–Signal Current Gain ( $I_C = 1.0\ \text{mAdc}$ , $V_{CE} = 5.0\ \text{Vdc}$ , $f = 1.0\ \text{kHz}$ )	$h_{fe}$	150	600	—
	2N5209	250	900	
	2N5210			
Noise Figure ( $I_C = 20\ \mu\text{Adc}$ , $V_{CE} = 5.0\ \text{Vdc}$ , $R_S = 22\ \text{k}\Omega$ , $f = 1.0\ \text{kHz}$ )	NF	—	3.0	dB
	2N5209	—	2.0	
	2N5210			
( $I_C = 20\ \mu\text{Adc}$ , $V_{CE} = 5.0\ \text{Vdc}$ , $R_S = 10\ \text{k}\Omega$ , $f = 1.0\ \text{kHz}$ )		—	4.0	
	2N5209	—	3.0	
	2N5210			

1. Pulse Test: Pulse Width = 300  $\mu\text{s}$ , Duty Cycle = 2.0%.

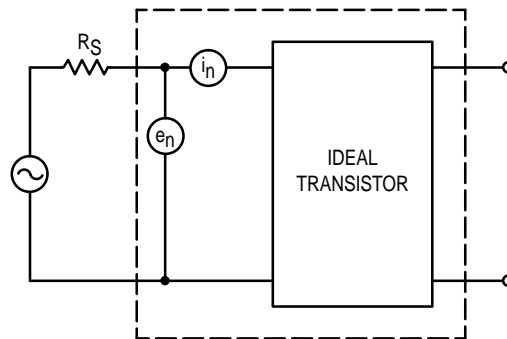
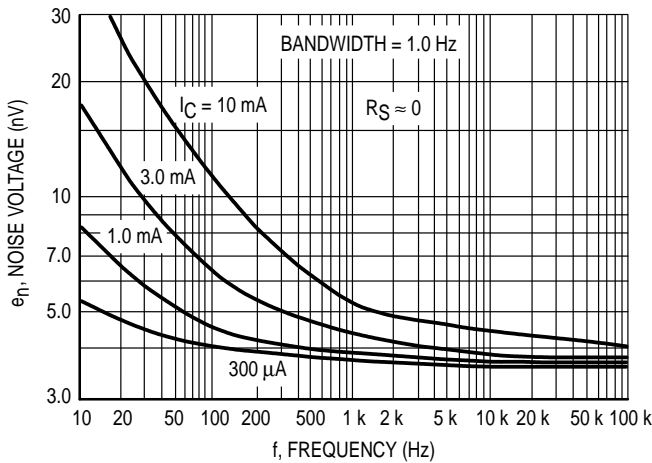


Figure 1. Transistor Noise Model

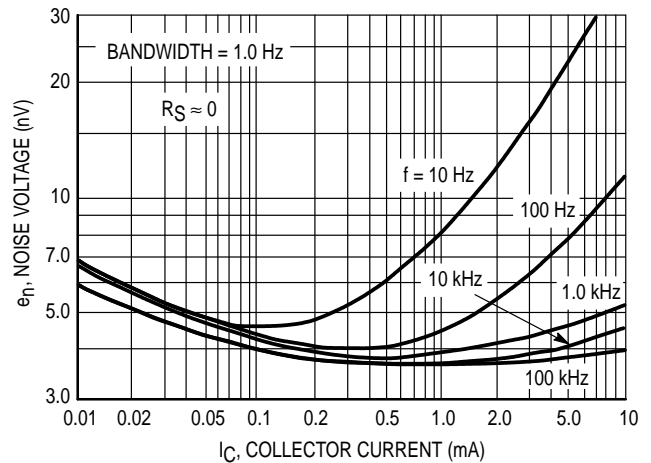
**NOISE CHARACTERISTICS**

( $V_{CE} = 5.0 \text{ Vdc}$ ,  $T_A = 25^\circ\text{C}$ )

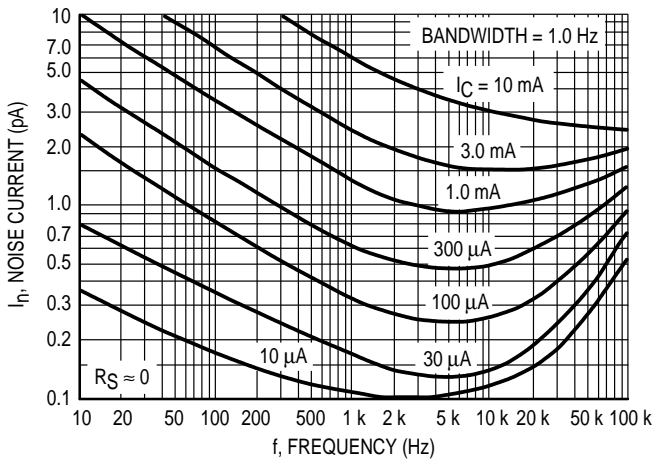
**NOISE VOLTAGE**



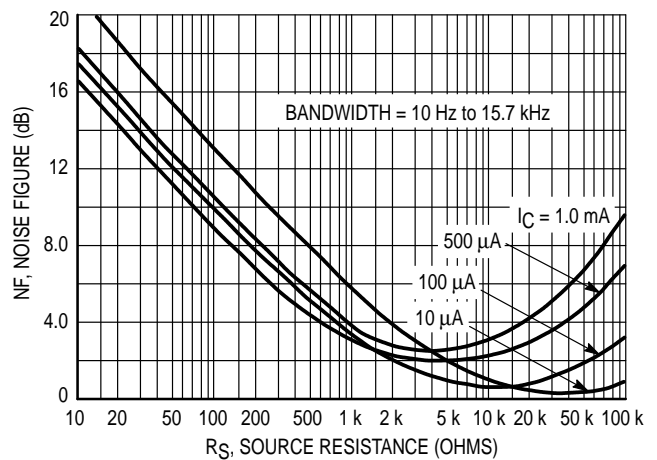
**Figure 2. Effects of Frequency**



**Figure 3. Effects of Collector Current**

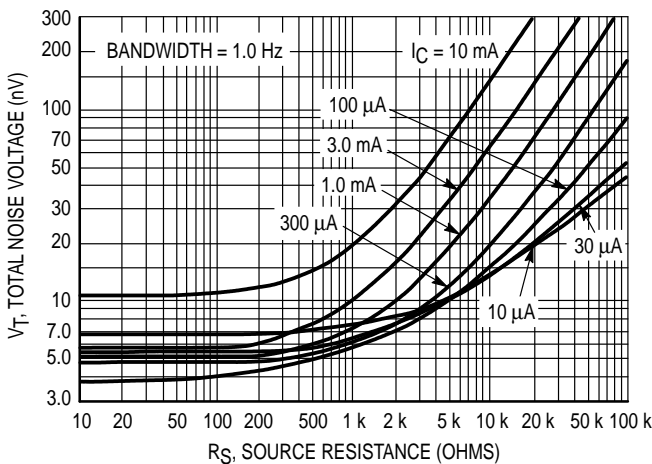


**Figure 4. Noise Current**

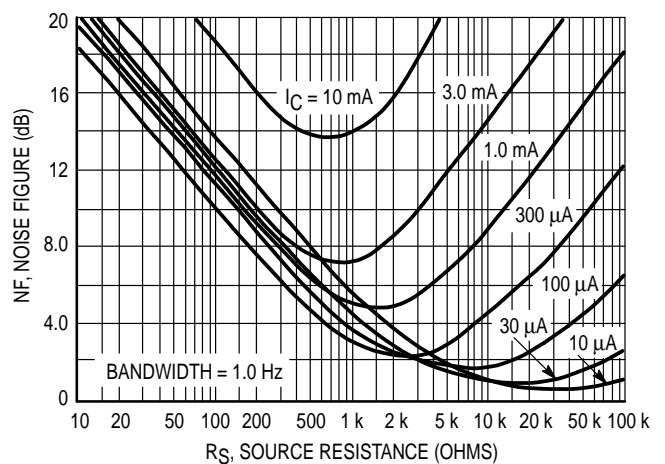


**Figure 5. Wideband Noise Figure**

**100 Hz NOISE DATA**



**Figure 6. Total Noise Voltage**



**Figure 7. Noise Figure**

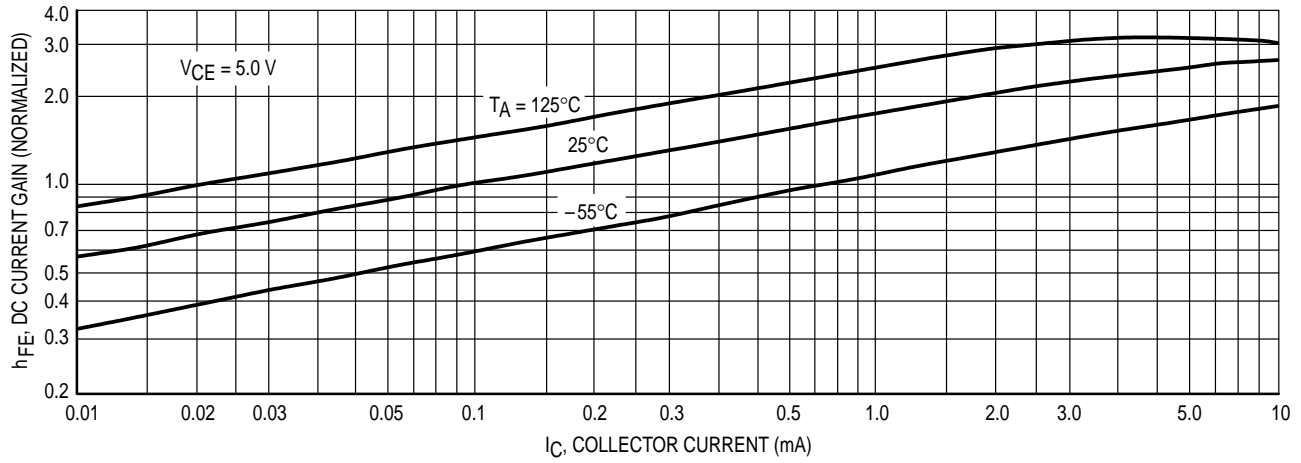


Figure 8. DC Current Gain

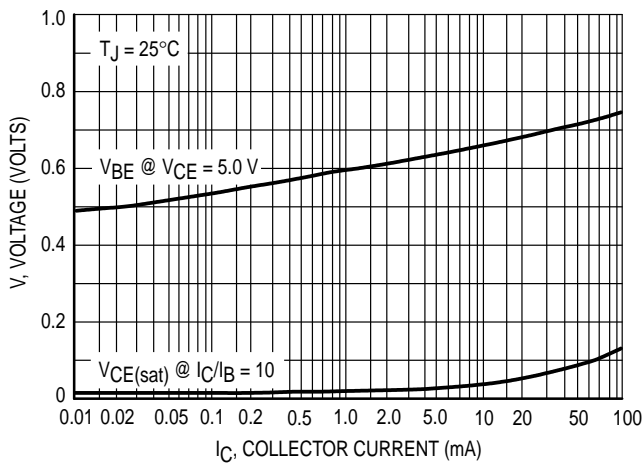


Figure 9. "On" Voltages

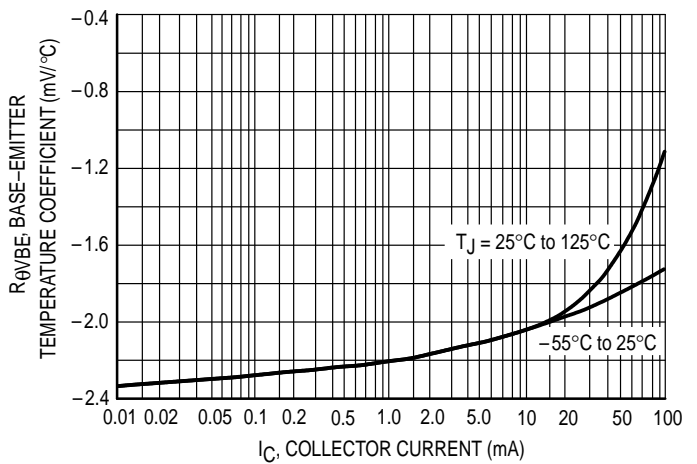


Figure 10. Temperature Coefficients

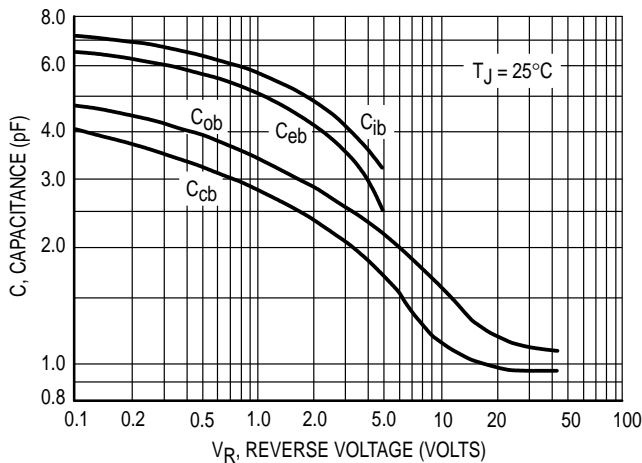


Figure 11. Capacitance

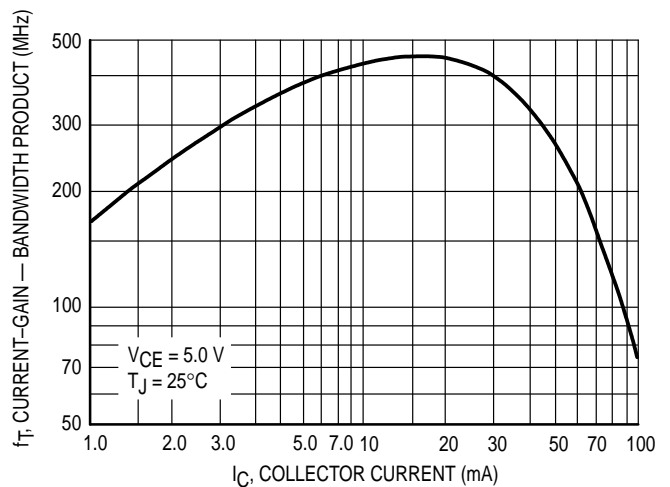
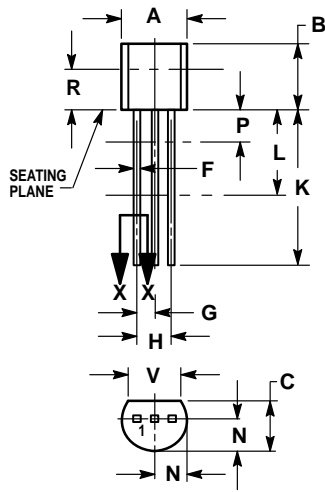


Figure 12. Current-Gain — Bandwidth Product

PACKAGE DIMENSIONS




**CASE 029-04  
(TO-226AA)  
ISSUE AD**

- NOTES:
1. DIMENSIONING AND TOLERANCING PER ANSI Y14.5M, 1982.
  2. CONTROLLING DIMENSION: INCH.
  3. CONTOUR OF PACKAGE BEYOND DIMENSION R IS UNCONTROLLED.
  4. DIMENSION F APPLIES BETWEEN P AND L. DIMENSION D AND J APPLY BETWEEN L AND K. MINIMUM LEAD DIMENSION IS UNCONTROLLED IN P AND BEYOND DIMENSION K MINIMUM.

DIM	INCHES		MILLIMETERS	
	MIN	MAX	MIN	MAX
A	0.175	0.205	4.45	5.20
B	0.170	0.210	4.32	5.33
C	0.125	0.165	3.18	4.19
D	0.016	0.022	0.41	0.55
F	0.016	0.019	0.41	0.48
G	0.045	0.055	1.15	1.39
H	0.095	0.105	2.42	2.66
J	0.015	0.020	0.39	0.50
K	0.500	—	12.70	—
L	0.250	—	6.35	—
N	0.080	0.105	2.04	2.66
P	—	0.100	—	2.54
R	0.115	—	2.93	—
V	0.135	—	3.43	—

- STYLE 1:  
PIN 1. EMITTER  
2. BASE  
3. COLLECTOR

Motorola reserves the right to make changes without further notice to any products herein. Motorola makes no warranty, representation or guarantee regarding the suitability of its products for any particular purpose, nor does Motorola assume any liability arising out of the application or use of any product or circuit, and specifically disclaims any and all liability, including without limitation consequential or incidental damages. "Typical" parameters can and do vary in different applications. All operating parameters, including "Typicals" must be validated for each customer application by customer's technical experts. Motorola does not convey any license under its patent rights nor the rights of others. Motorola products are not designed, intended, or authorized for use as components in systems intended for surgical implant into the body, or other applications intended to support or sustain life, or for any other application in which the failure of the Motorola product could create a situation where personal injury or death may occur. Should Buyer purchase or use Motorola products for any such unintended or unauthorized application, Buyer shall indemnify and hold Motorola and its officers, employees, subsidiaries, affiliates, and distributors harmless against all claims, costs, damages, and expenses, and reasonable attorney fees arising out of, directly or indirectly, any claim of personal injury or death associated with such unintended or unauthorized use, even if such claim alleges that Motorola was negligent regarding the design or manufacture of the part. Motorola and  are registered trademarks of Motorola, Inc. Motorola, Inc. is an Equal Opportunity/Affirmative Action Employer.

**How to reach us:**

**USA/EUROPE:** Motorola Literature Distribution;  
P.O. Box 20912; Phoenix, Arizona 85036. 1-800-441-2447

**JAPAN:** Nippon Motorola Ltd.; Tatsumi-SPD-JLDC, Toshikatsu Otsuki,  
6F Seibu-Butsuryu-Center, 3-14-2 Tatsumi Koto-Ku, Tokyo 135, Japan. 03-3521-8315

**MFAX:** RMFAX0@email.sps.mot.com – TOUCHTONE (602) 244-6609  
**INTERNET:** <http://Design-NET.com>

**HONG KONG:** Motorola Semiconductors H.K. Ltd.; 8B Tai Ping Industrial Park,  
51 Ting Kok Road, Tai Po, N.T., Hong Kong. 852-26629298

