

# Amplifier Transistors

## PNP Silicon

**2N5400**  
**2N5401\***

\*Motorola Preferred Device

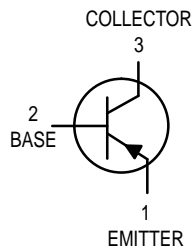

CASE 29-04, STYLE 1  
TO-92 (TO-226AA)

### MAXIMUM RATINGS

Rating	Symbol	2N5400	2N5401	Unit
Collector–Emitter Voltage	$V_{CEO}$	120	150	Vdc
Collector–Base Voltage	$V_{CBO}$	130	160	Vdc
Emitter–Base Voltage	$V_{EBO}$	5.0		Vdc
Collector Current — Continuous	$I_C$	600		mAdc
Total Device Dissipation @ $T_A = 25^\circ\text{C}$ Derate above $25^\circ\text{C}$	$P_D$	625	5.0	mW mW/ $^\circ\text{C}$
Total Device Dissipation @ $T_C = 25^\circ\text{C}$ Derate above $25^\circ\text{C}$	$P_D$	1.5	12	Watts mW/ $^\circ\text{C}$
Operating and Storage Junction Temperature Range	$T_J, T_{stg}$	–55 to +150		$^\circ\text{C}$

### THERMAL CHARACTERISTICS

Characteristic	Symbol	Max	Unit
Thermal Resistance, Junction to Ambient	$R_{\theta JA}$	200	$^\circ\text{C}/\text{W}$
Thermal Resistance, Junction to Case	$R_{\theta JC}$	83.3	$^\circ\text{C}/\text{W}$

### ELECTRICAL CHARACTERISTICS ( $T_A = 25^\circ\text{C}$ unless otherwise noted)

Characteristic	Symbol	Min	Max	Unit
----------------	--------	-----	-----	------

### OFF CHARACTERISTICS

Collector–Emitter Breakdown Voltage <sup>(1)</sup> ( $I_C = 1.0 \text{ mAdc}, I_E = 0$ )	$V_{(BR)CEO}$	120 150	— —	Vdc
Collector–Base Breakdown Voltage ( $I_C = 100 \mu\text{Adc}, I_E = 0$ )	$V_{(BR)CBO}$	130 160	— —	Vdc
Emitter–Base Breakdown Voltage ( $I_E = 10 \mu\text{Adc}, I_C = 0$ )	$V_{(BR)EBO}$	5.0	—	Vdc
Collector Cutoff Current ( $V_{CB} = 100 \text{ Vdc}, I_E = 0$ ) ( $V_{CB} = 120 \text{ Vdc}, I_E = 0$ ) ( $V_{CB} = 100 \text{ Vdc}, I_E = 0, T_A = 100^\circ\text{C}$ ) ( $V_{CB} = 120 \text{ Vdc}, I_E = 0, T_A = 100^\circ\text{C}$ )	$I_{CBO}$	— — — —	100 50 100 50	nAdc $\mu\text{Adc}$
Emitter Cutoff Current ( $V_{EB} = 3.0 \text{ Vdc}, I_C = 0$ )	$I_{EBO}$	—	50	nAdc

1. Pulse Test: Pulse Width = 300  $\mu\text{s}$ , Duty Cycle = 2.0%.

Preferred devices are Motorola recommended choices for future use and best overall value.

**2N5400 2N5401****ELECTRICAL CHARACTERISTICS** ( $T_A = 25^\circ\text{C}$  unless otherwise noted) (Continued)

Characteristic		Symbol	Min	Max	Unit
<b>ON CHARACTERISTICS(1)</b>					
DC Current Gain ( $I_C = 1.0 \text{ mAdc}$ , $V_{CE} = 5.0 \text{ Vdc}$ )  ( $I_C = 10 \text{ mAdc}$ , $V_{CE} = 5.0 \text{ Vdc}$ )  ( $I_C = 50 \text{ mAdc}$ , $V_{CE} = 5.0 \text{ Vdc}$ )	2N5400	$h_{FE}$	30	—	—
	2N5401		50	—	—
	2N5400		40	180	—
	2N5401		60	240	—
	2N5400		40	—	—
	2N5401		50	—	—
Collector–Emitter Saturation Voltage ( $I_C = 10 \text{ mAdc}$ , $I_B = 1.0 \text{ mAdc}$ ) ( $I_C = 50 \text{ mAdc}$ , $I_B = 5.0 \text{ mAdc}$ )		$V_{CE(sat)}$	—	0.2 0.5	Vdc
Base–Emitter Saturation Voltage ( $I_C = 10 \text{ mAdc}$ , $I_B = 1.0 \text{ mAdc}$ ) ( $I_C = 50 \text{ mAdc}$ , $I_B = 5.0 \text{ mAdc}$ )		$V_{BE(sat)}$	—	1.0 1.0	Vdc
<b>SMALL–SIGNAL CHARACTERISTICS</b>					
Current–Gain — Bandwidth Product ( $I_C = 10 \text{ mAdc}$ , $V_{CE} = 10 \text{ Vdc}$ , $f = 100 \text{ MHz}$ )	2N5400 2N5401	$f_T$	100 100	400 300	MHz
Output Capacitance ( $V_{CB} = 10 \text{ Vdc}$ , $I_E = 0$ , $f = 1.0 \text{ MHz}$ )		$C_{obo}$	—	6.0	pF
Small–Signal Current Gain ( $I_C = 1.0 \text{ mAdc}$ , $V_{CE} = 10 \text{ Vdc}$ , $f = 1.0 \text{ kHz}$ )	2N5400 2N5401	$h_{fe}$	30 40	200 200	—
Noise Figure ( $I_C = 250 \mu\text{Adc}$ , $V_{CE} = 5.0 \text{ Vdc}$ , $R_S = 1.0 \text{ k}\Omega$ , $f = 1.0 \text{ kHz}$ )		NF	—	8.0	dB

1. Pulse Test: Pulse Width = 300  $\mu\text{s}$ , Duty Cycle = 2.0%.

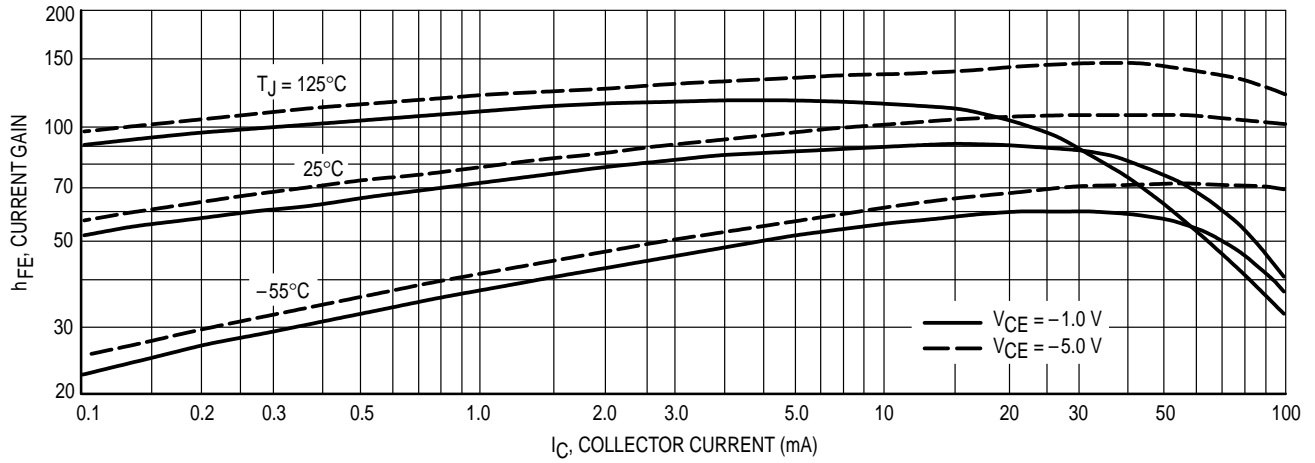

Figure 1. DC Current Gain

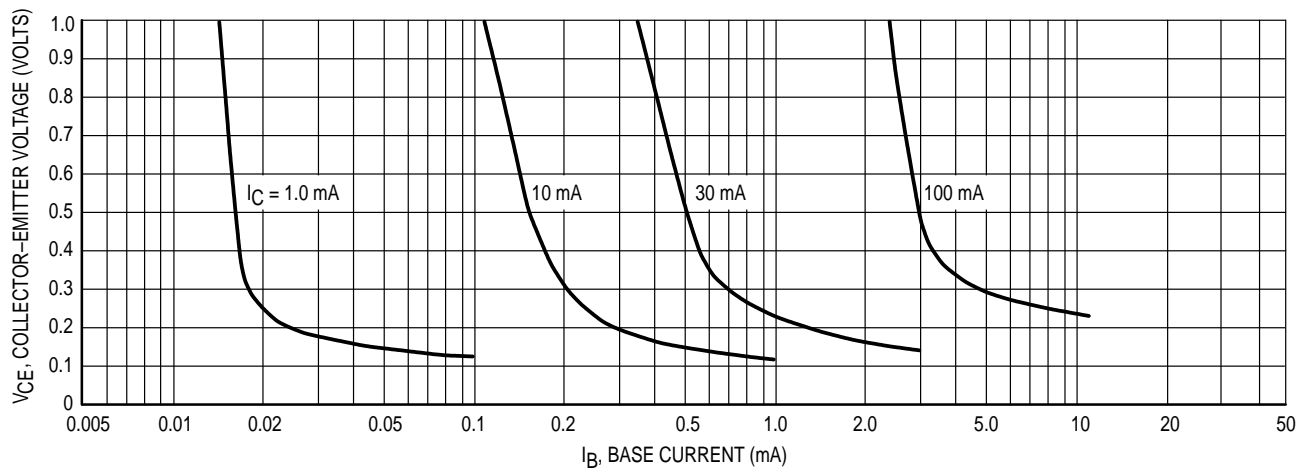

Figure 2. Collector Saturation Region

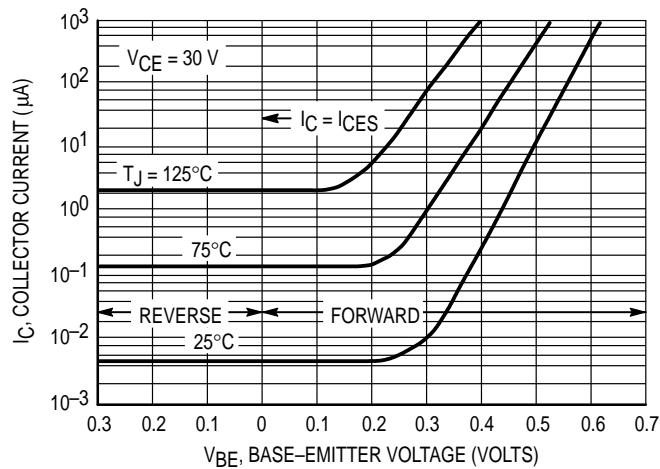

Figure 3. Collector Cut-Off Region

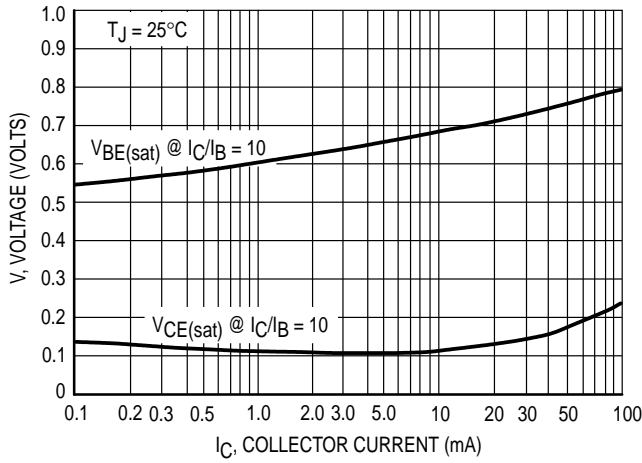

Figure 4. "On" Voltages

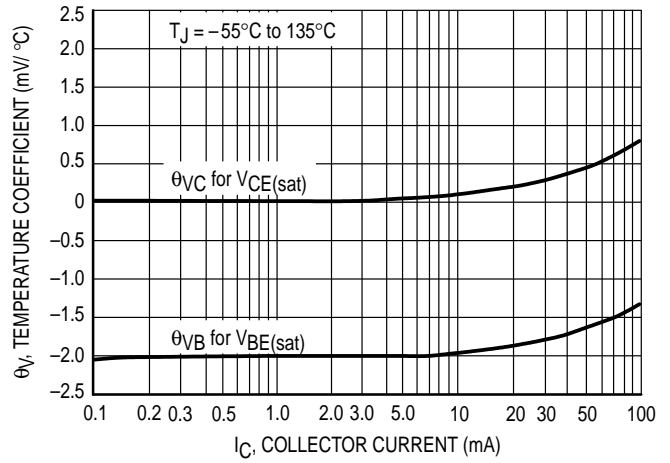

Figure 5. Temperature Coefficients

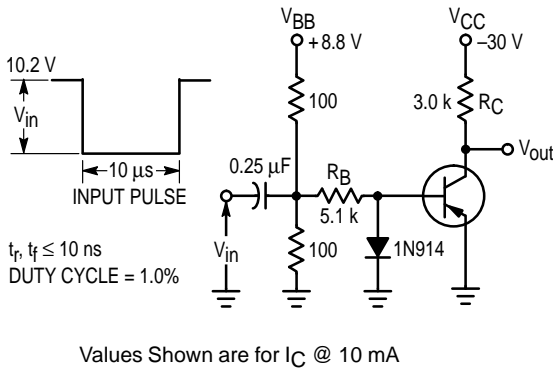

Figure 6. Switching Time Test Circuit

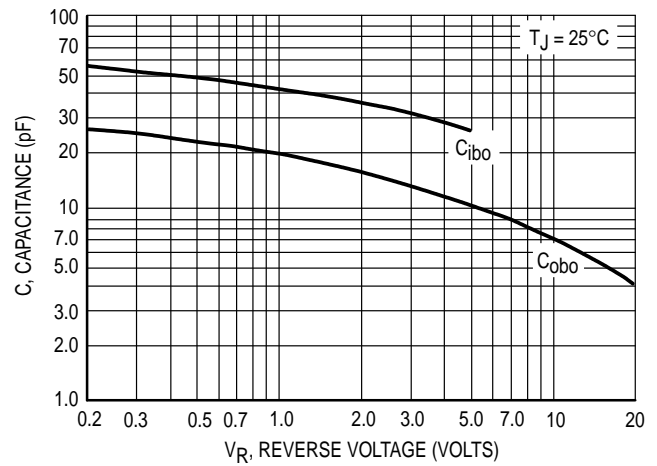

Figure 7. Capacitances

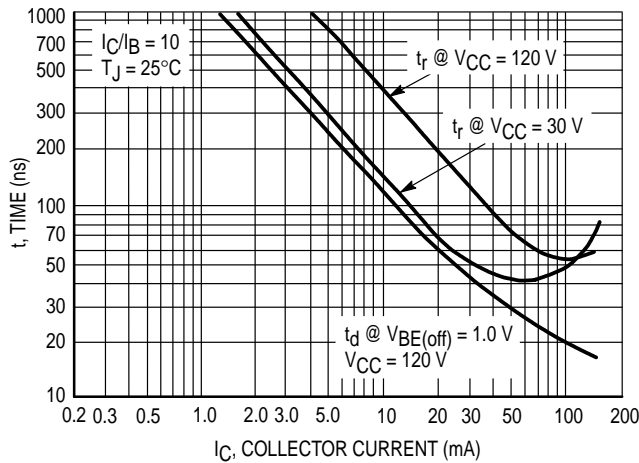

Figure 8. Turn-On Time

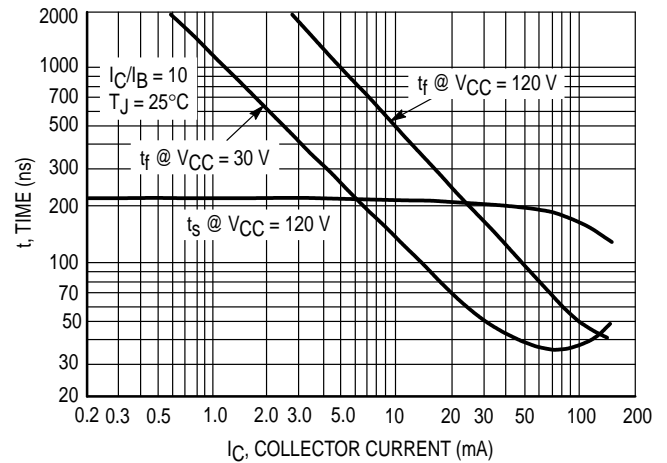
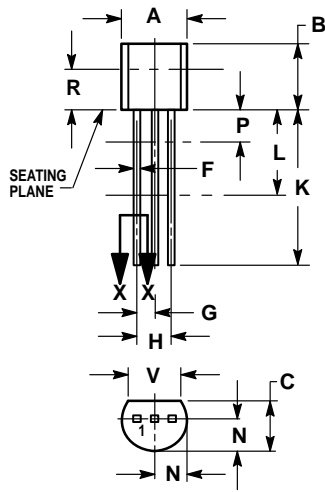

Figure 9. Turn-Off Time

PACKAGE DIMENSIONS



**CASE 029-04  
(TO-226AA)  
ISSUE AD**

NOTES:

1. DIMENSIONING AND TOLERANCING PER ANSI Y14.5M, 1982.
2. CONTROLLING DIMENSION: INCH.
3. CONTOUR OF PACKAGE BEYOND DIMENSION R IS UNCONTROLLED.
4. DIMENSION F APPLIES BETWEEN P AND L. DIMENSION D AND J APPLY BETWEEN L AND K. MINIMUM LEAD DIMENSION IS UNCONTROLLED IN P AND BEYOND DIMENSION K MINIMUM.

DIM	INCHES		MILLIMETERS	
	MIN	MAX	MIN	MAX
A	0.175	0.205	4.45	5.20
B	0.170	0.210	4.32	5.33
C	0.125	0.165	3.18	4.19
D	0.016	0.022	0.41	0.55
F	0.016	0.019	0.41	0.48
G	0.045	0.055	1.15	1.39
H	0.095	0.105	2.42	2.66
J	0.015	0.020	0.39	0.50
K	0.500	—	12.70	—
L	0.250	—	6.35	—
N	0.080	0.105	2.04	2.66
P	—	0.100	—	2.54
R	0.115	—	2.93	—
V	0.135	—	3.43	—

STYLE 1:

- PIN 1. EMITTER
2. BASE
3. COLLECTOR

Motorola reserves the right to make changes without further notice to any products herein. Motorola makes no warranty, representation or guarantee regarding the suitability of its products for any particular purpose, nor does Motorola assume any liability arising out of the application or use of any product or circuit, and specifically disclaims any and all liability, including without limitation consequential or incidental damages. "Typical" parameters can and do vary in different applications. All operating parameters, including "Typicals" must be validated for each customer application by customer's technical experts. Motorola does not convey any license under its patent rights nor the rights of others. Motorola products are not designed, intended, or authorized for use as components in systems intended for surgical implant into the body, or other applications intended to support or sustain life, or for any other application in which the failure of the Motorola product could create a situation where personal injury or death may occur. Should Buyer purchase or use Motorola products for any such unintended or unauthorized application, Buyer shall indemnify and hold Motorola and its officers, employees, subsidiaries, affiliates, and distributors harmless against all claims, costs, damages, and expenses, and reasonable attorney fees arising out of, directly or indirectly, any claim of personal injury or death associated with such unintended or unauthorized use, even if such claim alleges that Motorola was negligent regarding the design or manufacture of the part. Motorola and  are registered trademarks of Motorola, Inc. Motorola, Inc. is an Equal Opportunity/Affirmative Action Employer.

**How to reach us:**

**USA/EUROPE:** Motorola Literature Distribution;  
P.O. Box 20912; Phoenix, Arizona 85036. 1-800-441-2447

**JAPAN:** Nippon Motorola Ltd.; Tatsumi-SPD-JLDC, Toshikatsu Otsuki,  
6F Seibu-Butsuryu-Center, 3-14-2 Tatsumi Koto-Ku, Tokyo 135, Japan. 03-3521-8315

**MFAX:** RMFAX0@email.sps.mot.com - TOUCHTONE (602) 244-6609  
**INTERNET:** <http://Design-NET.com>

**HONG KONG:** Motorola Semiconductors H.K. Ltd.; 8B Tai Ping Industrial Park,  
51 Ting Kok Road, Tai Po, N.T., Hong Kong. 852-26629298

