

# Darlington Complementary Silicon Power Transistors

... designed for general-purpose amplifier and low frequency switching applications.

- High DC Current Gain —  
 $h_{FE} = 3500$  (Typ) @  $I_C = 5.0$  Adc
- Collector-Emitter Sustaining Voltage — @ 100 mA  
 $V_{CE(sus)} = 80$  Vdc (Min) — 2N6058  
 100 Vdc (Min) — 2N6052, 2N6059
- Monolithic Construction with Built-In Base-Emitter Shunt Resistors

## MAXIMUM RATINGS (1)

Rating	Symbol	2N6058	2N6052 2N6059	Unit
Collector-Emitter Voltage	$V_{CEO}$	80	100	Vdc
Collector-Base Voltage	$V_{CB}$	80	100	Vdc
Emitter-Base voltage	$V_{EB}$	5.0		Vdc
Collector Current — Continuous Peak	$I_C$	12 20		Adc
Base Current	$I_B$	0.2		Adc
Total Device Dissipation @ $T_C = 25^\circ\text{C}$ Derate above $25^\circ\text{C}$	$P_D$	150 0.857		Watts W/ $^\circ\text{C}$
Operating and Storage Junction Temperature Range	$T_J, T_{stg}$	-65 to +200 $^\circ\text{C}$		$^\circ\text{C}$

## THERMAL CHARACTERISTICS

Characteristic	Symbol	Rating	Unit
Thermal Resistance, Junction to Case	$R_{\theta JC}$	1.17	$^\circ\text{C}/\text{W}$

(1) Indicates JEDEC Registered Data.

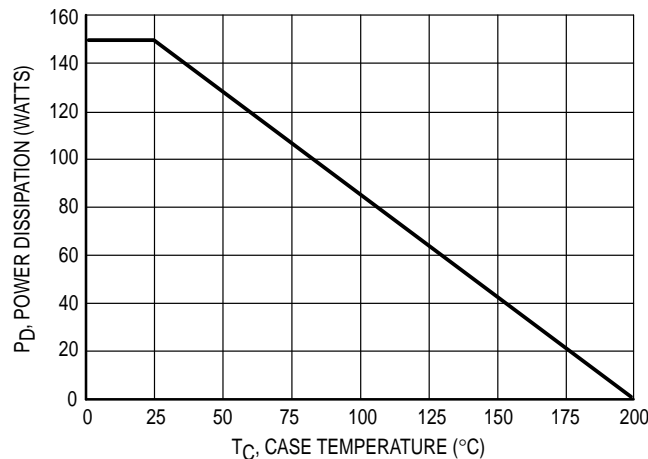

Figure 1. Power Derating

Preferred devices are Motorola recommended choices for future use and best overall value.

**PNP**  
**2N6052\***

**NPN**  
**2N6058**  
**2N6059\***

\*Motorola Preferred Device

**DARLINGTON**  
**12 AMPERE**  
**COMPLEMENTARY**  
**SILICON**  
**POWER TRANSISTORS**  
**80-100 VOLTS**  
**150 WATTS**

**CASE 1-07**  
**TO-204AA**  
**(TO-3)**

# 2N6052

\*ELECTRICAL CHARACTERISTICS ( $T_C = 25^\circ\text{C}$  unless otherwise noted)

Characteristic	Symbol	Min	Max	Unit
<b>OFF CHARACTERISTICS</b>				
Collector–Emitter Sustaining Voltage (1) ( $I_C = 100\text{ mAdc}$ , $I_B = 0$ )	$V_{CE(sus)}$	80 100	— —	Vdc
Collector Cutoff Current ( $V_{CE} = 40\text{ Vdc}$ , $I_B = 0$ ) ( $V_{CE} = 50\text{ Vdc}$ , $I_B = 0$ )	$I_{CEO}$	— —	1.0 1.0	mAdc
Collector Cutoff Current ( $V_{CE} = \text{Rated } V_{CE0}$ , $V_{BE(off)} = 1.5\text{ Vdc}$ ) ( $V_{CE} = \text{Rated } V_{CE0}$ , $V_{BE(off)} = 1.5\text{ Vdc}$ , $T_C = 150^\circ\text{C}$ )	$I_{CEX}$	—	0.5 5.0	mAdc
Emitter Cutoff Current ( $V_{BE} = 5.0\text{ Vdc}$ , $I_C = 0$ )	$I_{EBO}$	—	2.0	mAdc

<b>ON CHARACTERISTICS (1)</b>				
DC Current Gain ( $I_C = 6.0\text{ Adc}$ , $V_{CE} = 3.0\text{ Vdc}$ ) ( $I_C = 12\text{ Adc}$ , $V_{CE} = 3.0\text{ Vdc}$ )	$h_{FE}$	750 100	18,000 —	—
Collector–Emitter Saturation Voltage ( $I_C = 6.0\text{ Adc}$ , $I_B = 24\text{ mAdc}$ ) ( $I_C = 12\text{ Adc}$ , $I_B = 120\text{ mAdc}$ )	$V_{CE(sat)}$	— —	2.0 3.0	Vdc
Base–Emitter Saturation Voltage ( $I_C = 12\text{ Adc}$ , $I_B = 120\text{ mAdc}$ )	$V_{BE(sat)}$	—	4.0	Vdc
Base–Emitter On Voltage ( $I_C = 6.0\text{ Adc}$ , $V_{CE} = 3.0\text{ Vdc}$ )	$V_{BE(on)}$	—	2.8	Vdc

<b>DYNAMIC CHARACTERISTICS</b>				
Magnitude of Common Emitter Small–Signal Short Circuit Forward Current Transfer Ratio ( $I_C = 5.0\text{ Adc}$ , $V_{CE} = 3.0\text{ Vdc}$ , $f = 1.0\text{ MHz}$ )	$ h_{fe} $	4.0	—	MHz
Output Capacitance ( $V_{CB} = 10\text{ Vdc}$ , $I_E = 0$ , $f = 0.1\text{ MHz}$ )	$C_{ob}$	— —	500 300	pF
Small–Signal Current Gain ( $I_C = 5.0\text{ Adc}$ , $V_{CE} = 3.0\text{ Vdc}$ , $f = 1.0\text{ kHz}$ )	$h_{fe}$	300	—	—

\* Indicates JEDEC Registered Data.

(1) Pulse test: Pulse Width = 300  $\mu\text{s}$ , Duty Cycle = 2.0%.

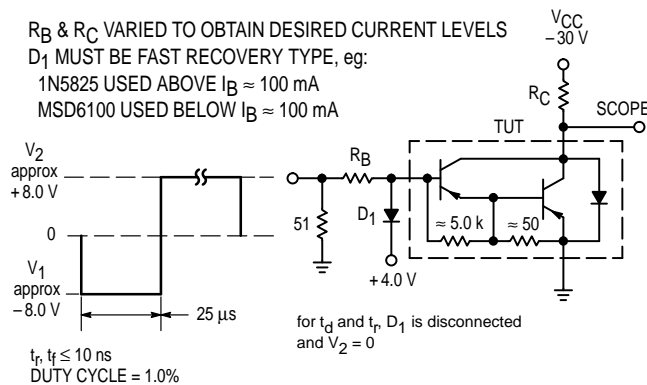

For NPN test circuit reverse diode and voltage polarities.

Figure 2. Switching Times Test Circuit

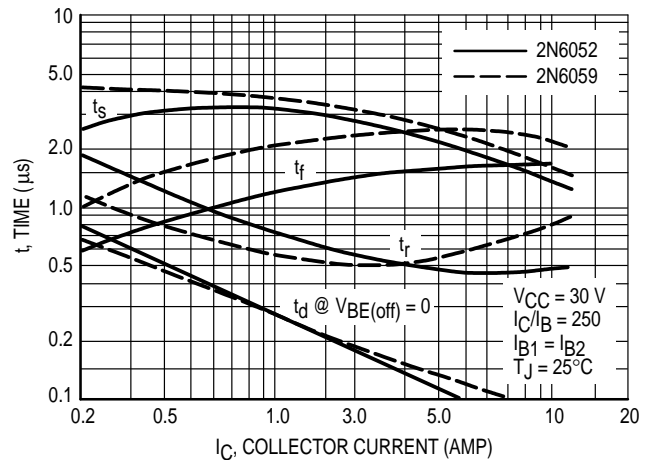

Figure 3. Switching Times

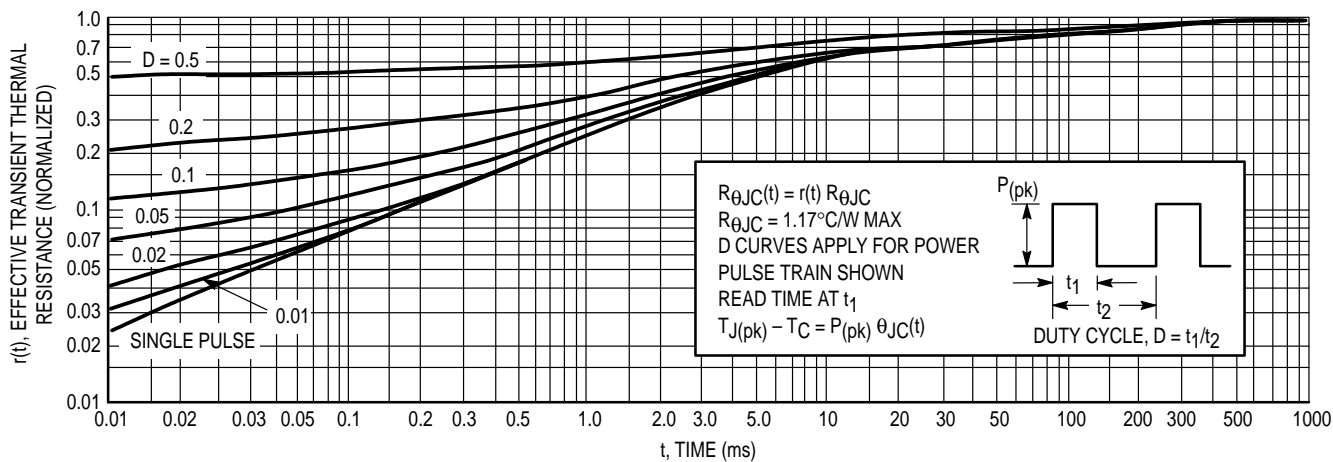

Figure 4. Thermal Response

ACTIVE-REGION SAFE OPERATING AREA

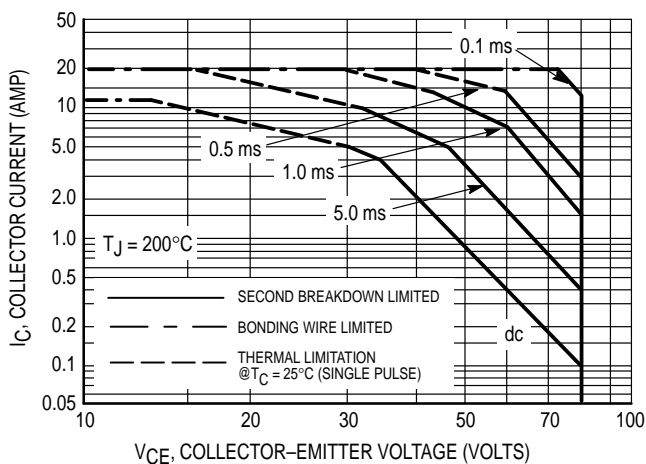

Figure 5. 2N6058

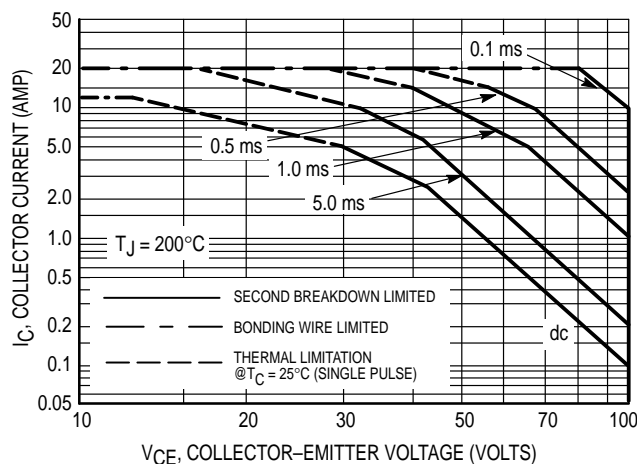

Figure 6. 2N6052, 2N6059

There are two limitations on the power handling ability of a transistor: average junction temperature and second breakdown. Safe operating area curves indicate  $I_C - V_{CE}$  limits of the transistor that must be observed for reliable operation; i.e., the transistor must not be subjected to greater dissipation than the curves indicate.

The data of Figures 5, 6 and 7 is based on  $T_{J(pk)} = 200^\circ\text{C}$ ;  $T_c$  is variable depending on conditions. Second breakdown pulse limits are valid for duty cycles to 10% provided  $T_{J(pk)} \leq 200^\circ\text{C}$ ;  $T_{J(pk)}$  may be calculated from the data in Figure 4. At high case temperatures, thermal limitations will reduce the power that can be handled to values less than the limitations imposed by second breakdown.

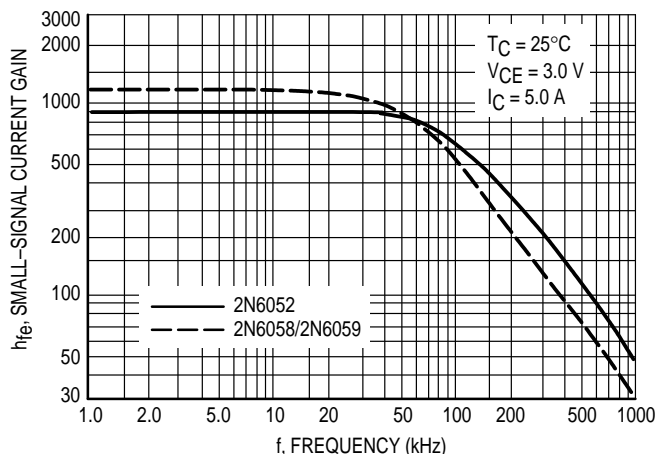

Figure 7. Small-Signal Current Gain

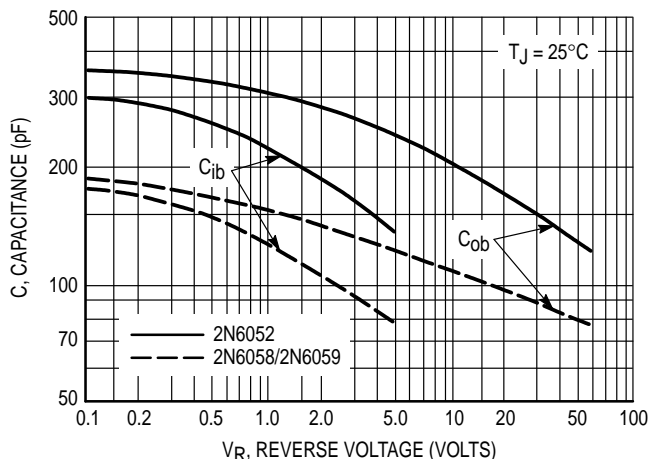

Figure 8. Capacitance

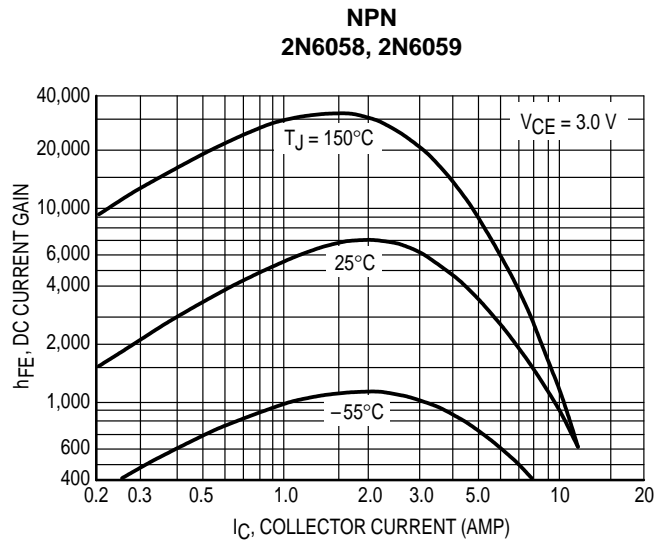
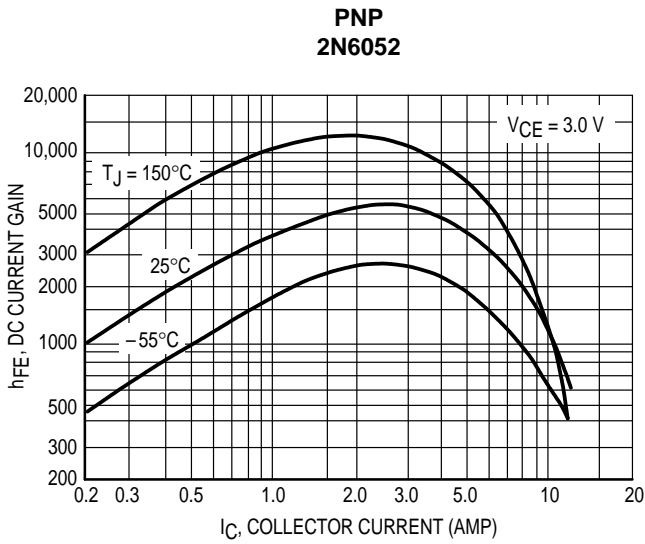

Figure 9. DC Current Gain

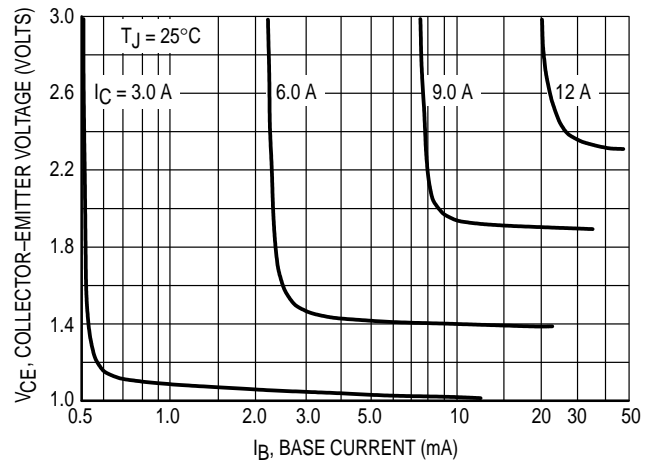
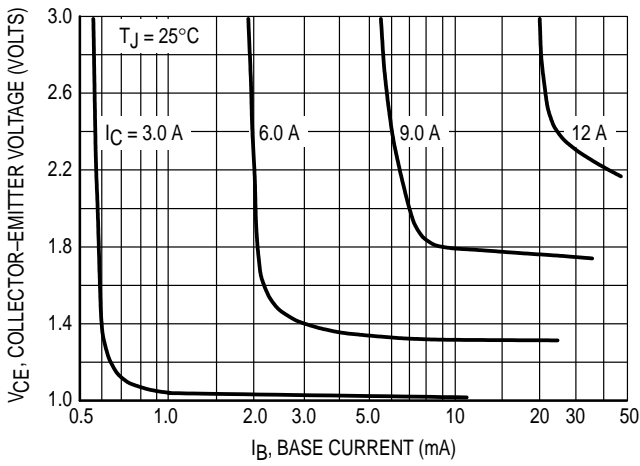

Figure 10. Collector Saturation Region

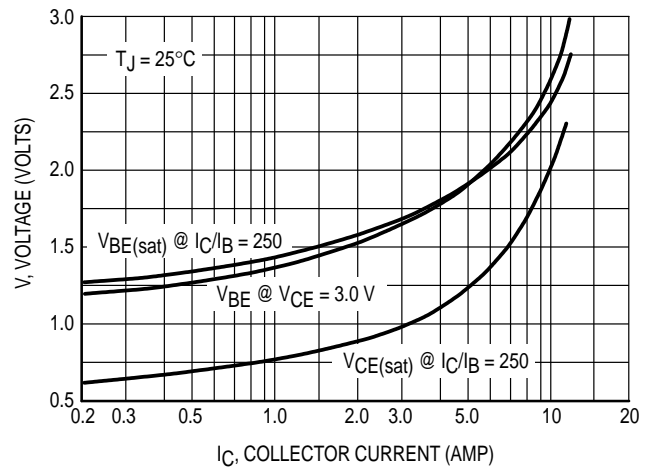
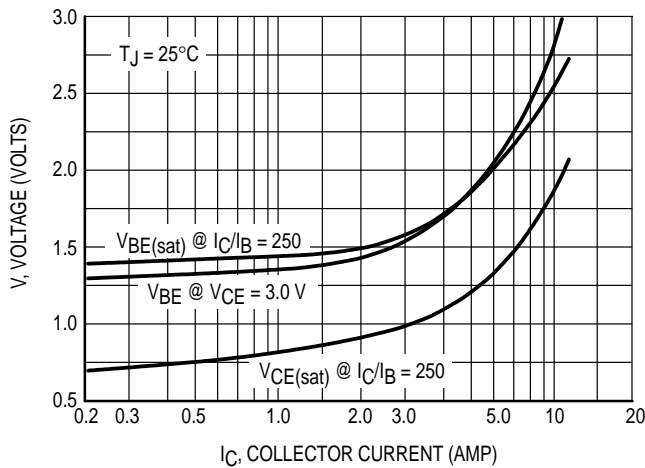
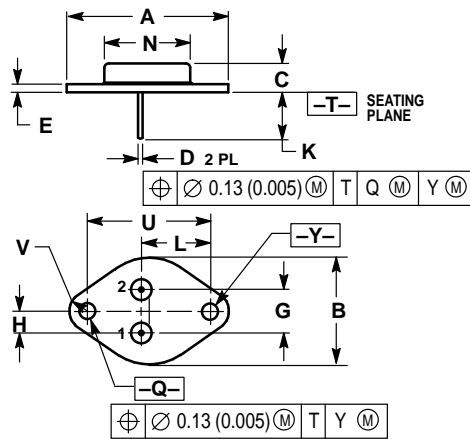

Figure 11. "On" Voltages

PACKAGE DIMENSIONS



- NOTES:  
 1. DIMENSIONING AND TOLERANCING PER ANSI Y14.5M, 1982.  
 2. CONTROLLING DIMENSION: INCH.  
 3. ALL RULES AND NOTES ASSOCIATED WITH REFERENCED TO-204AA OUTLINE SHALL APPLY.

DIM	INCHES		MILLIMETERS	
	MIN	MAX	MIN	MAX
A	1.550 REF		39.37 REF	
B	—	1.050	—	26.67
C	0.250	0.335	6.35	8.51
D	0.038	0.043	0.97	1.09
E	0.055	0.070	1.40	1.77
G	0.430 BSC		10.92 BSC	
H	0.215 BSC		5.46 BSC	
K	0.440	0.480	11.18	12.19
L	0.665 BSC		16.89 BSC	
N	—	0.830	—	21.08
Q	0.151	0.165	3.84	4.19
U	1.187 BSC		30.15 BSC	
V	0.131	0.188	3.33	4.77

STYLE 1:  
 PIN 1. BASE  
 2. EMITTER  
 CASE: COLLECTOR

CASE 1-07  
 TO-204AA (TO-3)  
 ISSUE Z

Motorola reserves the right to make changes without further notice to any products herein. Motorola makes no warranty, representation or guarantee regarding the suitability of its products for any particular purpose, nor does Motorola assume any liability arising out of the application or use of any product or circuit, and specifically disclaims any and all liability, including without limitation consequential or incidental damages. "Typical" parameters which may be provided in Motorola data sheets and/or specifications can and do vary in different applications and actual performance may vary over time. All operating parameters, including "Typicals" must be validated for each customer application by customer's technical experts. Motorola does not convey any license under its patent rights nor the rights of others. Motorola products are not designed, intended, or authorized for use as components in systems intended for surgical implant into the body, or other applications intended to support or sustain life, or for any other application in which the failure of the Motorola product could create a situation where personal injury or death may occur. Should Buyer purchase or use Motorola products for any such unintended or unauthorized application, Buyer shall indemnify and hold Motorola and its officers, employees, subsidiaries, affiliates, and distributors harmless against all claims, costs, damages, and expenses, and reasonable attorney fees arising out of, directly or indirectly, any claim of personal injury or death associated with such unintended or unauthorized use, even if such claim alleges that Motorola was negligent regarding the design or manufacture of the part. Motorola and  are registered trademarks of Motorola, Inc. Motorola, Inc. is an Equal Opportunity/Affirmative Action Employer.

Mfax is a trademark of Motorola, Inc.

**How to reach us:**

**USA/EUROPE/Locations Not Listed:** Motorola Literature Distribution;  
P.O. Box 5405, Denver, Colorado 80217. 1-303-675-2140 or 1-800-441-2447

**JAPAN:** Nippon Motorola Ltd.; SPD, Strategic Planning Office, 141,  
4-32-1 Nishi-Gotanda, Shinagawa-ku, Tokyo, Japan. 81-3-5487-8488

**Customer Focus Center: 1-800-521-6274**

**Mfax™:** RMFAX0@email.sps.mot.com – TOUCHTONE 1-602-244-6609  
Motorola Fax Back System – US & Canada ONLY 1-800-774-1848  
– http://sps.motorola.com/mfax/

**ASIA/PACIFIC:** Motorola Semiconductors H.K. Ltd.; 8B Tai Ping Industrial Park,  
51 Ting Kok Road, Tai Po, N.T., Hong Kong. 852-26629298

**HOME PAGE:** <http://motorola.com/sps/>



**MOTOROLA**

