

SWITCHMODE™ Series NPN Silicon Power Transistor

... designed for high speed, high current, high power applications.

- High DC current gain:
 $h_{FE} \text{ min} = 20 \text{ at } I_C = 25 \text{ A}$
 $= 10 \text{ at } I_C = 50 \text{ A}$
- Low $V_{CE(sat)}$:
 $V_{CE(sat)} \text{ max.} = 0.6 \text{ V at } I_C = 25 \text{ A}$
 $= 0.9 \text{ V at } I_C = 50 \text{ A}$
- Very fast switching times:
 $T_F = 0.25 \mu\text{s at } I_C = 50 \text{ A}$

MAXIMUM RATINGS

Rating	Symbol	BUV20	BUV60	Unit
Collector–Emitter Voltage	$V_{CEO(sus)}$	125		Vdc
Collector–Base Voltage	V_{CBO}	160	260	Vdc
Emitter–Base Voltage	V_{EBO}	7		Vdc
Collector–Emitter Voltage ($V_{BE} = -1.5 \text{ V}$)	V_{CEX}	160	260	Vdc
Collector–Emitter voltage ($R_{BE} = 100 \Omega$)	V_{CER}	150	260	Vdc
Collector–Current — Continuous — Peak ($PW \leq 10 \text{ ms}$)	I_C	50		Adc
	I_{CM}	60		Apk
Base–Current continuous	I_B	10		Adc
Total Power Dissipation @ $T_C = 25^\circ\text{C}$	P_D	250		Watts
Operating and Storage Junction Temperature Range	T_J, T_{stg}	–65 to 200		$^\circ\text{C}$

THERMAL CHARACTERISTICS

Characteristic	Symbol	BUV20	BUV60	Unit
Thermal Resistance, Junction to Case	θ_{JC}	0.7		$^\circ\text{C/W}$

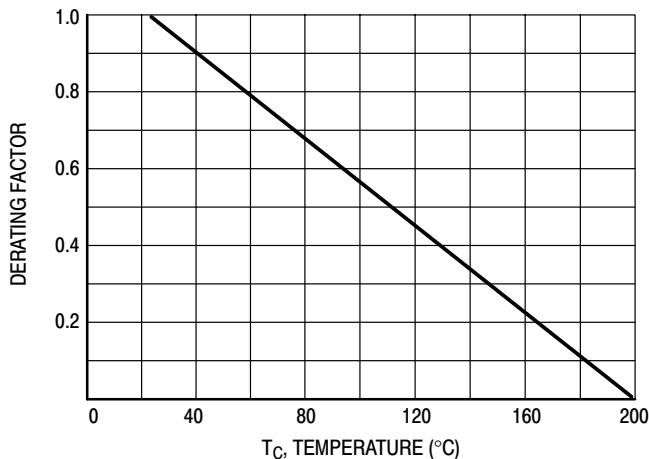
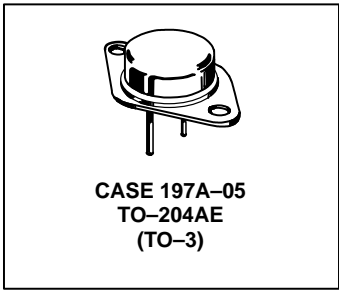

Figure 1. Power Derating

BUV20
BUV60

50 AMPERES
NPN SILICON
POWER
METAL TRANSISTOR
125 VOLTS
250 WATTS



BUV20 BUV60

ELECTRICAL CHARACTERISTICS ($T_C = 25^\circ\text{C}$ unless otherwise noted)

Characteristic	Symbol	Min	Max	Unit
OFF CHARACTERISTICS¹				
Collector–Emitter Sustaining Voltage ($I_C = 200\text{ mA}$, $I_B = 0$, $L = 25\text{ mH}$)	BUV20, BUV60 $V_{CEO(sus)}$	125		Vdc
Collector Cutoff Current at Reverse Bias ($V_{CE} = 140\text{ V}$, $V_{BE} = -1.5\text{ V}$) ($V_{CE} = 140\text{ V}$, $V_{BE} = -1.5\text{ V}$, $T_C = 125^\circ\text{C}$) ($V_{CE} = 260\text{ V}$, $V_{BE} = -1.5\text{ V}$)	BUV20 BUV20 BUV60 I_{CEX}		3.0 12	mAdc
Collector–Emitter Cutoff Current ($V_{CE} = 100\text{ V}$)	BUV20 I_{CEO}		3.0	mAdc
Emitter–Base Reverse Voltage ($I_E = 50\text{ mA}$)	BUV20, BUV60 V_{EBO}	7		V
Emitter–Cutoff Current ($V_{EB} = 5\text{ V}$)	BUV20, BUV60 I_{EBO}		1.0	mAdc

SECOND BREAKDOWN

Second Breakdown Collector Current with base forward biased ($V_{CE} = 20\text{ V}$, $t = 1\text{ s}$) ($V_{CE} = 40\text{ V}$, $t = 1\text{ s}$)	$I_{S/b}$	12 1.5		A
---	-----------	-----------	--	---

ON CHARACTERISTICS¹

DC Current Gain ($I_C = 25\text{ A}$, $V_{CE} = 2\text{ V}$) ($I_C = 50\text{ A}$, $V_{CE} = 4\text{ V}$)	BUV20 BUV20 h_{FE}	20 10	60 –	
Collector–Emitter Saturation Voltage ($I_C = 25\text{ A}$, $I_B = 2.5\text{ A}$) ($I_C = 50\text{ A}$, $I_B = 5\text{ A}$)	BUV20 BUV20 $V_{CE(sat)}$		0.6 1.2	Vdc
Base–Emitter Saturation Voltage ($I_C = 50\text{ A}$, $I_B = 5\text{ A}$)	BUV20 $V_{BE(sat)}$		2.0	Vdc
Collector–Emitter Saturation Voltage ($I_C = 25\text{ A}$, $I_B = 1.25\text{ A}$) ($I_C = 50\text{ A}$, $I_B = 5\text{ A}$) ($I_C = 60\text{ A}$, $I_B = 7.5\text{ A}$)	BUV60 BUV60 BUV60 $V_{CE(sat)}$		0.9 0.9 1.2	Vdc
Base–Emitter Saturation Voltage ($I_C = 50\text{ A}$, $I_B = 5\text{ A}$) ($I_C = 60\text{ A}$, $I_B = 7.5\text{ A}$)	BUV60 BUV60 $V_{BE(sat)}$		1.6 1.8	Vdc

DYNAMIC CHARACTERISTICS

Current Gain — Bandwidth Product ($V_{CE} = 15\text{ V}$, $I_C = 2\text{ A}$, $f = 4\text{ MHz}$)	f_T	8.0		MHz
--	-------	-----	--	-----

SWITCHING CHARACTERISTICS (Resistive Load)

Turn-on Time	$(I_C = 50\text{ A}$, $I_{B1} = I_{B2} = 5\text{ A}$, $V_{CC} = 30\text{ V}$, $R_C = 0.6\ \Omega$)	t_{on}	1.5	μs
Storage Time		t_s	1.2	
Fall Time		t_f	0.25	

¹ Pulse Test: Pulse Width $\leq 300\ \mu\text{s}$, Duty Cycle $\leq 2\%$.

BUV20 BUV60

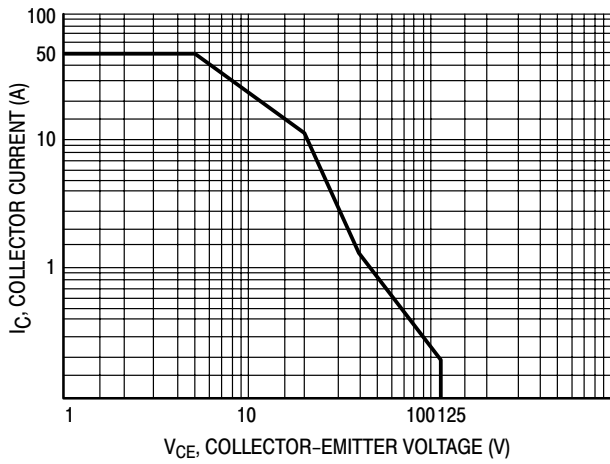

Figure 2. Active Region Safe Operating Area

There are two limitations on the power handling ability of a transistor: average junction temperature and second breakdown. Safe operating area curves indicate $I_C - V_{CE}$ limits of the transistor that must be observed for reliable operation i.e., the transistor must not be subjected to greater dissipation than the curves indicate.

The data of Figure 2 is based on $T_C = 25^\circ\text{C}$. $T_{J(pk)}$ is variable depending on power level. Second breakdown limitations do not derate the same as thermal limitations.

At high case temperatures, thermal limitations will reduce the power that can be handled to values less than the limitations imposed by second breakdown.

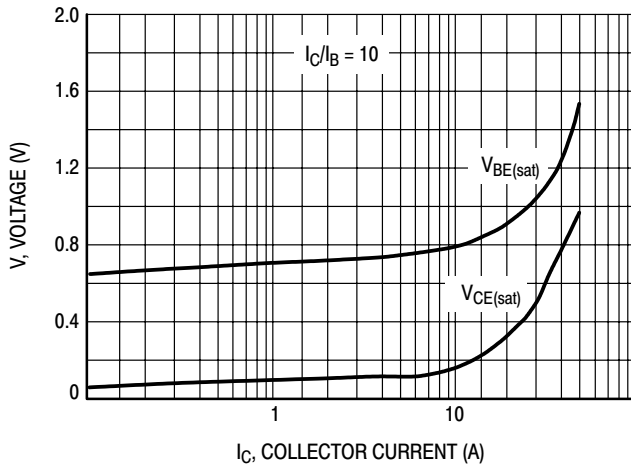

Figure 3. "On" Voltages

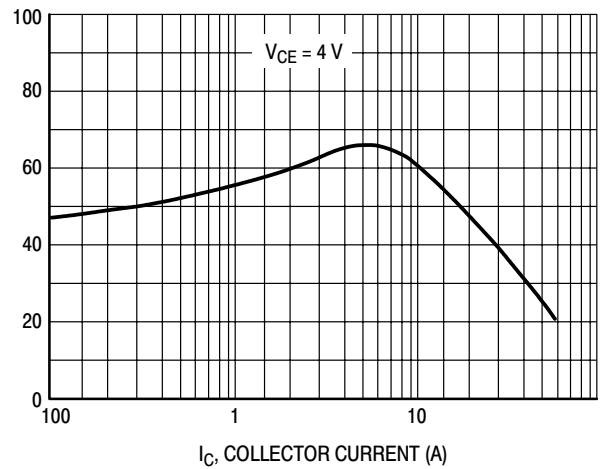

Figure 4. DC Current Gain

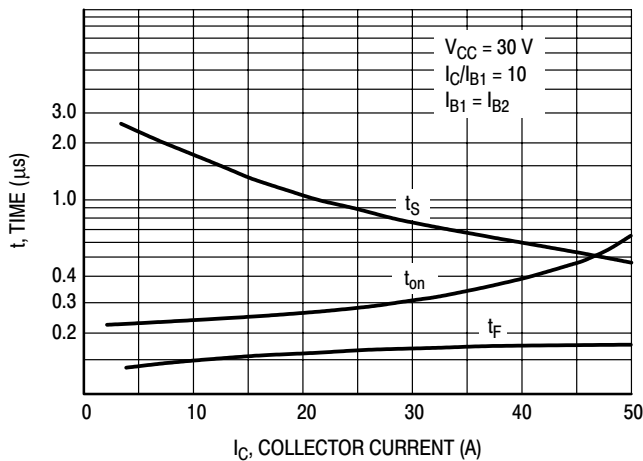

Figure 5. Resistive Switching Performance

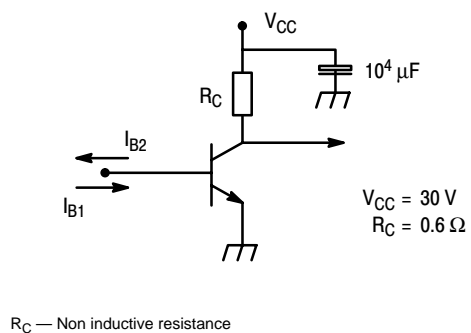
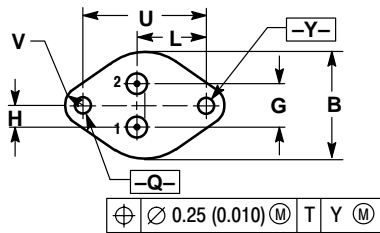
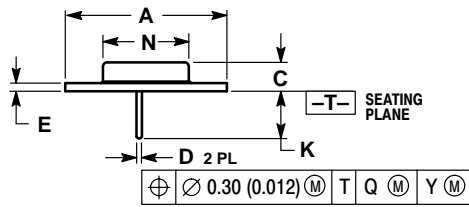

Figure 6. Switching Times Test Circuit

BUV20 BUV60

PACKAGE DIMENSIONS

TO-204AE (TO-3)
CASE 197A-05
ISSUE J



- NOTES:
1. DIMENSIONING AND TOLERANCING PER ANSI Y14.5M, 1982.
2. CONTROLLING DIMENSION: INCH.

DIM	INCHES		MILLIMETERS	
	MIN	MAX	MIN	MAX
A	1.530 REF		38.86 REF	
B	0.990	1.050	25.15	26.67
C	0.250	0.335	6.35	8.51
D	0.057	0.063	1.45	1.60
E	0.060	0.070	1.53	1.77
G	0.430 BSC		10.92 BSC	
H	0.215 BSC		5.46 BSC	
K	0.440	0.480	11.18	12.19
L	0.665 BSC		16.89 BSC	
N	0.760	0.830	19.31	21.08
Q	0.151	0.165	3.84	4.19
U	1.187 BSC		30.15 BSC	
V	0.131	0.188	3.33	4.77

SWITCHMODE is a trademark of Semiconductor Components Industries, LLC (SCILLC)

ON Semiconductor and  are trademarks of Semiconductor Components Industries, LLC (SCILLC). SCILLC reserves the right to make changes without further notice to any products herein. SCILLC makes no warranty, representation or guarantee regarding the suitability of its products for any particular purpose, nor does SCILLC assume any liability arising out of the application or use of any product or circuit, and specifically disclaims any and all liability, including without limitation special, consequential or incidental damages. "Typical" parameters which may be provided in SCILLC data sheets and/or specifications can and do vary in different applications and actual performance may vary over time. All operating parameters, including "Typicals" must be validated for each customer application by customer's technical experts. SCILLC does not convey any license under its patent rights nor the rights of others. SCILLC products are not designed, intended, or authorized for use as components in systems intended for surgical implant into the body, or other applications intended to support or sustain life, or for any other application in which the failure of the SCILLC product could create a situation where personal injury or death may occur. Should Buyer purchase or use SCILLC products for any such unintended or unauthorized application, Buyer shall indemnify and hold SCILLC and its officers, employees, subsidiaries, affiliates, and distributors harmless against all claims, costs, damages, and expenses, and reasonable attorney fees arising out of, directly or indirectly, any claim of personal injury or death associated with such unintended or unauthorized use, even if such claim alleges that SCILLC was negligent regarding the design or manufacture of the part. SCILLC is an Equal Opportunity/Affirmative Action Employer.

PUBLICATION ORDERING INFORMATION

NORTH AMERICA Literature Fulfillment:

Literature Distribution Center for ON Semiconductor
P.O. Box 5163, Denver, Colorado 80217 USA
Phone: 303-675-2175 or 800-344-3860 Toll Free USA/Canada
Fax: 303-675-2176 or 800-344-3867 Toll Free USA/Canada
Email: ONlit@hibbertco.com
Fax Response Line: 303-675-2167 or 800-344-3810 Toll Free USA/Canada

N. American Technical Support: 800-282-9855 Toll Free USA/Canada

EUROPE: LDC for ON Semiconductor – European Support

German Phone: (+1) 303-308-7140 (Mon-Fri 2:30pm to 7:00pm CET)
Email: ONlit-german@hibbertco.com
French Phone: (+1) 303-308-7141 (Mon-Fri 2:00pm to 7:00pm CET)
Email: ONlit-french@hibbertco.com
English Phone: (+1) 303-308-7142 (Mon-Fri 12:00pm to 5:00pm GMT)
Email: ONlit@hibbertco.com

EUROPEAN TOLL-FREE ACCESS*: 00-800-4422-3781

*Available from Germany, France, Italy, UK, Ireland

CENTRAL/SOUTH AMERICA:

Spanish Phone: 303-308-7143 (Mon-Fri 8:00am to 5:00pm MST)
Email: ONlit-spanish@hibbertco.com
Toll-Free from Mexico: Dial 01-800-288-2872 for Access –
then Dial 866-297-9322

ASIA/PACIFIC: LDC for ON Semiconductor – Asia Support

Phone: 1-303-675-2121 (Tue-Fri 9:00am to 1:00pm, Hong Kong Time)
Toll Free from Hong Kong & Singapore:
001-800-4422-3781
Email: ONlit-asia@hibbertco.com

JAPAN: ON Semiconductor, Japan Customer Focus Center

4-32-1 Nishi-Gotanda, Shinagawa-ku, Tokyo, Japan 141-0031
Phone: 81-3-5740-2700
Email: r14525@onsemi.com

ON Semiconductor Website: <http://onsemi.com>

For additional information, please contact your local Sales Representative.