

MC14093B

Quad 2-Input “NAND” Schmitt Trigger

The MC14093B Schmitt trigger is constructed with MOS P-channel and N-channel enhancement mode devices in a single monolithic structure. These devices find primary use where low power dissipation and/or high noise immunity is desired. The MC14093B may be used in place of the MC14011B quad 2-input NAND gate for enhanced noise immunity or to “square up” slowly changing waveforms.

Features

- Supply Voltage Range = 3.0 Vdc to 18 Vdc
- Capable of Driving Two Low-Power TTL Loads or One Low-Power Schottky TTL Load Over the Rated Temperature Range
- Triple Diode Protection on All Inputs
- Pin-for-Pin Compatible with CD4093
- Can be Used to Replace MC14011B
- Independent Schmitt-Trigger at each Input
- Pb-Free Packages are Available*

MAXIMUM RATINGS (Voltages Referenced to V_{SS})

Symbol	Parameter	Value	Unit
V_{DD}	DC Supply Voltage Range	-0.5 to +18.0	V
V_{in}, V_{out}	Input or Output Voltage Range (DC or Transient)	-0.5 to $V_{DD} + 0.5$	V
I_{in}, I_{out}	Input or Output Current (DC or Transient) per Pin	± 10	mA
P_D	Power Dissipation, per Package (Note 1)	500	mW
T_A	Ambient Temperature Range	-55 to +125	°C
T_{stg}	Storage Temperature Range	-65 to +150	°C
T_L	Lead Temperature (8-Second Soldering)	260	°C

Maximum ratings are those values beyond which device damage can occur. Maximum ratings applied to the device are individual stress limit values (not normal operating conditions) and are not valid simultaneously. If these limits are exceeded, device functional operation is not implied, damage may occur and reliability may be affected.

1. Temperature Derating:

Plastic “P and D/DW” Packages: - 7.0 mW/°C From 65°C To 125°C

This device contains protection circuitry to guard against damage due to high static voltages or electric fields. However, precautions must be taken to avoid applications of any voltage higher than maximum rated voltages to this high-impedance circuit. For proper operation, V_{in} and V_{out} should be constrained to the range $V_{SS} \leq (V_{in} \text{ or } V_{out}) \leq V_{DD}$.

Unused inputs must always be tied to an appropriate logic voltage level (e.g., either V_{SS} or V_{DD}). Unused outputs must be left open.

*For additional information on our Pb-Free strategy and soldering details, please download the ON Semiconductor Soldering and Mounting Techniques Reference Manual, SOLDERRM/D.



ON Semiconductor®

<http://onsemi.com>

MARKING DIAGRAMS

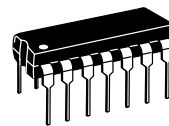

PDP-14
P SUFFIX
CASE 646

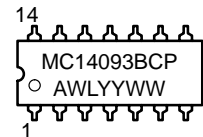

SOIC-14
D SUFFIX
CASE 751A

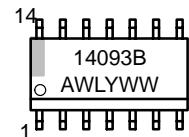

TSSOP-14
DT SUFFIX
CASE 948G

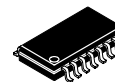
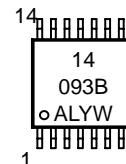

SOEIAJ-14
F SUFFIX
CASE 965

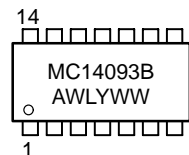

A = Assembly Location
WL, L = Wafer Lot
YY, Y = Year
WW, W = Work Week

ORDERING INFORMATION

See detailed ordering and shipping information in the package dimensions section on page 2 of this data sheet.

MC14093B

PIN ASSIGNMENT

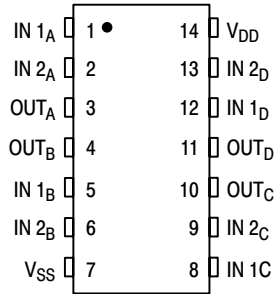

LOGIC DIAGRAM

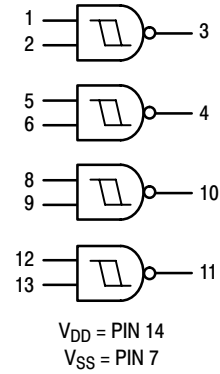

EQUIVALENT CIRCUIT SCHEMATIC (1/4 OF CIRCUIT SHOWN)

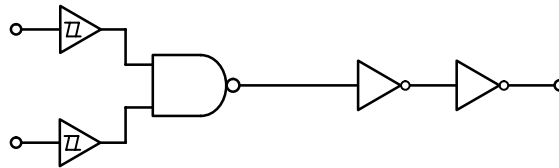

ORDERING INFORMATION

Device	Package	Shipping†
MC14093BCP	PDIP-14	500 Units / Rail
MC14093BCPG	PDIP-14 (Pb-Free)	500 Units / Rail
MC14093BD	SOIC-14	55 Units / Rail
MC14093BDG	SOIC-14 (Pb-Free)	55 Units / Rail
MC14093BDR2	SOIC-14	2500 Units / Tape & Reel
MC14093BDR2G	SOIC-14 (Pb-Free)	2500 Units / Tape & Reel
MC14093BDTR2	TSSOP-14*	2500 Units / Tape & Reel
MC14093BFEL	SOEIAJ-14	2000 Units / Tape & Reel

†For information on tape and reel specifications, including part orientation and tape sizes, please refer to our Tape and Reel Packaging Specifications Brochure, BRD8011/D.

*This package is inherently Pb-Free.

MC14093B

ELECTRICAL CHARACTERISTICS (Voltages Referenced to V_{SS})

Characteristic	Symbol	V_{DD} Vdc	- 55°C		25°C			125°C		Unit
			Min	Max	Min	Typ (2)	Max	Min	Max	
Output Voltage $V_{in} = V_{DD}$ or 0 $V_{in} = 0$ or V_{DD}	"0" Level V_{OL}	5.0	-	0.05	-	0	0.05	-	0.05	Vdc
		10	-	0.05	-	0	0.05	-	0.05	
		15	-	0.05	-	0	0.05	-	0.05	
	"1" Level V_{OH}	5.0	4.95	-	4.95	5.0	-	4.95	-	Vdc
		10	9.95	-	9.95	10	-	9.95	-	
		15	14.95	-	14.95	15	-	14.95	-	
Output Drive Current ($V_{OH} = 2.5$ Vdc) ($V_{OH} = 4.6$ Vdc) ($V_{OH} = 9.5$ Vdc) ($V_{OH} = 13.5$ Vdc) ($V_{OL} = 0.4$ Vdc) ($V_{OL} = 0.5$ Vdc) ($V_{OL} = 1.5$ Vdc)	Source I_{OH}	5.0	-3.0	-	-2.4	-4.2	-	-1.7	-	mAdc
		5.0	-0.64	-	-0.51	-0.88	-	-0.36	-	
		10	-1.6	-	-1.3	-2.25	-	-0.9	-	
		15	-4.2	-	-3.4	-8.8	-	-2.4	-	
	Sink I_{OL}	5.0	0.64	-	0.51	0.88	-	0.36	-	mAdc
		10	1.6	-	1.3	2.25	-	0.9	-	
15		4.2	-	3.4	8.8	-	2.4	-		
Input Current	I_{in}	15	-	± 0.1	-	± 0.00001	± 0.1	-	± 1.0	μ Adc
Input Capacitance ($V_{in} = 0$)	C_{in}	-	-	-	-	5.0	7.5	-	-	pF
Quiescent Current (Per Package)	I_{DD}	5.0	-	0.25	-	0.0005	0.25	-	7.5	μ Adc
		10	-	0.5	-	0.0010	0.5	-	15	
		15	-	1.0	-	0.0015	1.0	-	30	
Total Supply Current (3) (4) (Dynamic plus Quiescent, Per Package) ($C_L = 50$ pF on all outputs, all buffers switching)	I_T	5.0	$I_T = (1.2 \mu A/kHz) f + I_{DD}$							μ Adc
		10	$I_T = (2.4 \mu A/kHz) f + I_{DD}$							
		15	$I_T = (3.6 \mu A/kHz) f + I_{DD}$							
Hysteresis Voltage	$V_{H\uparrow}$	5.0	0.3	2.0	0.3	1.1	2.0	0.3	2.0	Vdc
		10	1.2	3.4	1.2	1.7	3.4	1.2	3.4	
		15	1.6	5.0	1.6	2.1	5.0	1.6	5.0	
Threshold Voltage Positive-Going Negative-Going	V_{T+}	5.0	2.2	3.6	2.2	2.9	3.6	2.2	3.6	Vdc
		10	4.6	7.1	4.6	5.9	7.1	4.6	7.1	
		15	6.8	10.8	6.8	8.8	10.8	6.8	10.8	
	V_{T-}	5.0	0.9	2.8	0.9	1.9	2.8	0.9	2.8	Vdc
		10	2.5	5.2	2.5	3.9	5.2	2.5	5.2	
		15	4.0	7.4	4.0	5.8	7.4	4.0	7.4	

2. Data labelled "Typ" is not to be used for design purposes but is intended as an indication of the IC's potential performance.

3. The formulas given are for the typical characteristics only at 25°C.

4. To calculate total supply current at loads other than 50 pF:

$$I_T(C_L) = I_T(50 \text{ pF}) + (C_L - 50) Vfk$$

where: I_T is in μA (per package), C_L in pF, $V = (V_{DD} - V_{SS})$ in volts, f in kHz is input frequency, and $k = 0.004$.

MC14093B

SWITCHING CHARACTERISTICS ($C_L = 50 \text{ pF}$, $T_A = 25^\circ\text{C}$)

Characteristic	Symbol	V_{DD} Vdc	Min	Typ (5)	Max	Unit
Output Rise Time	t_{TLH}	5.0	–	100	200	ns
		10	–	50	100	
		15	–	40	80	
Output Fall Time	t_{THL}	5.0	–	100	200	ns
		10	–	50	100	
		15	–	40	80	
Propagation Delay Time	t_{PLH} , t_{PHL}	5.0	–	125	250	ns
		10	–	50	100	
		15	–	40	80	

5. Data labeled "Typ" is not to be used for design purposes but is intended as an indication of the IC's potential performance.

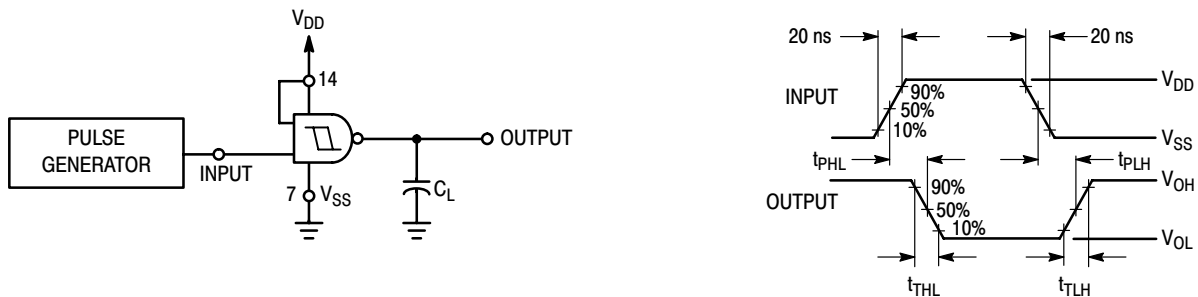

Figure 1. Switching Time Test Circuit and Waveforms

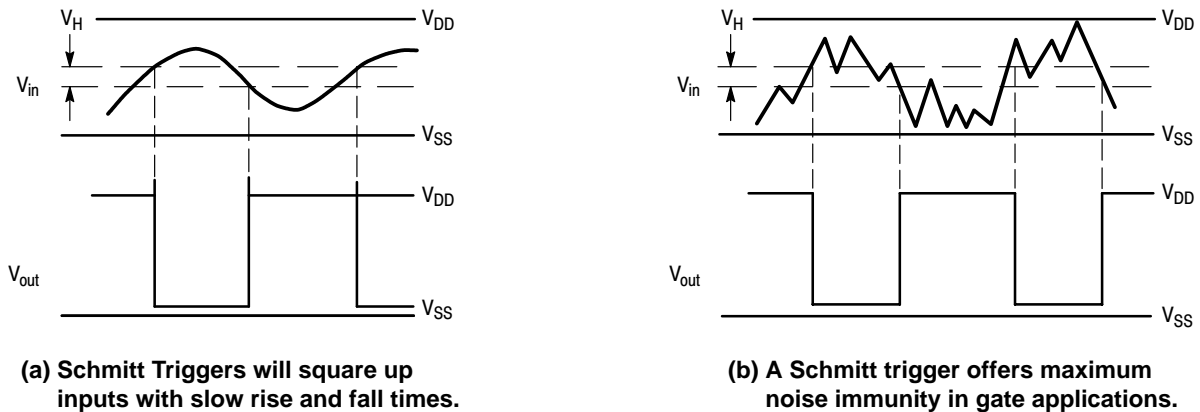

Figure 2. Typical Schmitt Trigger Applications

MC14093B

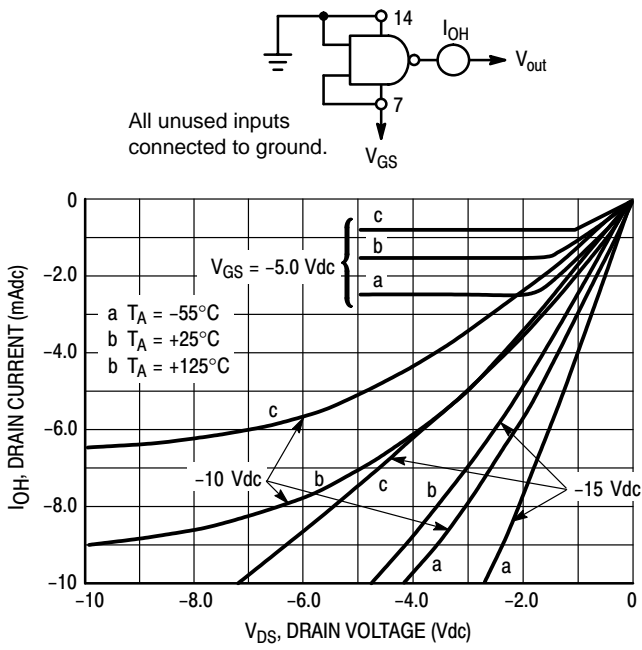

Figure 3. Typical Output Source Characteristics Test Circuit

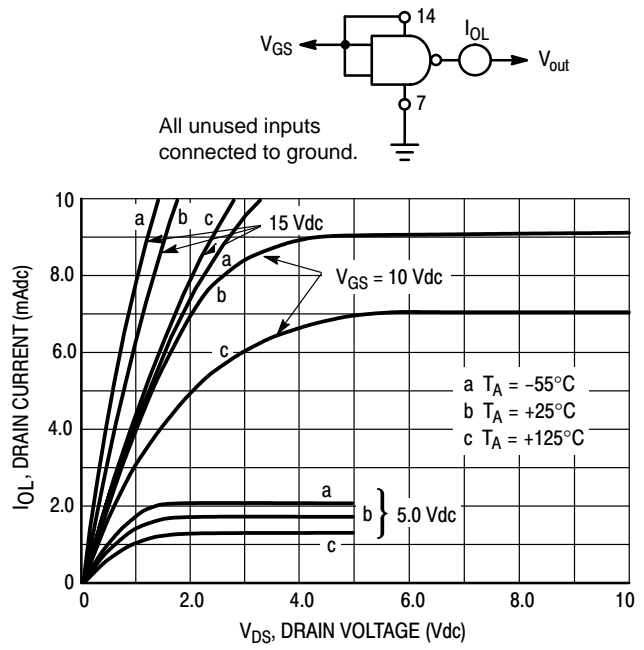

Figure 4. Typical Output Sink Characteristics Test Circuit

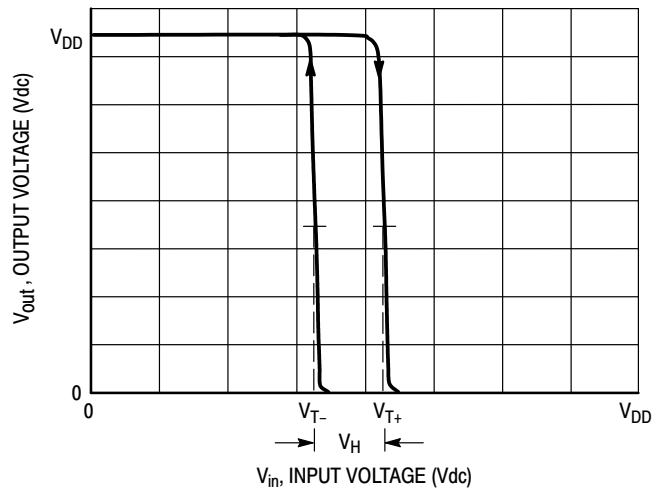
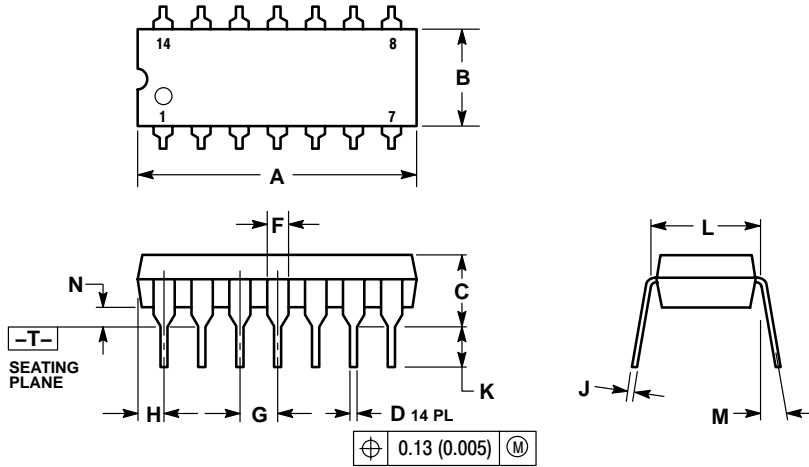

Figure 5. Typical Transfer Characteristics

MC14093B

PACKAGE DIMENSIONS

PDIP-14
P SUFFIX
CASE 646-06
ISSUE N



NOTES:

1. DIMENSIONING AND TOLERANCING PER ANSI Y14.5M, 1982.
2. CONTROLLING DIMENSION: INCH.
3. DIMENSION L TO CENTER OF LEADS WHEN FORMED PARALLEL.
4. DIMENSION B DOES NOT INCLUDE MOLD FLASH.
5. ROUNDED CORNERS OPTIONAL.

DIM	INCHES		MILLIMETERS	
	MIN	MAX	MIN	MAX
A	0.715	0.770	18.16	18.80
B	0.240	0.260	6.10	6.60
C	0.145	0.185	3.69	4.69
D	0.015	0.021	0.38	0.53
F	0.040	0.070	1.02	1.78
G	0.100 BSC		2.54 BSC	
H	0.052	0.095	1.32	2.41
J	0.008	0.015	0.20	0.38
K	0.115	0.135	2.92	3.43
L	0.290	0.310	7.37	7.87
M	10°		10°	
N	0.015	0.039	0.38	1.01

SOIC-14
D SUFFIX
CASE 751A-03
ISSUE G

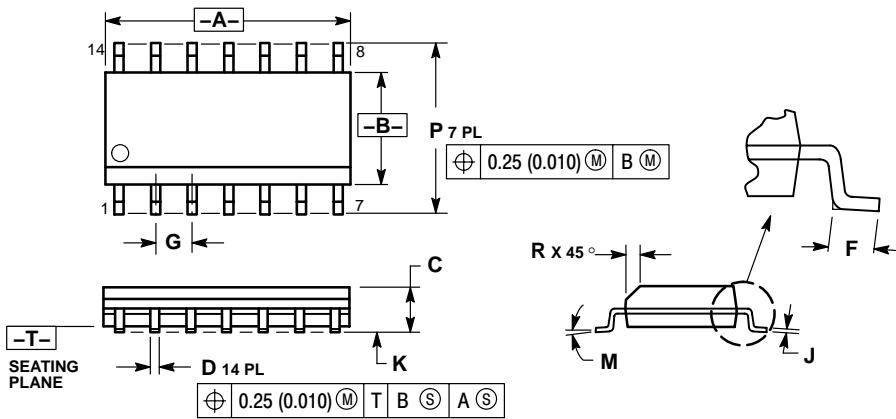

NOTES:

1. DIMENSIONING AND TOLERANCING PER ANSI Y14.5M, 1982.
2. CONTROLLING DIMENSION: MILLIMETER.
3. DIMENSIONS A AND B DO NOT INCLUDE MOLD PROTRUSION.
4. MAXIMUM MOLD PROTRUSION 0.15 (0.006) PER SIDE.
5. DIMENSION D DOES NOT INCLUDE DAMBAR PROTRUSION. ALLOWABLE DAMBAR PROTRUSION SHALL BE 0.127 (0.005) TOTAL IN EXCESS OF THE D DIMENSION AT MAXIMUM MATERIAL CONDITION.

DIM	MILLIMETERS		INCHES	
	MIN	MAX	MIN	MAX
A	8.55	8.75	0.337	0.344
B	3.80	4.00	0.150	0.157
C	1.35	1.75	0.054	0.068
D	0.35	0.49	0.014	0.019
F	0.40	1.25	0.016	0.049
G	1.27 BSC		0.050 BSC	
J	0.19	0.25	0.008	0.009
K	0.10	0.25	0.004	0.009
M	0° 7°		0° 7°	
P	5.80	6.20	0.228	0.244
R	0.25	0.50	0.010	0.019

MC14093B

PACKAGE DIMENSIONS

TSSOP-14
DT SUFFIX
CASE 948G-01
ISSUE O

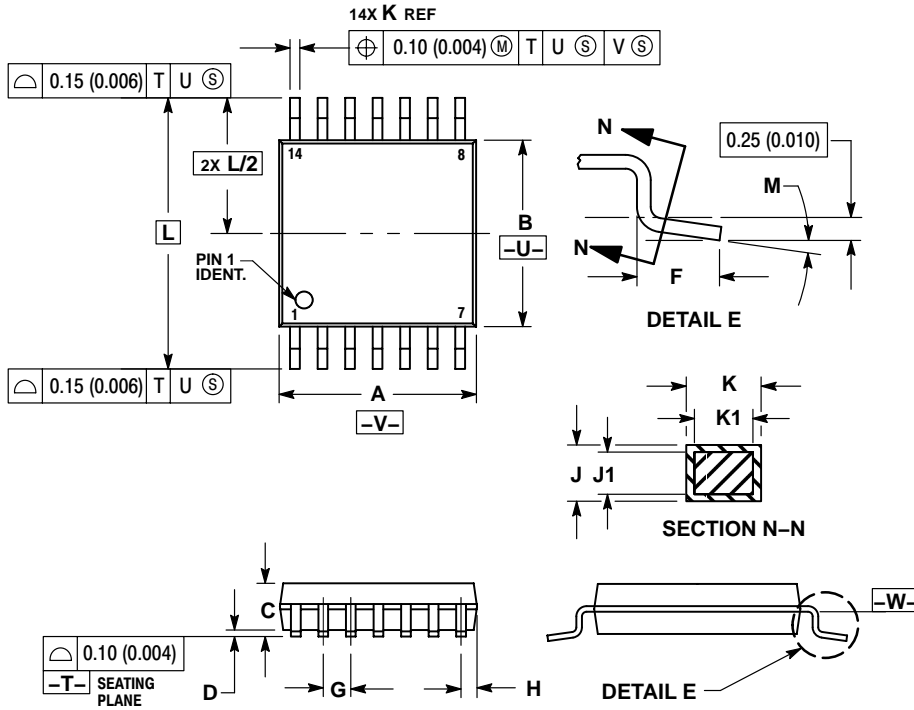

NOTES:

1. DIMENSIONING AND TOLERANCING PER ANSI Y14.5M, 1982.
2. CONTROLLING DIMENSION: MILLIMETER.
3. DIMENSION A DOES NOT INCLUDE MOLD FLASH, PROTRUSIONS OR GATE BURRS. MOLD FLASH OR GATE BURRS SHALL NOT EXCEED 0.15 (0.006) PER SIDE.
4. DIMENSION B DOES NOT INCLUDE INTERLEAD FLASH OR PROTRUSION. INTERLEAD FLASH OR PROTRUSION SHALL NOT EXCEED 0.25 (0.010) PER SIDE.
5. DIMENSION K DOES NOT INCLUDE DAMBAR PROTRUSION. ALLOWABLE DAMBAR PROTRUSION SHALL BE 0.08 (0.003) TOTAL IN EXCESS OF THE K DIMENSION AT MAXIMUM MATERIAL CONDITION.
6. TERMINAL NUMBERS ARE SHOWN FOR REFERENCE ONLY.
7. DIMENSION A AND B ARE TO BE DETERMINED AT DATUM PLANE -W-.

DIM	MILLIMETERS		INCHES	
	MIN	MAX	MIN	MAX
A	4.90	5.10	0.193	0.200
B	4.30	4.50	0.169	0.177
C	---	1.20	---	0.047
D	0.05	0.15	0.002	0.006
F	0.50	0.75	0.020	0.030
G	0.65 BSC		0.026 BSC	
H	0.50	0.60	0.020	0.024
J	0.09	0.20	0.004	0.008
J1	0.09	0.16	0.004	0.006
K	0.19	0.30	0.007	0.012
K1	0.19	0.25	0.007	0.010
L	6.40 BSC		0.252 BSC	
M	0° 8°		0° 8°	

MC14093B

PACKAGE DIMENSIONS

SOEIAJ-14
F SUFFIX
CASE 965-01
ISSUE O

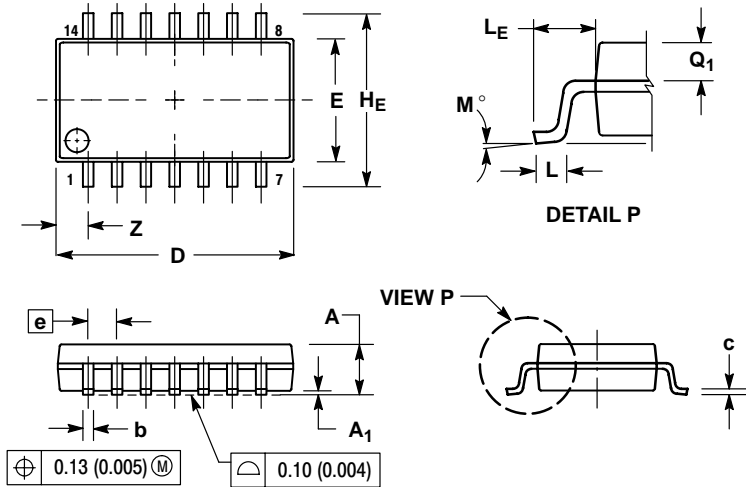

NOTES:

- 1 DIMENSIONING AND TOLERANCING PER ANSI Y14.5M, 1982.
- 2 CONTROLLING DIMENSION: MILLIMETER.
- 3 DIMENSIONS D AND E DO NOT INCLUDE MOLD FLASH OR PROTRUSIONS AND ARE MEASURED AT THE PARTING LINE. MOLD FLASH OR PROTRUSIONS SHALL NOT EXCEED 0.15 (0.006) PER SIDE.
- 4 TERMINAL NUMBERS ARE SHOWN FOR REFERENCE ONLY.
- 5 THE LEAD WIDTH DIMENSION (b) DOES NOT INCLUDE DAMBAR PROTRUSION. ALLOWABLE DAMBAR PROTRUSION SHALL BE 0.08 (0.003) TOTAL IN EXCESS OF THE LEAD WIDTH DIMENSION AT MAXIMUM MATERIAL CONDITION. DAMBAR CANNOT BE LOCATED ON THE LOWER RADIUS OR THE FOOT. MINIMUM SPACE BETWEEN PROTRUSIONS AND ADJACENT LEAD TO BE 0.46 (0.018).

DIM	MILLIMETERS		INCHES	
	MIN	MAX	MIN	MAX
A	---	2.05	---	0.081
A ₁	0.05	0.20	0.002	0.008
b	0.35	0.50	0.014	0.020
c	0.18	0.27	0.007	0.011
D	9.90	10.50	0.390	0.413
E	5.10	5.45	0.201	0.215
e	1.27 BSC		0.050 BSC	
H _E	7.40	8.20	0.291	0.323
0.50	0.50	0.85	0.020	0.033
L _E	1.10	1.50	0.043	0.059
M	0 °	10 °	0 °	10 °
Q ₁	0.70	0.90	0.028	0.035
Z	---	1.42	---	0.056

ON Semiconductor and  are registered trademarks of Semiconductor Components Industries, LLC (SCILLC). SCILLC reserves the right to make changes without further notice to any products herein. SCILLC makes no warranty, representation or guarantee regarding the suitability of its products for any particular purpose, nor does SCILLC assume any liability arising out of the application or use of any product or circuit, and specifically disclaims any and all liability, including without limitation special, consequential or incidental damages. "Typical" parameters which may be provided in SCILLC data sheets and/or specifications can and do vary in different applications and actual performance may vary over time. All operating parameters, including "Typicals" must be validated for each customer application by customer's technical experts. SCILLC does not convey any license under its patent rights nor the rights of others. SCILLC products are not designed, intended, or authorized for use as components in systems intended for surgical implant into the body, or other applications intended to support or sustain life, or for any other application in which the failure of the SCILLC product could create a situation where personal injury or death may occur. Should Buyer purchase or use SCILLC products for any such unintended or unauthorized application, Buyer shall indemnify and hold SCILLC and its officers, employees, subsidiaries, affiliates, and distributors harmless against all claims, costs, damages, and expenses, and reasonable attorney fees arising out of, directly or indirectly, any claim of personal injury or death associated with such unintended or unauthorized use, even if such claim alleges that SCILLC was negligent regarding the design or manufacture of the part. SCILLC is an Equal Opportunity/Affirmative Action Employer. This literature is subject to all applicable copyright laws and is not for resale in any manner.

PUBLICATION ORDERING INFORMATION

LITERATURE FULFILLMENT:

Literature Distribution Center for ON Semiconductor
P.O. Box 61312, Phoenix, Arizona 85082-1312 USA
Phone: 480-829-7710 or 800-344-3860 Toll Free USA/Canada
Fax: 480-829-7709 or 800-344-3867 Toll Free USA/Canada
Email: orderlit@onsemi.com

N. American Technical Support: 800-282-9855 Toll Free
USA/Canada

Japan: ON Semiconductor, Japan Customer Focus Center
2-9-1 Kamimeguro, Meguro-ku, Tokyo, Japan 153-0051
Phone: 81-3-5773-3850

ON Semiconductor Website: <http://onsemi.com>

Order Literature: <http://www.onsemi.com/litorder>

For additional information, please contact your local Sales Representative.