

MC78PC00 Series

Low Noise 150 mA Low Drop Out (LDO) Linear Voltage Regulator

The MC78PC00 are a series of CMOS linear voltage regulators with high output voltage accuracy, low supply current, low dropout voltage, and high Ripple Rejection. Each of these voltage regulators consists of an internal voltage reference, an error amplifier, resistors, a current limiting circuit and a chip enable circuit.

The dynamic Response to line and load is fast, which makes these products ideally suited for use in hand-held communication equipment.

The MC78PC00 series are housed in the SOT-23 5 lead package, for maximum board space saving.

MC78PC00 Features:

- Ultra-Low Supply Current: typical 35 μ A in ON mode with no load.
- Standby Mode: typical 0.1 μ A.
- Low Dropout Voltage: typical 0.2 V @ $I_{OUT} = 100$ mA.
- High Ripple Rejection: typical 70 dB @ $f = 1$ kHz.
- Low Temperature-Drift Coefficient of Output Voltage: typical ± 100 ppm/ $^{\circ}$ C.
- Excellent Line Regulation: typical 0.05%/V.
- High Accuracy Output Voltage: $\pm 2.0\%$.
- Fast Dynamic Response to Line and Load.
- Small Package: SOT-23 5 leads.
- Built-in Chip Enable circuit (CE input pin).
- Identical Pinout to the LP2980/1/2.

MC78PC00 Applications:

- Power source for cellular phones (GSM, CDMA, TDMA), Cordless Phones (PHS, DECT) and 2-way radios.
- Power source for domestic appliances such as cameras, VCRs and camcorders.
- Power source for battery-powered equipment.

Block Diagram

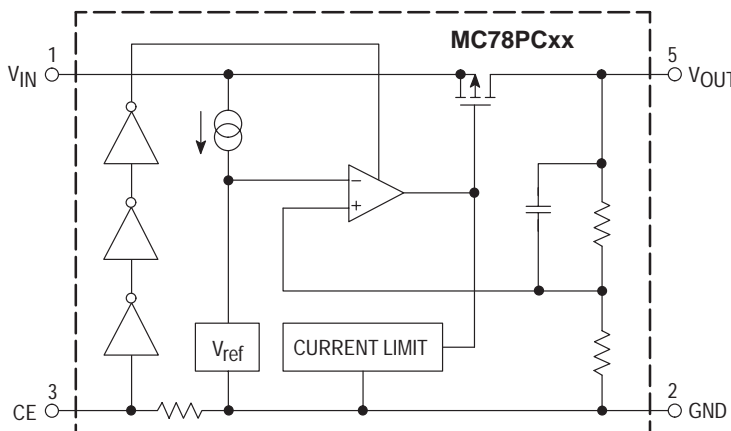

ON Semiconductor

Formerly a Division of Motorola

<http://onsemi.com>

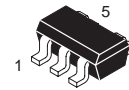

SOT-23-5

N SUFFIX

CASE 1212

PIN CONNECTIONS

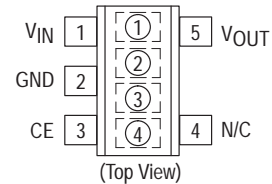

DEVICE MARKING

(4 digits are available for device marking)

Marking		Voltage Version
① ②	K8	1.8 V
	F5	2.5 V
	F8	2.8 V
	G0	3.0 V
	G3	3.3 V
	J0	5.0 V
③ ④	Lot Number	

PINS DESCRIPTION

Pin #	Symbol	Description
1	V_{IN}	Input Pin
2	GND	Ground Pin
3	CE	Chip Enable Pin
4	N/C	No Connection
5	V_{OUT}	Output Pin

ORDERING INFORMATION

Device	Package	Shipping
MC78PC18NTR	SOT-23 5 Leads	3000 Units Tape & Reel
MC78PC25NTR		
MC78PC28NTR		
MC78PC30NTR		
MC78PC33NTR		
MC78PC50NTR		

Other voltages are available. Consult your ON Semiconductor representative.

MC78PC00 Series

MAXIMUM RATINGS

Rating	Symbol	Value	Unit
Input Voltage	V_{IN}	9.0	V
Input Voltage	V_{CE}	$-0.3 - V_{IN} + 0.3$	V
Output Voltage	V_{OUT}	$-0.3 - V_{IN} + 0.3$	V
Power Dissipation	P_D	250	mW
Operating Temperature Range	T_A	-40 to +85	°C
Operating Junction Temperature	T_J	+125	°C
Maximum Junction Temperature	T_{Jmax}	+150	°C
Storage Temperature Range	T_{stg}	-55 to +125	°C

ELECTRICAL CHARACTERISTICS ($T_A = 25^\circ\text{C}$)

Characteristic	Symbol	Min	Typ	Max	Unit
Output Voltage ($V_{IN} = V_{OUT} + 1.0\text{ V}$, $I_{OUT} = 30\text{ mA}$) MC78PC18 MC78PC25 MC78PC28 MC78PC30 MC78PC33 MC78PC50	V_{OUT}	1.764 2.450 2.744 2.94 3.234 4.9	1.80 2.50 2.80 3.00 3.3 5.0	1.836 2.550 2.856 3.06 3.366 5.1	V
Nominal Output Current ($V_{IN} = V_{OUT} + 1.0\text{ V}$, $V_{OUT} = V_{OUT(nom)} - 0.1\text{ V}$)	I_{OUT}	150	-	-	mA
Load Regulation ($V_{IN} = V_{OUT} + 1.0\text{ V}$, $1.0\text{ mA} \leq I_{OUT} \leq 80\text{ mA}$)	$\Delta V_{OUT}/\Delta I_{OUT}$	-	12	40	mV
Supply Current in ON mode ($V_{IN} = V_{OUT} + 1.0\text{ V}$, $I_{OUT} = 0\text{ mA}$)	I_{SS}	-	35	70	μA
Supply Current in OFF mode, i.e. $V_{CE} = \text{GND}$ ($V_{IN} = V_{OUT} + 1.0\text{ V}$, $I_{OUT} = 0\text{ mA}$)	$I_{standby}$	-	0.1	1.0	μA
Ripple Rejection ($f = 1.0\text{ kHz}$, Ripple 0.5 V_{p-p} , $V_{IN} = V_{OUT} + 1.0\text{ V}$)	RR	-	70	-	dB
Input Voltage	V_{IN}	-	-	8.0	V
Output Voltage Temperature Coefficient ($I_{OUT} = 30\text{ mA}$, $-40^\circ\text{C} \leq T_A \leq +85^\circ\text{C}$)	$\Delta V_{OUT}/\Delta T$	-	± 100	-	ppm/°C
Short Circuit Current Limit ($V_{OUT} = 0\text{ V}$)	I_{lim}	-	50	-	mA
CE Pull-down Resistance	R_{PD}	2.5	5.0	10	$\text{M}\Omega$
CE Input Voltage "H" (ON Mode)	V_{IH}	1.5	-	V_{IN}	V
CE Input Voltage "L" (OFF Mode)	V_{IL}	0	-	0.25	V
Output Noise Voltage ($f = 10\text{ Hz to } 100\text{ kHz}$)	e_n	-	30	-	μV_{rms}

ELECTRICAL CHARACTERISTICS by OUTPUT VOLTAGE V_{OUT} ($T_A = 25^\circ\text{C}$)

Characteristic	Symbol	Min	Typ	Max	Unit
Dropout Voltage ($I_{OUT} = 100\text{ mA}$) $1.8 \leq V_{OUT} \leq 1.9$ $2.0 \leq V_{OUT} \leq 2.4$ $2.5 \leq V_{OUT} \leq 2.7$ $2.8 \leq V_{OUT} \leq 3.3$ $3.4 \leq V_{OUT} \leq 6.0$	V_{DIF}	- - - - -	0.60 0.35 0.24 0.20 0.17	1.40 0.70 0.35 0.30 0.26	V
Line Regulation ($V_{OUT} + 0.5\text{ V} \leq V_{IN} \leq 8.0\text{ V}$, $I_{OUT} = 30\text{ mA}$)	$\Delta V_{OUT}/\Delta V_{IN}$	-	0.05	0.20	%/V

MC78PC00 Series

OPERATION

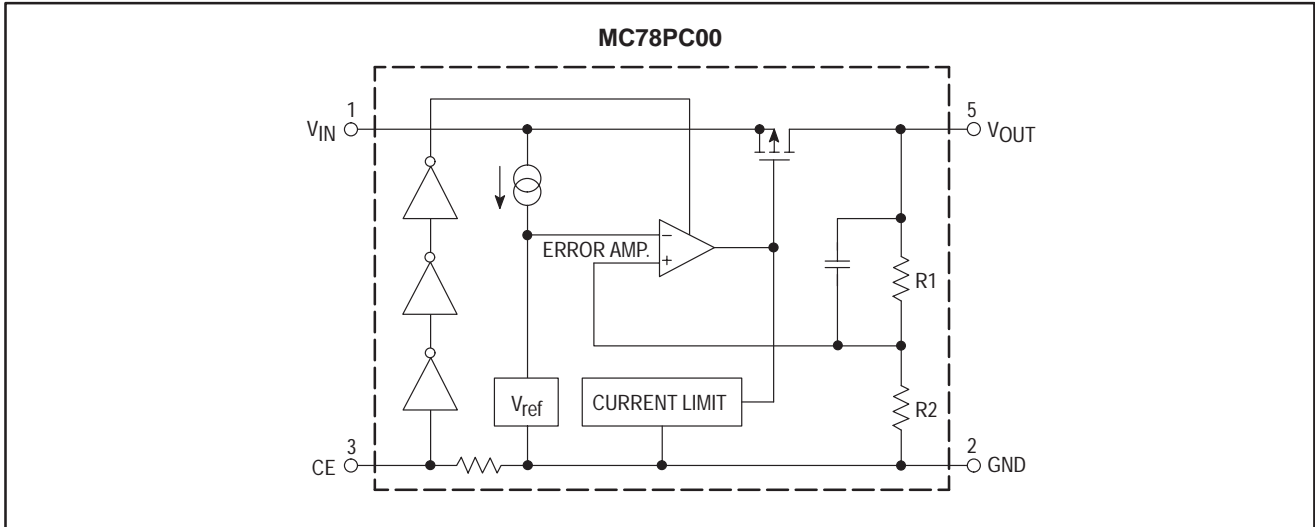

In the MC78PC00, the output voltage V_{OUT} is detected by $R1$, $R2$. The detected output voltage is then compared to the internal voltage reference by the error amplifier. Both a current limiting circuit for short circuit protection, and a chip enable circuit are included.

MC78PC00 Series

TEST CIRCUITS

Figure 1. Standard Test Circuits

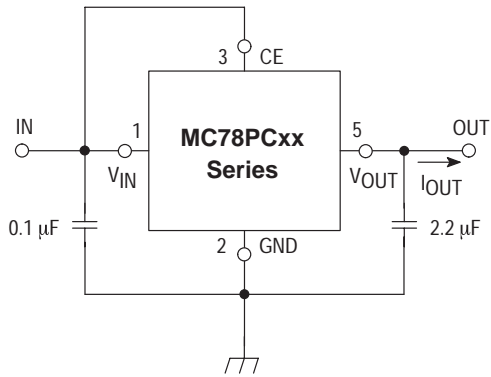

Figure 2. Supply Current Test Circuit

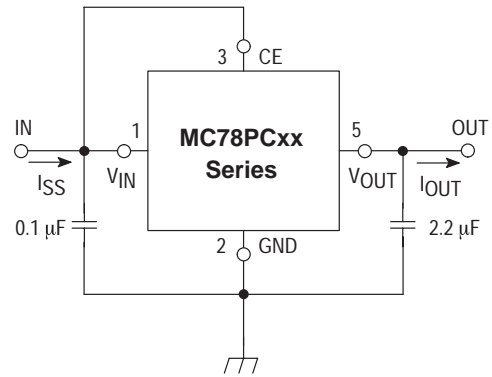

Figure 3. Ripple Rejection, Line Transient Response Test Circuit

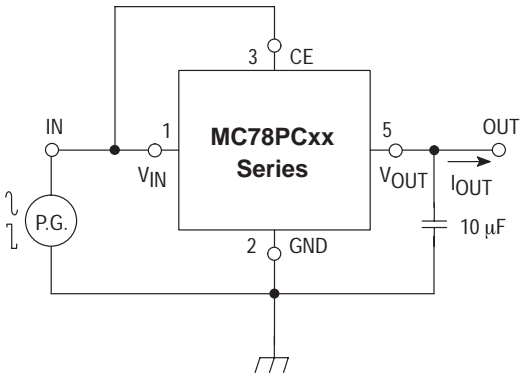
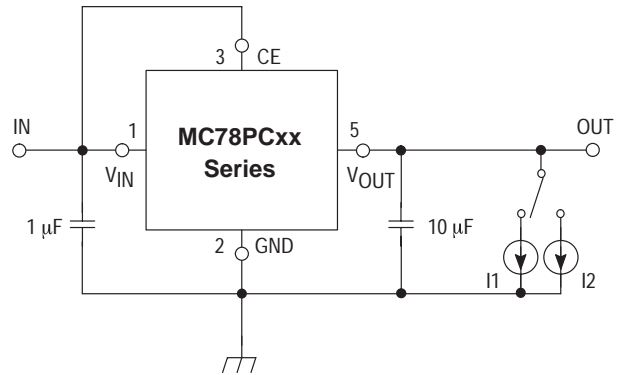

Figure 4. Load Transient Response Test Circuit



MC78PC00 Series

Figure 5. MC78PC18 Output Voltage versus Output Current

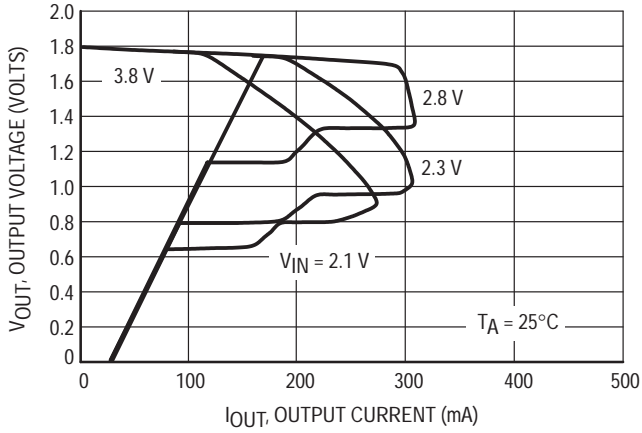

Figure 6. MC78PC30 Output Voltage versus Output Current

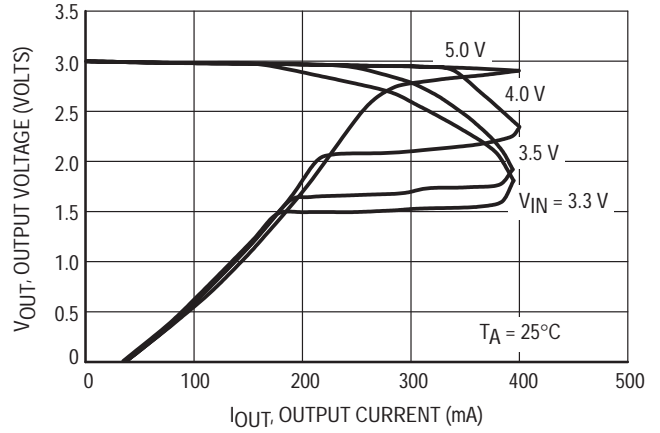

Figure 7. MC78PC40 (4.0 V) Output Voltage versus Output Current

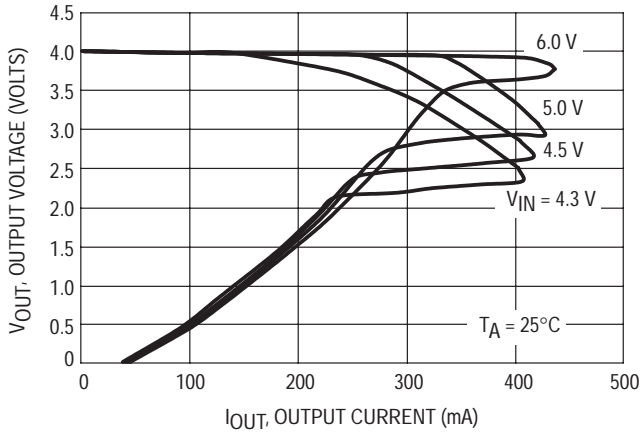

Figure 8. MC78PC50 Output Voltage versus Output Current

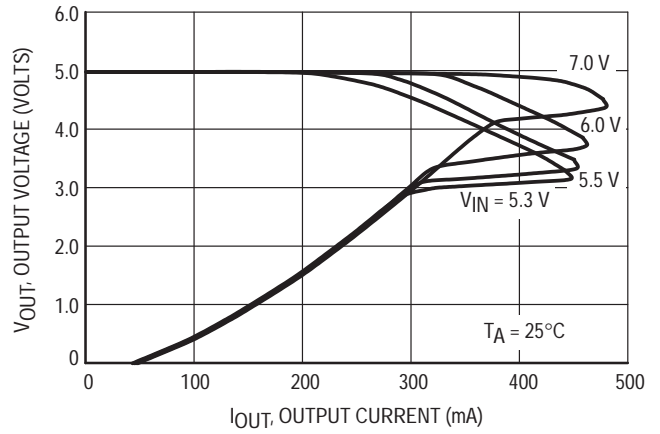

Figure 9. MC78PC18 Output Voltage versus Input Voltage

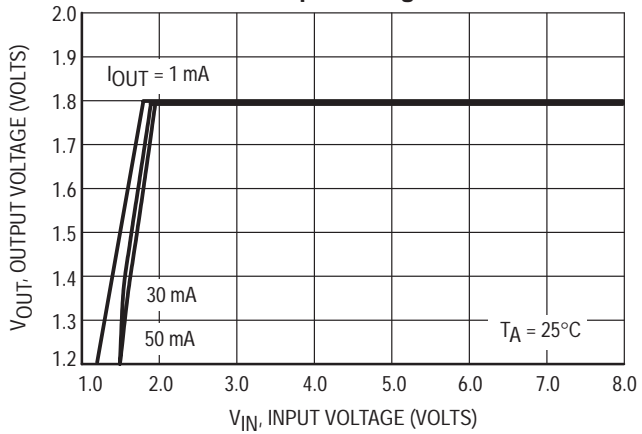
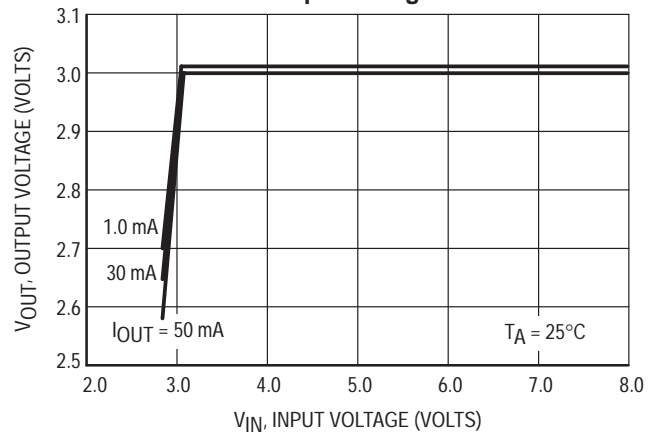

Figure 10. MC78PC30 Output Voltage versus Input Voltage



MC78PC00 Series

Figure 11. MC78PC40 (4.0 V) Output Voltage versus Input Voltage

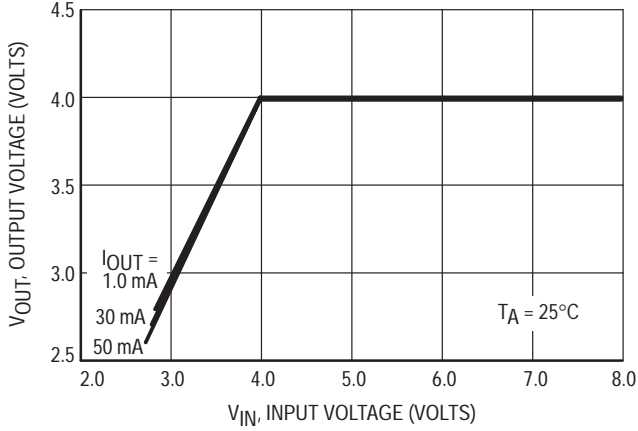

Figure 12. MC78PC50 Output Voltage versus Input Voltage

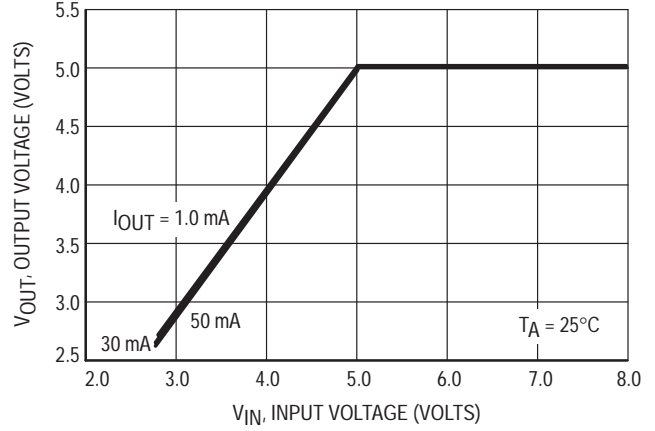

Figure 13. MC78PC18 Dropout Voltage versus Output Current

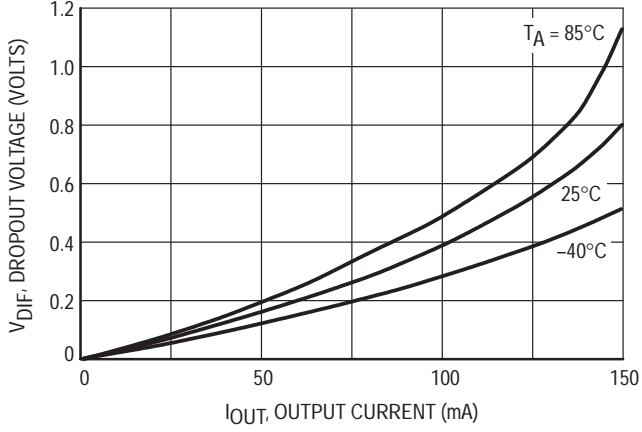

Figure 14. MC78PC30 Dropout Voltage versus Output Current

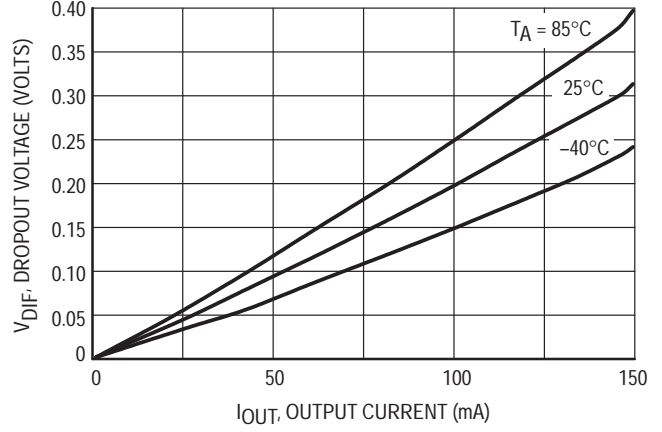

Figure 15. MC78PC40 (4.0 V) Dropout Voltage versus Output Current

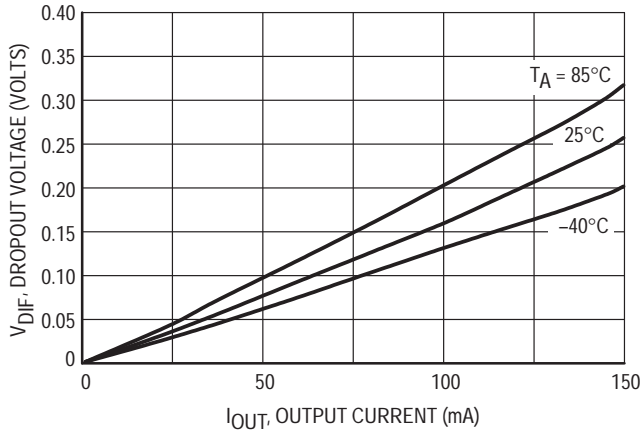
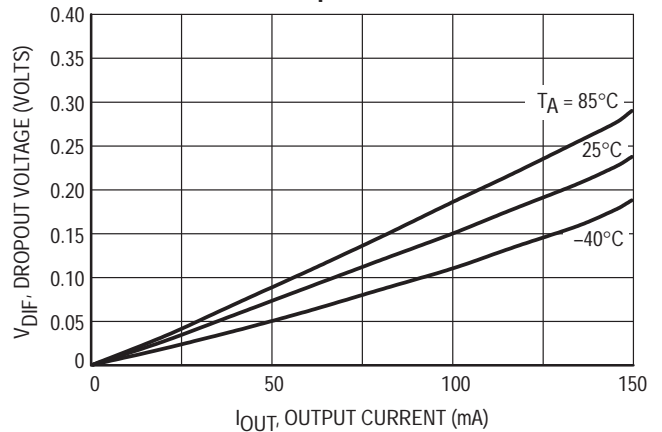

Figure 16. MC78PC50 Dropout Voltage versus Output Current



MC78PC00 Series

Figure 17. MPC78PC18 Output Voltage versus Temperature

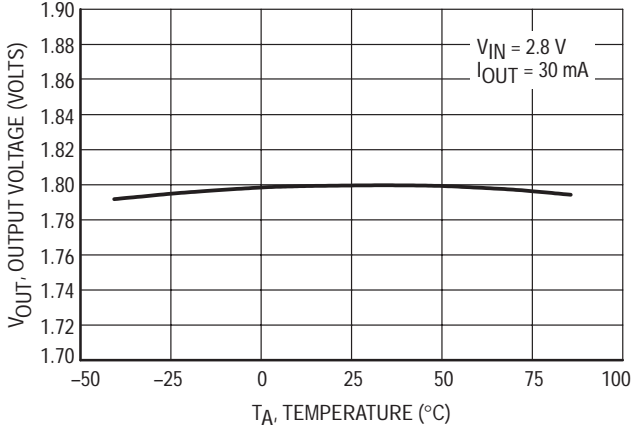

Figure 18. MC78PC30 Output Voltage versus Temperature

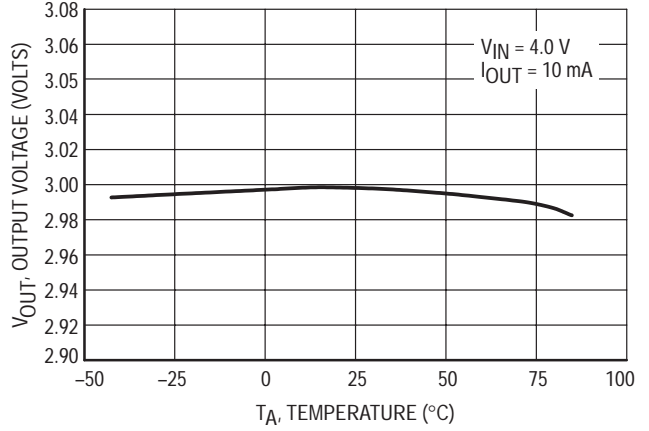

Figure 19. MC78PC40 (4.0 V) Output Voltage versus Temperature

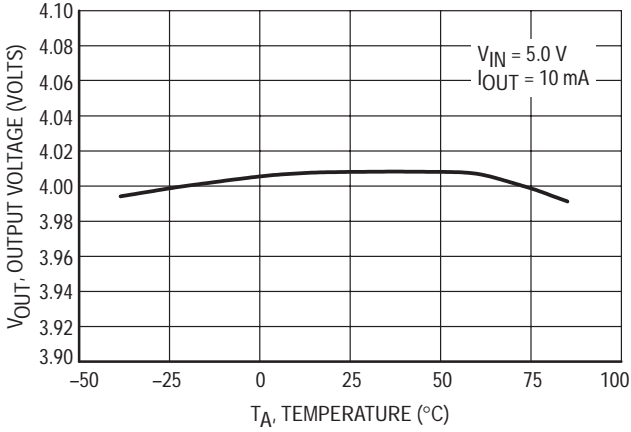

Figure 20. MC78PC50 Output Voltage versus Temperature

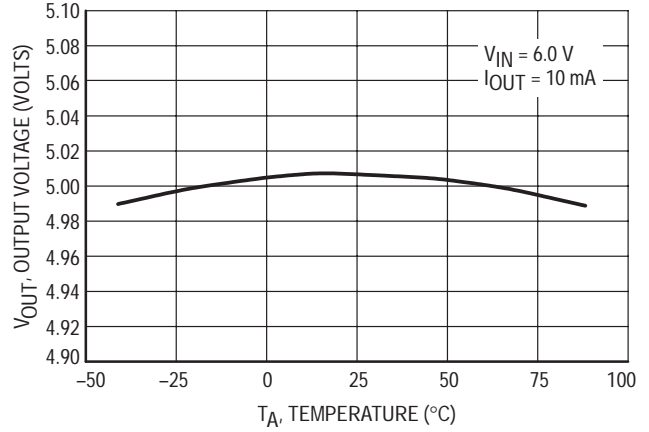

Figure 21. MC78PC18 Supply Current versus Input Voltage

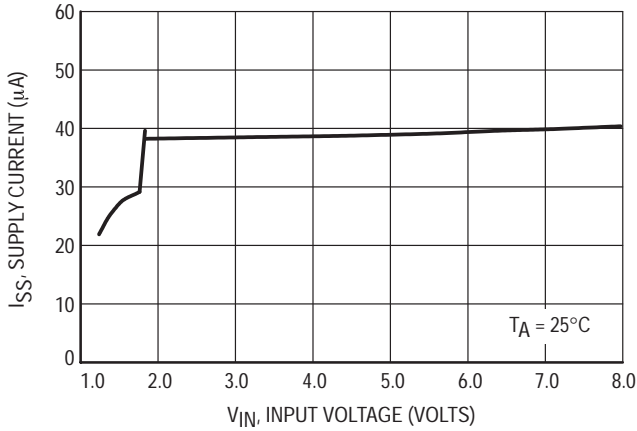
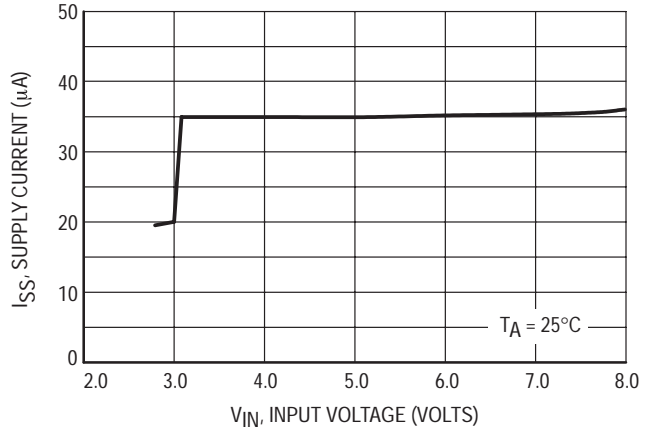

Figure 22. MC78PC30 Supply Current versus Input Voltage



MC78PC00 Series

Figure 23. MC78PC40 (4.0 V) Supply Current versus Input Voltage

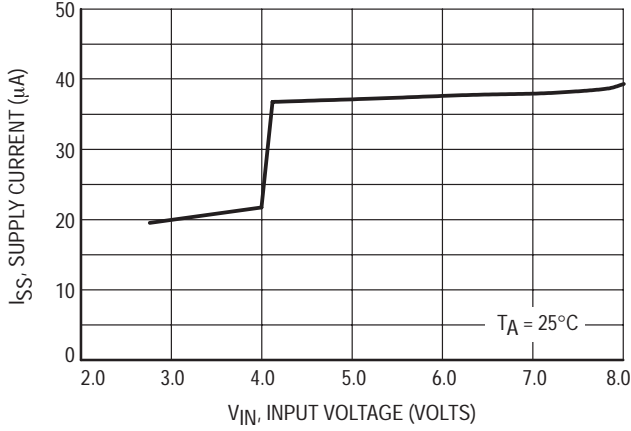

Figure 24. MC78PC50 Supply Current versus Input Voltage

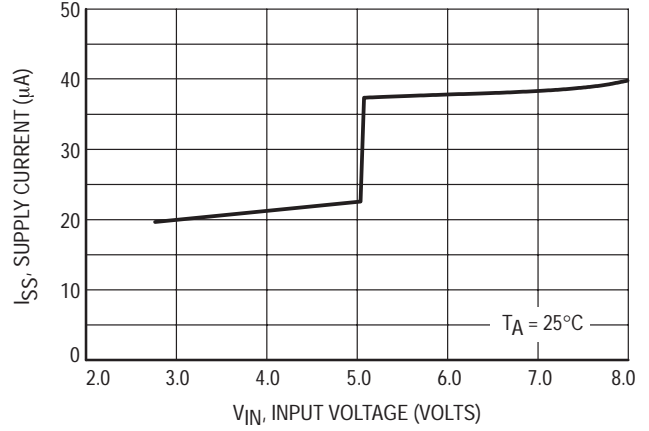

Figure 25. MC78PC30 Supply Current versus Temperature

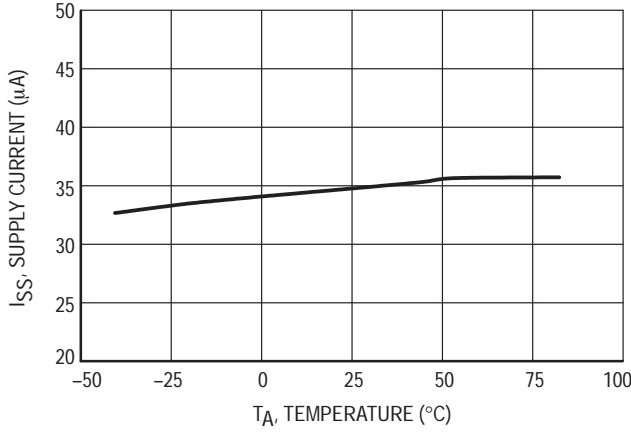

Figure 26. MC78PC40 (4.0 V) Supply Current versus Temperature

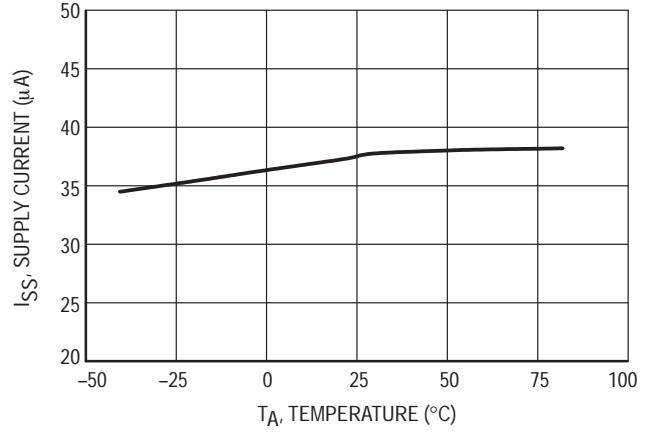

Figure 27. MC78PC50 Supply Current versus Temperature

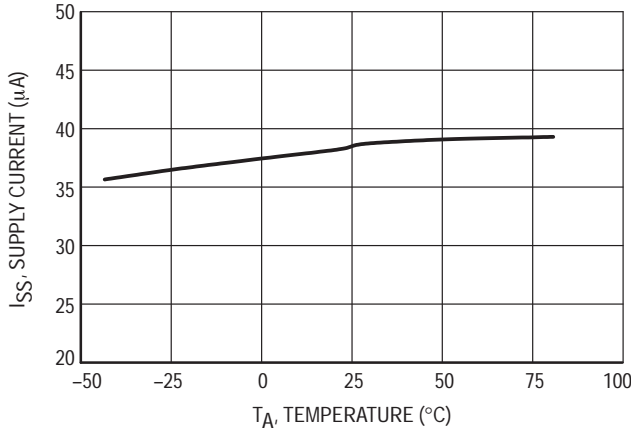
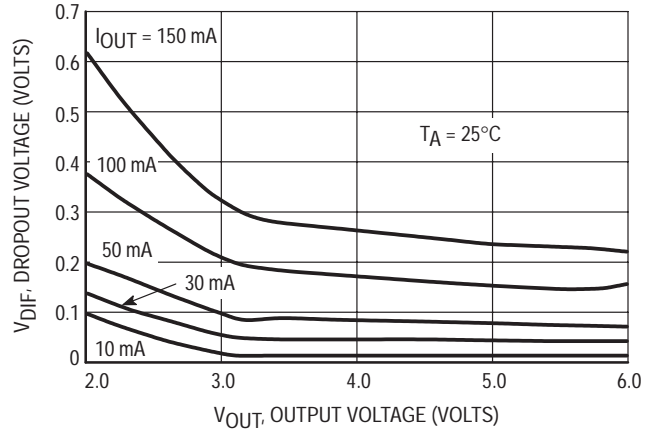

Figure 28. Dropout Voltage versus Output Voltage



MC78PC00 Series

Figure 29. MC78PC18 Ripple Rejection versus Frequency

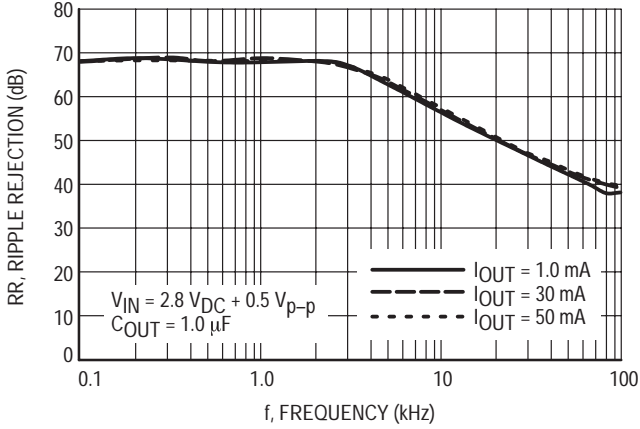

Figure 30. MC78PC18 Ripple Rejection versus Frequency

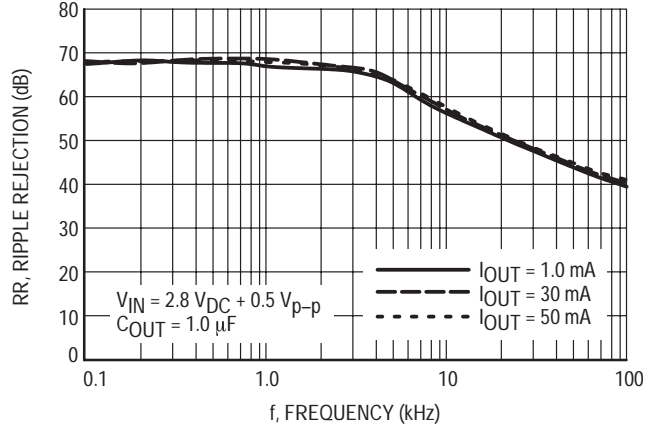

Figure 31. MC78PC30 Ripple Rejection versus Frequency

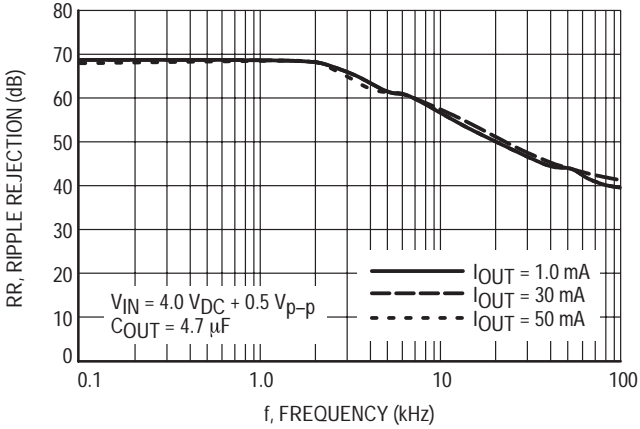

Figure 32. MC78PC30 Ripple Rejection versus Frequency

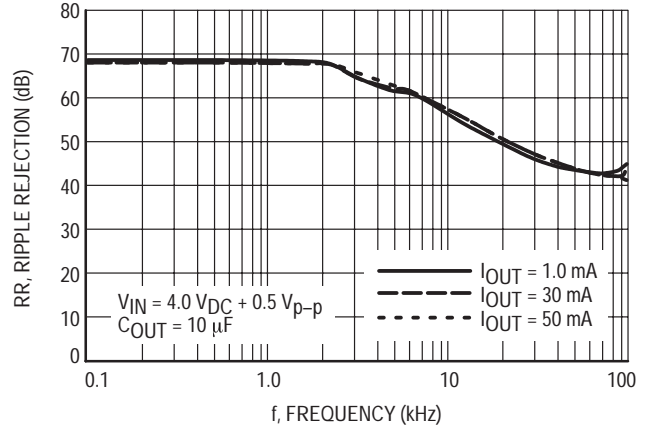

Figure 33. MC78PC40 (4.0 V) Ripple Rejection versus Frequency

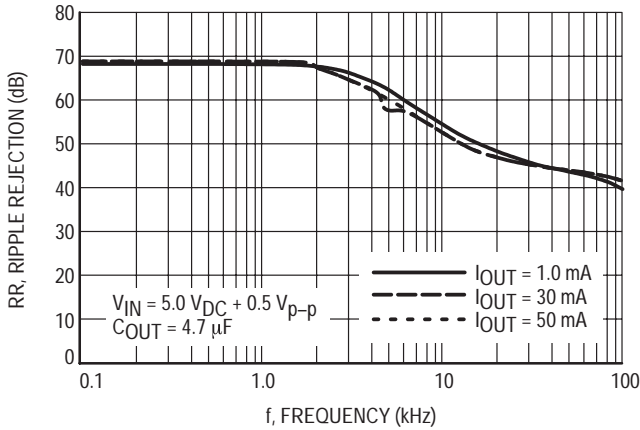
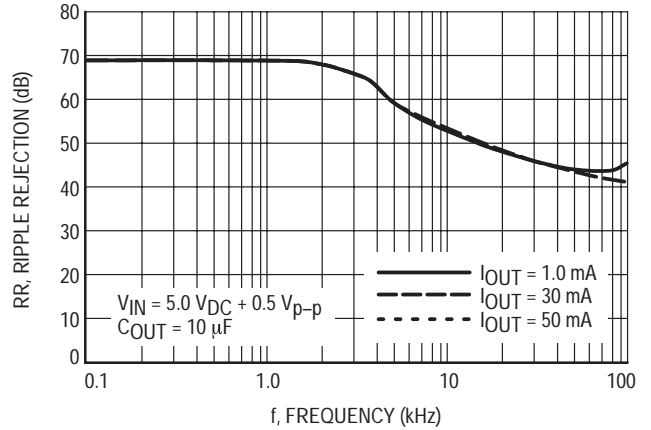

Figure 34. MC78PC40 (4.0 V) Ripple Rejection versus Frequency



MC78PC00 Series

Figure 35. MC78PC50 Ripple Rejection versus Frequency

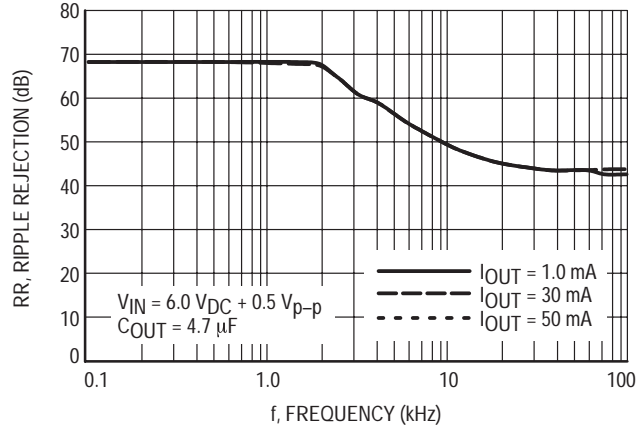

Figure 36. MC78PC50 Ripple Rejection versus Frequency

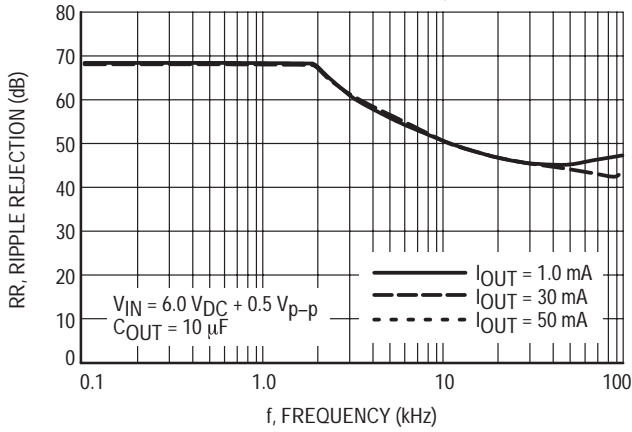

Figure 37. MC78PC30 Ripple Rejection versus Input Voltage (DC Bias)

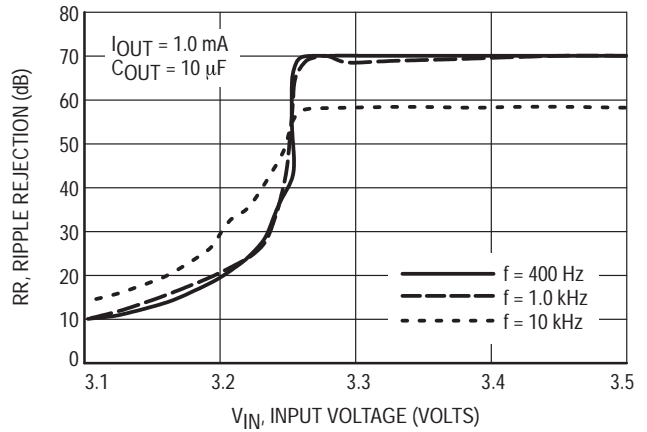

Figure 38. MC78PC30 Ripple Rejection versus Input Voltage (DC Bias)

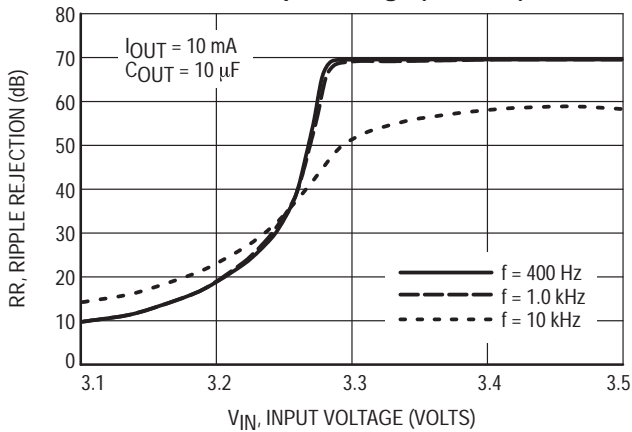
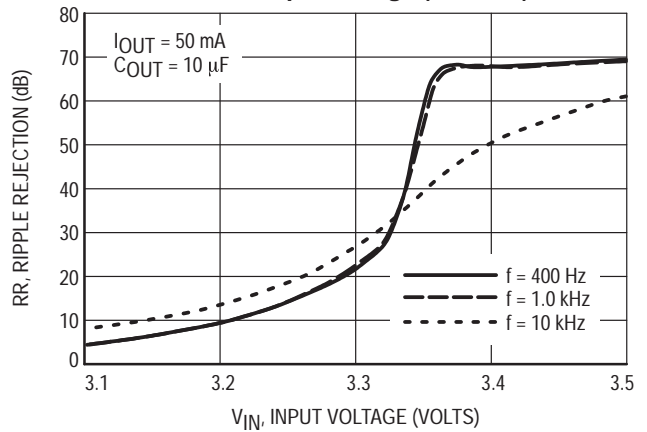

Figure 39. MC78PC30 Ripple Rejection versus Input Voltage (DC Bias)



MC78PC00 Series

Figure 40. MC78PC30 Line Transient Response

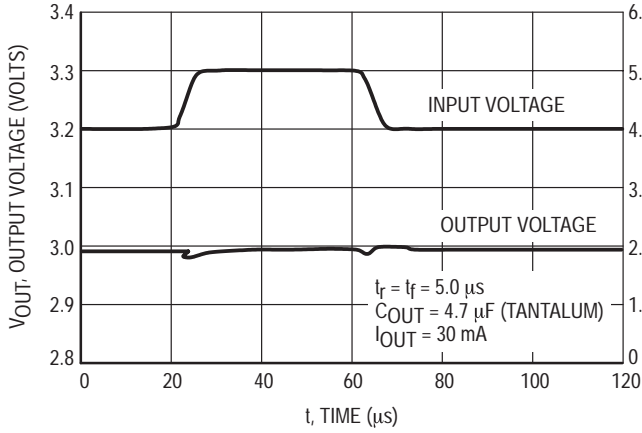

Figure 41. MC78PC30 Line Transient Response

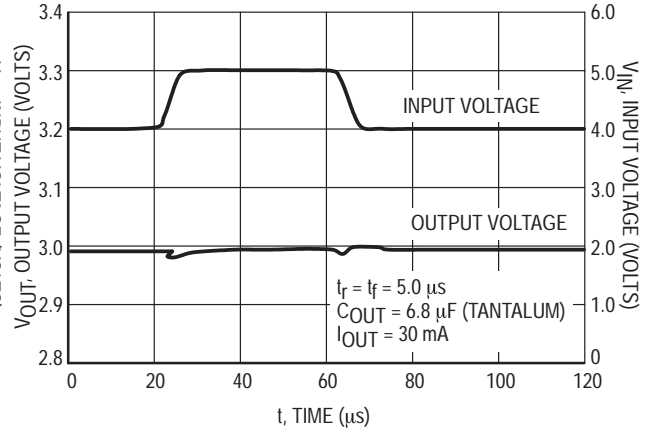

Figure 42. MC78PC30 Line Transient Response

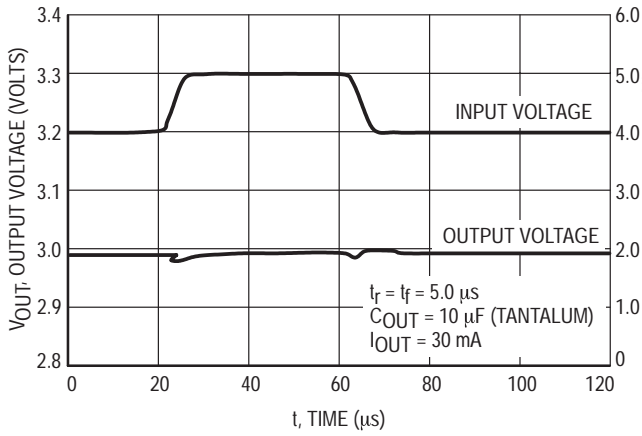

Figure 43. MC78PC30 Load Transient Response

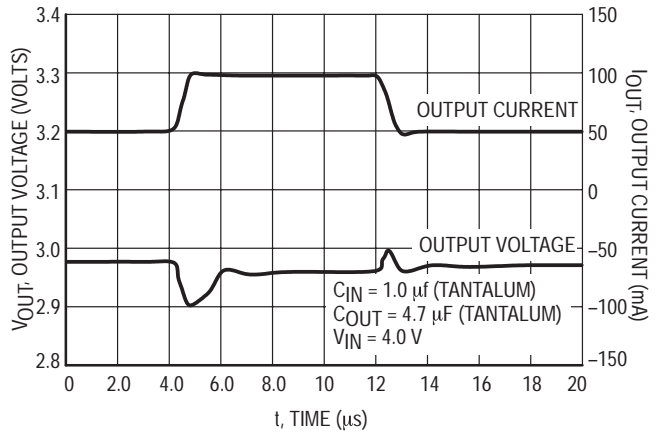

Figure 44. MC78PC30 Load Transient Response

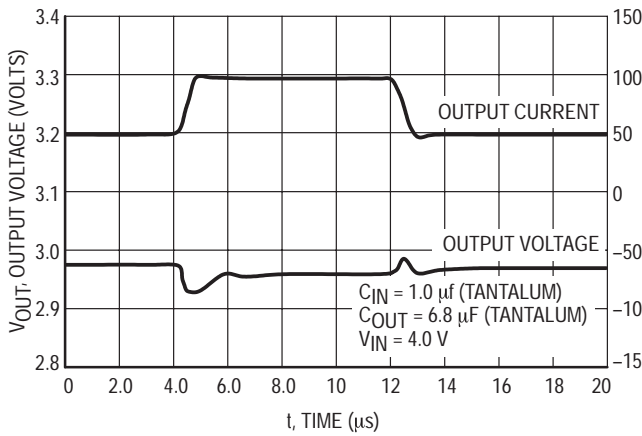
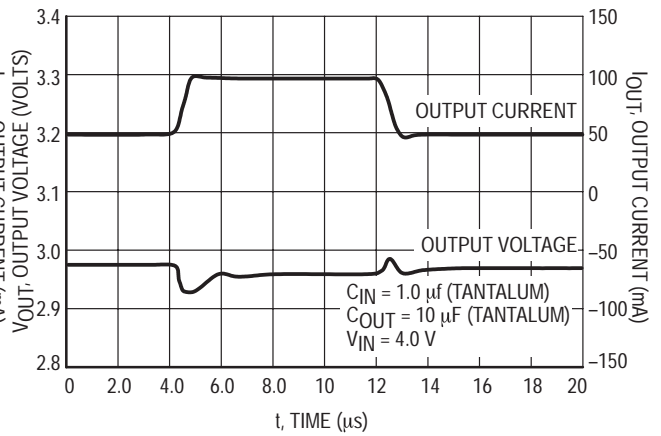

Figure 45. MC78PC30 Load Transient Response



MC78PC00 Series

APPLICATION HINTS

When using these circuits, please be sure to observe the following points:

- Phase compensation is made for securing stable operation even if the load current varies. For this reason, be sure to use a capacitor C_{OUT} with good frequency characteristics and ESR (Equivalent Series Resistance) as described in the graphs on page 11. On page 11, the relations between I_{OUT} (Output Current)

and ESR of Output Capacitor are shown. The conditions where the white noise level is under $40 \mu\text{V}$ (Avg.) are marked by the shaded area in the graph. (note: When additional ceramic capacitors are connected to the Output Pin with Output capacitor for phase compensation, there is a possibility that the operation will be unstable. Because of this, test these circuits with as same external components as ones to be used on the PCB).

Figure 46. Measuring Circuit for White Noise: MC78PC30

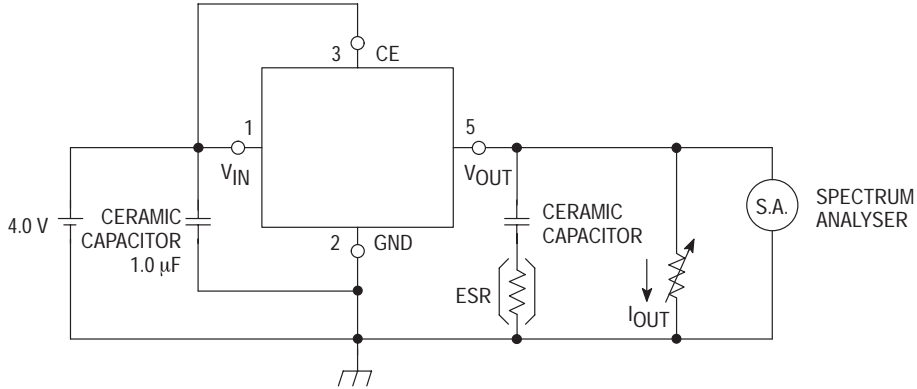

MEASURING CONDITIONS: (1) FREQUENCY RANGE: 10 Hz TO 1.0 MHz
(2) TEMPERATURE: 25°C

- Please be sure the V_{in} and GND lines are sufficiently wide. When the impedance of these lines is high, there is a chance to pick up noise or to malfunction.
- Connect the capacitor with a capacitance of $1.0 \mu\text{F}$ or more between V_{in} and GND as close as possible to V_{in} or GND.
- Set external components, especially the Output Capacitor, as close as possible to the circuit, and make the wiring as short as possible.

Figure 47. Typical Application

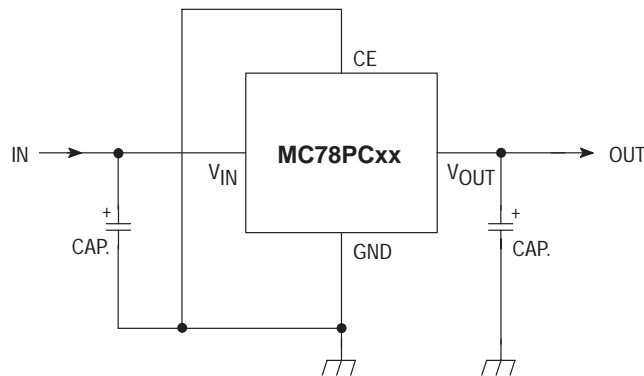

MC78PC00 Series

Figure 48. Ceramic Capacitor 4.7 μF

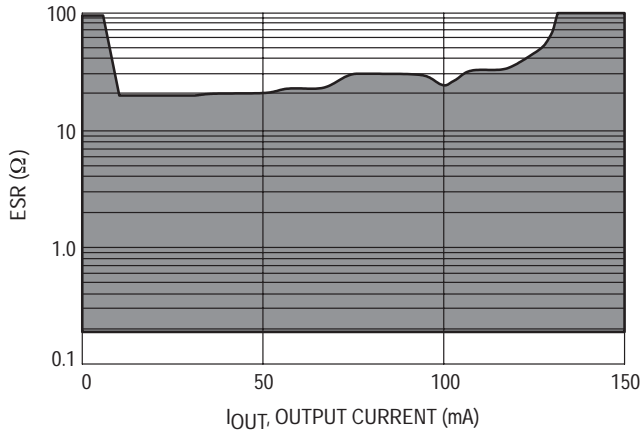

Figure 49. Ceramic Capacitor 6.8 μF

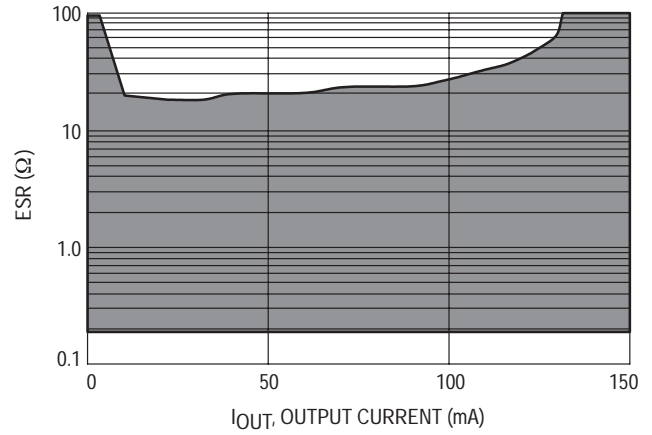
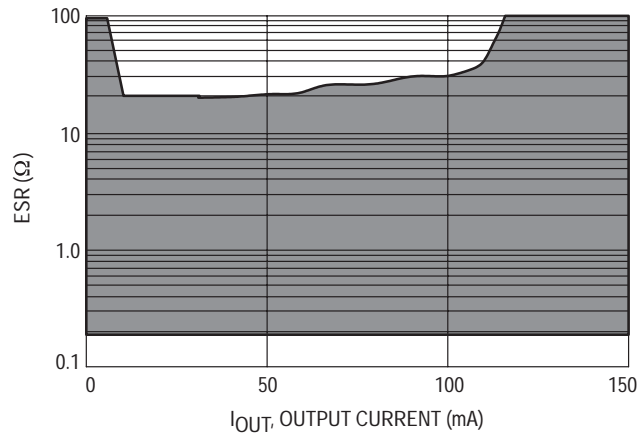

Figure 50. Ceramic Capacitor 10 μF



MC78PC00 Series

TAPE AND REEL INFORMATION

Component Taping Orientation for 5L SOT-23 Devices

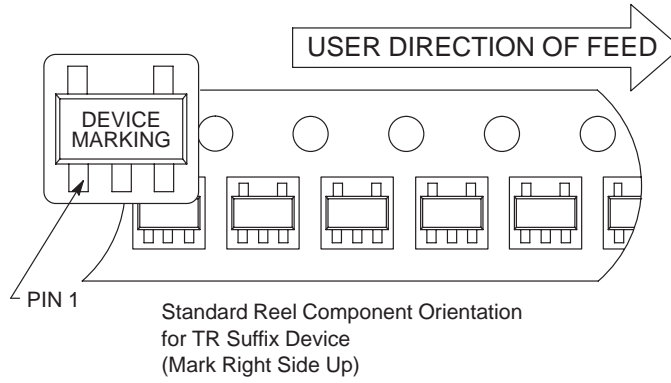

Tape & Reel Specifications Table

Package	Tape Width (W)	Pitch (P)	Part Per Full Reel	Reel Diameter
5L SOT-23	8 mm	4 mm	3000	7 inches

MC78PC00 Series

PACKAGE DIMENSIONS

SOT-23-5
N SUFFIX
 PLASTIC PACKAGE
 CASE 1212-01
 ISSUE O

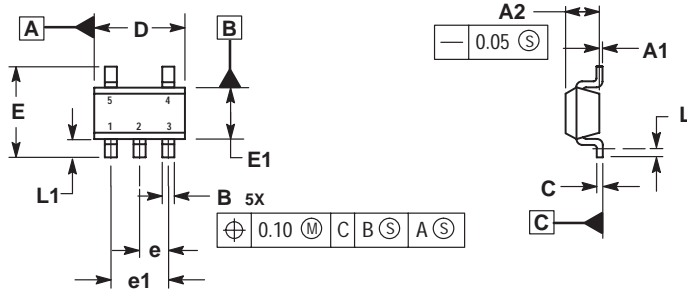

- NOTES:
 1. DIMENSIONS ARE IN MILLIMETERS.
 2. INTERPRET DIMENSIONS AND TOLERANCES PER ASME Y14.5M, 1994.
 3. DATUM C IS A SEATING PLANE.

DIM	MILLIMETERS	
	MIN	MAX
A1	0.00	0.10
A2	1.00	1.30
B	0.30	0.50
C	0.10	0.25
D	2.80	3.00
E	2.50	3.10
E1	1.50	1.80
e	0.95 BSC	
e1	1.90 BSC	
L	0.20	—
L1	0.45	0.75

Recommended Footprint for SOT-23-5 Surface Mount Applications

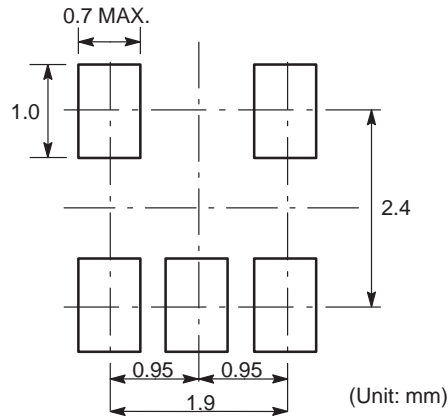

SOT-23-5

MC78PC00 Series

ON Semiconductor and  are trademarks of Semiconductor Components Industries, LLC (SCILLC). SCILLC reserves the right to make changes without further notice to any products herein. SCILLC makes no warranty, representation or guarantee regarding the suitability of its products for any particular purpose, nor does SCILLC assume any liability arising out of the application or use of any product or circuit, and specifically disclaims any and all liability, including without limitation special, consequential or incidental damages. "Typical" parameters which may be provided in SCILLC data sheets and/or specifications can and do vary in different applications and actual performance may vary over time. All operating parameters, including "Typicals" must be validated for each customer application by customer's technical experts. SCILLC does not convey any license under its patent rights nor the rights of others. SCILLC products are not designed, intended, or authorized for use as components in systems intended for surgical implant into the body, or other applications intended to support or sustain life, or for any other application in which the failure of the SCILLC product could create a situation where personal injury or death may occur. Should Buyer purchase or use SCILLC products for any such unintended or unauthorized application, Buyer shall indemnify and hold SCILLC and its officers, employees, subsidiaries, affiliates, and distributors harmless against all claims, costs, damages, and expenses, and reasonable attorney fees arising out of, directly or indirectly, any claim of personal injury or death associated with such unintended or unauthorized use, even if such claim alleges that SCILLC was negligent regarding the design or manufacture of the part. SCILLC is an Equal Opportunity/Affirmative Action Employer.

PUBLICATION ORDERING INFORMATION

USA/EUROPE Literature Fulfillment:

Literature Distribution Center for ON Semiconductor
P.O. Box 5163, Denver, Colorado 80217 USA
Phone: 303-675-2175 or 800-344-3860 Toll Free USA/Canada
Fax: 303-675-2176 or 800-344-3867 Toll Free USA/Canada
Email: ONlit@hibbertco.com

Fax Response Line*: 303-675-2167
800-344-3810 Toll Free USA/Canada
*To receive a Fax of our publications

N. America Technical Support: 800-282-9855 Toll Free USA/Canada

ASIA/PACIFIC: LDC for ON Semiconductor – Asia Support

Phone: 303-675-2121 (Tue-Fri 9:00am to 1:00pm, Hong Kong Time)
Email: ONlit-asia@hibbertco.com

JAPAN: ON Semiconductor, Japan Customer Focus Center
4-32-1 Nishi-Gotanda, Shinagawa-ku, Tokyo, Japan 141-8549

Phone: 81-3-5487-8345
Email: r14153@onsemi.com

ON Semiconductor Website: <http://onsemi.com>

For additional information, please contact your local Sales Representative.