



Preliminary Information

Low $r_{DS(on)}$ Small-Signal MOSFETs TMOS Single P-Channel Field Effect Transistors

Part of the GreenLine™ Portfolio of devices with energy-conserving traits.

These miniature surface mount MOSFETs utilize Motorola's High Cell Density, HDTMOS process. Low $r_{DS(on)}$ assures minimal power loss and conserves energy, making this device ideal for use in small power management circuitry. Typical applications are dc-dc converters, power management in portable and battery-powered products such as computers, printers, PCMCIA cards, cellular and cordless telephones.

- Low $r_{DS(on)}$ Provides Higher Efficiency and Extends Battery Life
- Miniature TSOP 6 Surface Mount Package Saves Board Space
- Visit our Web Site at <http://www.mot-sps.com/ospd>

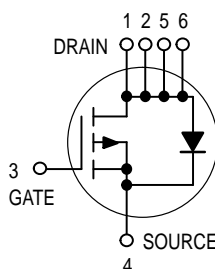

MGSF3441VT1

Motorola Preferred Device

P-CHANNEL
ENHANCEMENT-MODE
TMOS MOSFET
 $r_{DS(on)} = 78 \text{ m}\Omega$ (TYP)

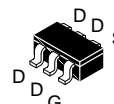

CASE 318G-02, Style 1
TSOP 6 PLASTIC

2.5V RATED

MAXIMUM RATINGS ($T_J = 25^\circ\text{C}$ unless otherwise noted)

Rating	Symbol	Value	Unit
Drain-to-Source Voltage	V_{DSS}	20	Vdc
Gate-to-Source Voltage — Continuous	V_{GS}	± 8.0	Vdc
Drain Current — Continuous @ $T_A = 25^\circ\text{C}$ — Pulsed Drain Current ($t_p \leq 10 \mu\text{s}$)	I_D I_{DM}	3.3 20	A
Total Power Dissipation @ $T_A = 25^\circ\text{C}$ Mounted on FR4 $t \leq 5 \text{ sec}$	P_D	2.0	W
Operating and Storage Temperature Range	T_J, T_{stg}	-55 to 150	$^\circ\text{C}$
Thermal Resistance — Junction-to-Ambient	$R_{\theta JA}$	128	$^\circ\text{C/W}$
Maximum Lead Temperature for Soldering Purposes, for 10 seconds	T_L	260	$^\circ\text{C}$

ORDERING INFORMATION

Device	Reel Size	Tape Width	Quantity
MGSF3441VT1	7"	8 mm embossed tape	3000
MGSF3441VT3	13"	8 mm embossed tape	10,000

GreenLine is a trademark of Motorola, Inc.

HDTMOS is a trademark of Motorola, Inc. TMOS is a registered trademark of Motorola, Inc.

Thermal Clad is a trademark of the Bergquist Company.

This document contains information on a product under development. Motorola reserves the right to change or discontinue this product without notice.

Preferred devices are Motorola recommended choices for future use and best overall value.

MGSF3441VT1**ELECTRICAL CHARACTERISTICS** ($T_A = 25^\circ\text{C}$ unless otherwise noted)

Characteristic	Symbol	Min	Typ	Max	Unit
----------------	--------	-----	-----	-----	------

OFF CHARACTERISTICS

Drain-to-Source Breakdown Voltage ($V_{GS} = 0\text{ Vdc}$, $I_D = 10\ \mu\text{A}$)	$V_{(BR)DSS}$	20	—	—	Vdc
Zero Gate Voltage Drain Current ($V_{DS} = 20\text{ Vdc}$, $V_{GS} = 0\text{ Vdc}$) ($V_{DS} = 20\text{ Vdc}$, $V_{GS} = 0\text{ Vdc}$, $T_J = 70^\circ\text{C}$)	I_{DSS}	—	—	1.0 4.0	μAdc
Gate-Body Leakage Current ($V_{GS} = \pm 8.0\text{ Vdc}$, $V_{DS} = 0$)	I_{GSS}	—	—	± 100	nAdc

ON CHARACTERISTICS(1)

Gate Threshold Voltage ($V_{DS} = V_{GS}$, $I_D = 250\ \mu\text{Adc}$)	$V_{GS(th)}$	0.45	—	—	Vdc
Static Drain-to-Source On-Resistance ($V_{GS} = 4.5\text{ Vdc}$, $I_D = 3.3\text{ A}$) ($V_{GS} = 2.5\text{ Vdc}$, $I_D = 2.9\text{ A}$)	$r_{DS(on)}$	—	0.078 0.110	0.090 0.135	Ohms

DYNAMIC CHARACTERISTICS

Input Capacitance	($V_{DS} = 5.0\text{ V}$)	C_{iss}	—	90	—	pF
Output Capacitance	($V_{DS} = 5.0\text{ V}$)	C_{oss}	—	50	—	
Transfer Capacitance	($V_{DG} = 5.0\text{ V}$)	C_{rss}	—	10	—	

SWITCHING CHARACTERISTICS(2)

Turn-On Delay Time	$(V_{DD} = 15\text{ Vdc}$, $I_D = 1.0\text{ A}$, $V_{GEN} = 10\text{ V}$, $R_L = 10\ \Omega$)	$t_{d(on)}$	—	27	50	ns
Rise Time		t_r	—	17	30	
Turn-Off Delay Time		$t_{d(off)}$	—	52	80	
Fall Time		t_f	—	45	70	
Gate Charge		Q_T	—	3000	—	pC

SOURCE-DRAIN DIODE CHARACTERISTICS

Continuous Current	I_S	—	—	1.0	A
Pulsed Current	I_{SM}	—	—	20	A
Forward Voltage(2)	V_{SD}	—	0.80	1.2	V

(1) Pulse Test: Pulse Width $\leq 300\ \mu\text{s}$, Duty Cycle $\leq 2\%$.

(2) Switching characteristics are independent of operating junction temperature.

TYPICAL ELECTRICAL CHARACTERISTICS

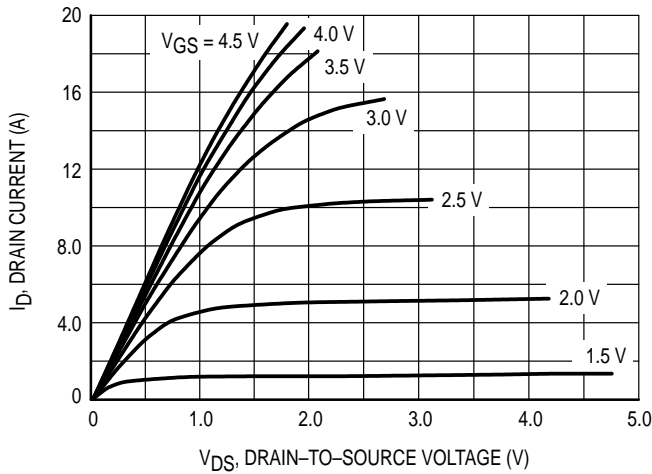

Figure 1. Output Characteristics

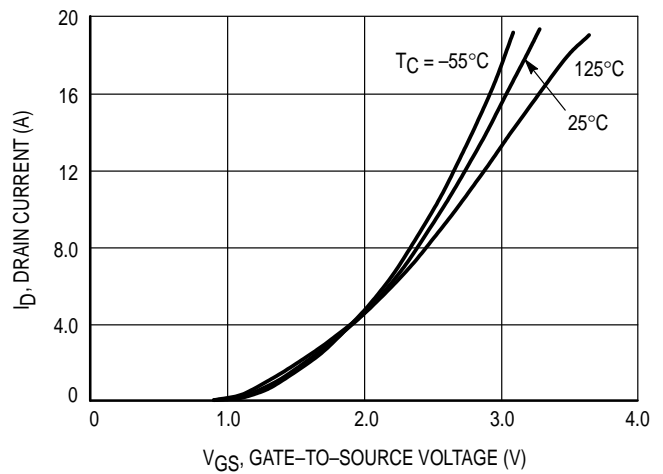

Figure 2. Transfer Characteristics

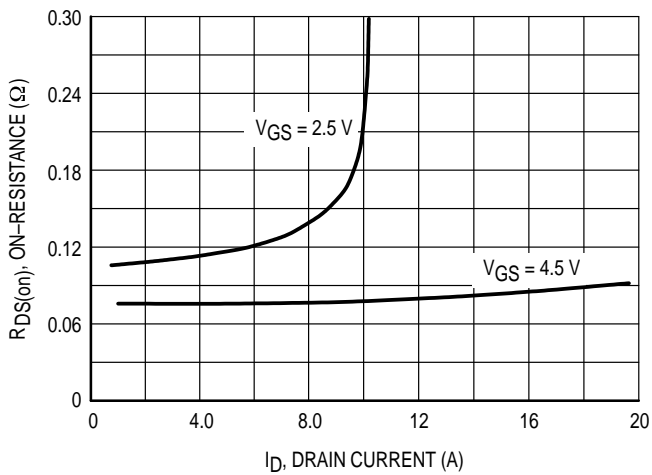

Figure 3. On-Resistance versus Drain Current

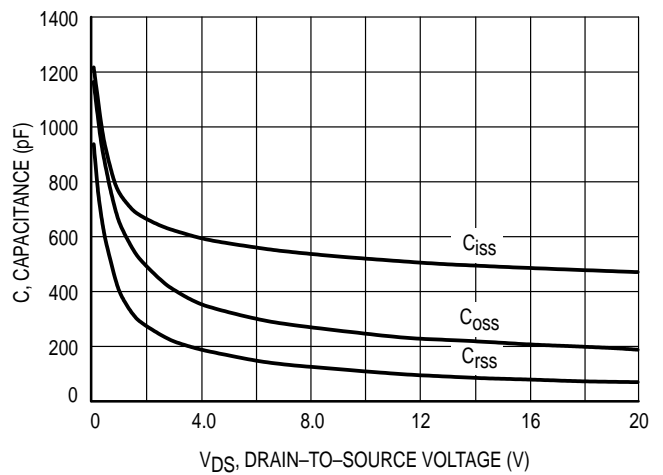

Figure 4. Capacitance

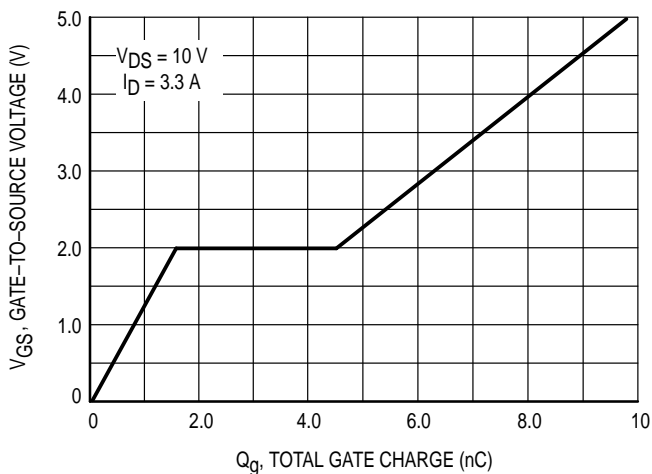

Figure 5. Gate Charge

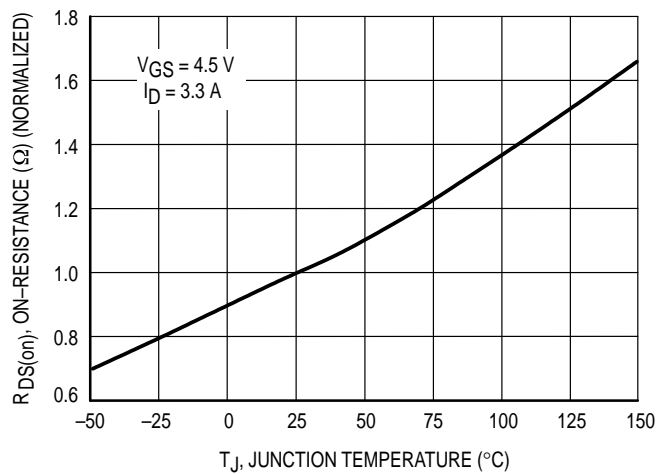

Figure 6. On-Resistance versus Junction Temperature

TYPICAL ELECTRICAL CHARACTERISTICS

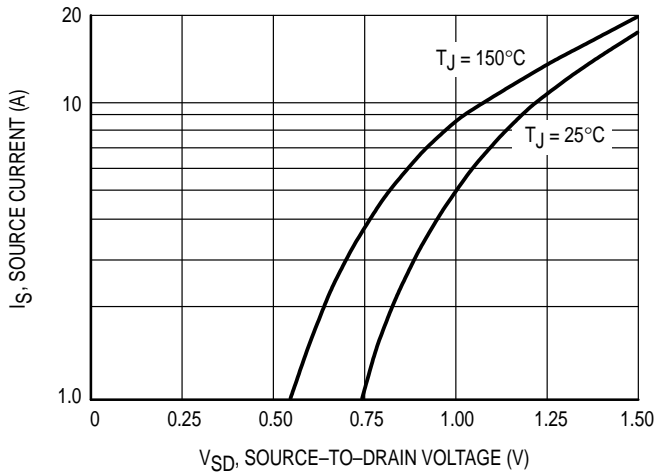

Figure 7. Source-Drain Diode Forward Voltage

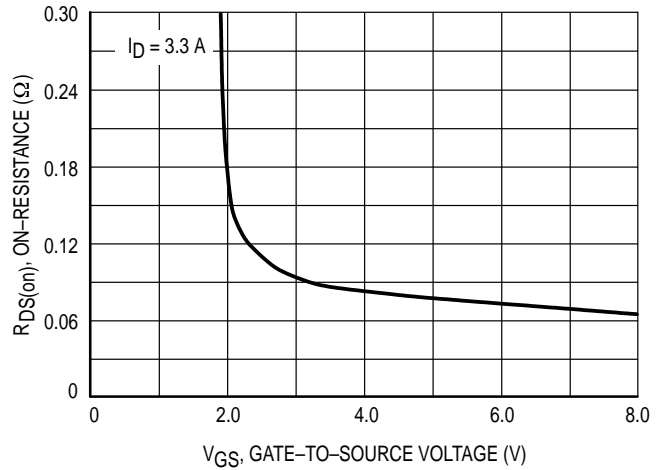

Figure 8. On-Resistance versus Gate-to-Source Voltage

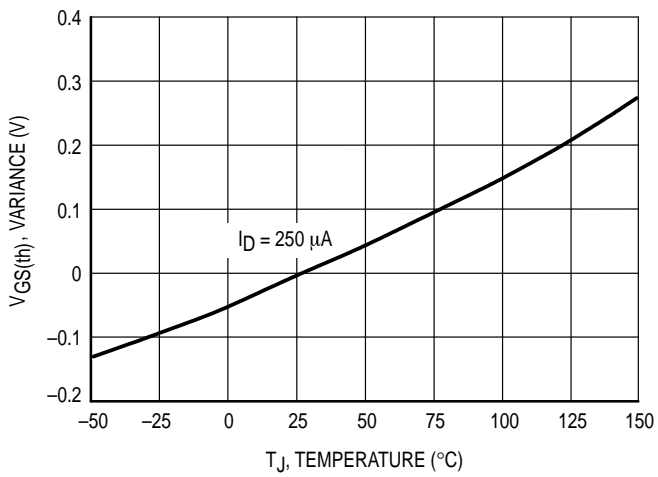

Figure 9. Threshold Voltage

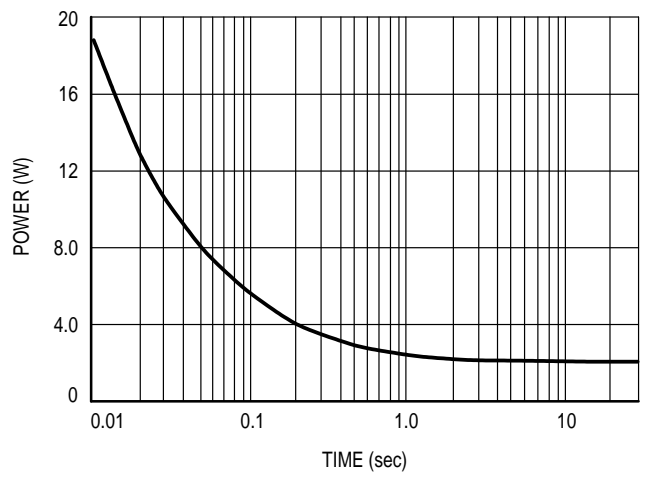

Figure 10. Single Pulse Power

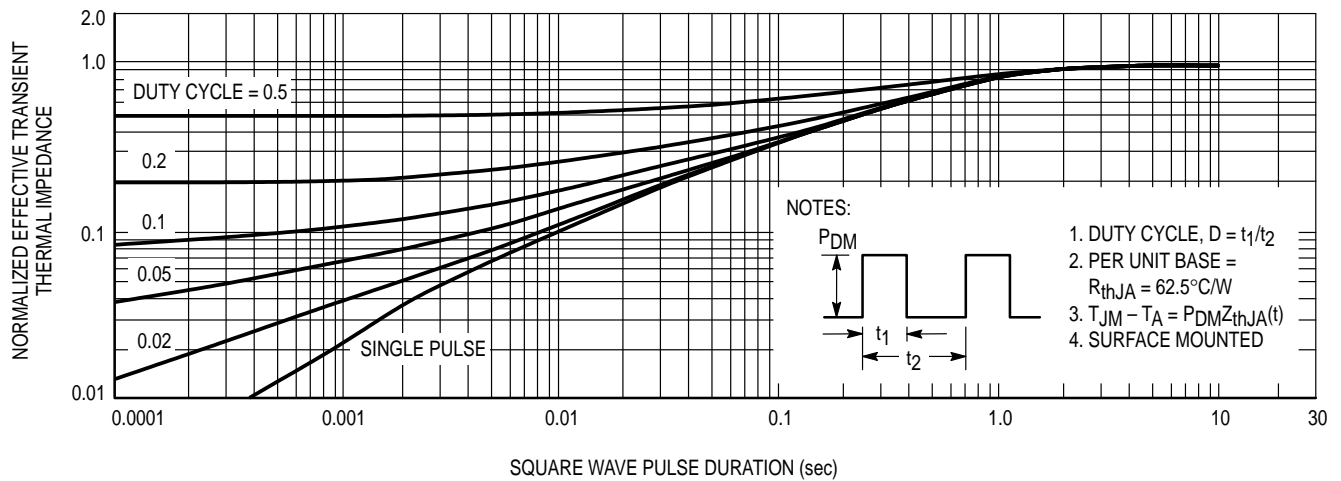

Figure 11. Normalized Thermal Transient Impedance, Junction-to-Ambient

INFORMATION FOR USING THE TSOP-6 SURFACE MOUNT PACKAGE

MINIMUM RECOMMENDED FOOTPRINT FOR SURFACE MOUNTED APPLICATIONS

Surface mount board layout is a critical portion of the total design. The footprint for the semiconductor packages must be the correct size to insure proper solder connection

interface between the board and the package. With the correct pad geometry, the packages will self align when subjected to a solder reflow process.

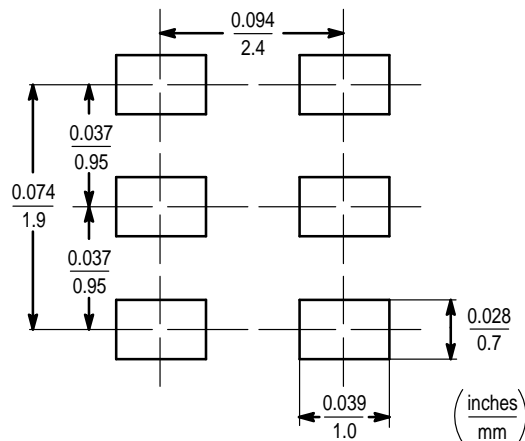

TSOP-6

TSOP-6 POWER DISSIPATION

The power dissipation of the TSOP-6 is a function of the drain pad size. This can vary from the minimum pad size for soldering to a pad size given for maximum power dissipation. Power dissipation for a surface mount device is determined by $T_{J(max)}$, the maximum rated junction temperature of the die, $R_{\theta JA}$, the thermal resistance from the device junction to ambient, and the operating temperature, T_A . Using the values provided on the data sheet for the TSOP-6 package, P_D can be calculated as follows:

$$P_D = \frac{T_{J(max)} - T_A}{R_{\theta JA}}$$

The values for the equation are found in the maximum ratings table on the data sheet. Substituting these values into the equation for an ambient temperature T_A of 25°C, one can calculate the power dissipation of the device which in this case is 2.0 watts.

$$P_D = \frac{150^\circ\text{C} - 25^\circ\text{C}}{128^\circ\text{C/W}} = 2.0 \text{ watts}$$

The 128°C/W for the TSOP-6 package assumes the use of the recommended footprint on a glass epoxy printed circuit board to achieve a power dissipation of 2.0 watts. There are other alternatives to achieving higher power dissipation from the TSOP-6 package. Another alternative would be to use a ceramic substrate or an aluminum core board such as Thermal Clad™. Using a board material such as Thermal Clad, an aluminum core board, the power dissipation can be doubled using the same footprint.

SOLDERING PRECAUTIONS

The melting temperature of solder is higher than the rated temperature of the device. When the entire device is heated to a high temperature, failure to complete soldering within a short time could result in device failure. Therefore, the following items should always be observed in order to minimize the thermal stress to which the devices are subjected.

- Always preheat the device.
- The delta temperature between the preheat and soldering should be 100°C or less.*
- When preheating and soldering, the temperature of the leads and the case must not exceed the maximum temperature ratings as shown on the data sheet. When using infrared heating with the reflow soldering method, the difference shall be a maximum of 10°C.
- The soldering temperature and time shall not exceed 260°C for more than 10 seconds.
- When shifting from preheating to soldering, the maximum temperature gradient shall be 5°C or less.
- After soldering has been completed, the device should be allowed to cool naturally for at least three minutes. Gradual cooling should be used as the use of forced cooling will increase the temperature gradient and result in latent failure due to mechanical stress.
- Mechanical stress or shock should not be applied during cooling.

* Soldering a device without preheating can cause excessive thermal shock and stress which can result in damage to the device.

PACKAGE DIMENSIONS

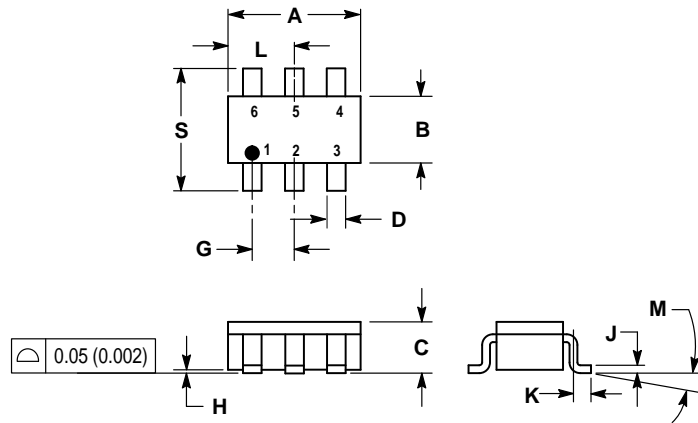

- NOTES:
1. DIMENSIONING AND TOLERANCING PER ANSI Y14.5M, 1982.
 2. CONTROLLING DIMENSION: MILLIMETER.
 3. MAXIMUM LEAD THICKNESS INCLUDES LEAD FINISH THICKNESS. MINIMUM LEAD THICKNESS IS THE MINIMUM THICKNESS OF BASE MATERIAL.

DIM	MILLIMETERS		INCHES	
	MIN	MAX	MIN	MAX
A	2.90	3.10	0.1142	0.1220
B	1.30	1.70	0.0512	0.0669
C	0.90	1.10	0.0354	0.0433
D	0.25	0.50	0.0098	0.0197
G	0.85	1.05	0.0335	0.0413
H	0.013	0.100	0.0005	0.0040
J	0.10	0.26	0.0040	0.0102
K	0.20	0.60	0.0079	0.0236
L	1.25	1.55	0.0493	0.0610
M	0°	10°	0°	10°
S	2.50	3.00	0.0985	0.1181

- STYLE 1:
 PIN 1. DRAIN
 2. DRAIN
 3. GATE
 4. SOURCE
 5. DRAIN
 6. DRAIN

CASE 318G-02
 ISSUE A
 TSOP 6 PLASTIC

Motorola reserves the right to make changes without further notice to any products herein. Motorola makes no warranty, representation or guarantee regarding the suitability of its products for any particular purpose, nor does Motorola assume any liability arising out of the application or use of any product or circuit, and specifically disclaims any and all liability, including without limitation consequential or incidental damages. "Typical" parameters which may be provided in Motorola data sheets and/or specifications can and do vary in different applications and actual performance may vary over time. All operating parameters, including "Typicals" must be validated for each customer application by customer's technical experts. Motorola does not convey any license under its patent rights nor the rights of others. Motorola products are not designed, intended, or authorized for use as components in systems intended for surgical implant into the body, or other applications intended to support or sustain life, or for any other application in which the failure of the Motorola product could create a situation where personal injury or death may occur. Should Buyer purchase or use Motorola products for any such unintended or unauthorized application, Buyer shall indemnify and hold Motorola and its officers, employees, subsidiaries, affiliates, and distributors harmless against all claims, costs, damages, and expenses, and reasonable attorney fees arising out of, directly or indirectly, any claim of personal injury or death associated with such unintended or unauthorized use, even if such claim alleges that Motorola was negligent regarding the design or manufacture of the part. Motorola and are registered trademarks of Motorola, Inc. Motorola, Inc. is an Equal Opportunity/Affirmative Action Employer.

This device has a class 1 ESD rating.

Mfax is a trademark of Motorola, Inc.

How to reach us:

USA/EUROPE/Locations Not Listed: Motorola Literature Distribution;
 P.O. Box 5405, Denver, Colorado 80217. 303-675-2140 or 1-800-441-2447

JAPAN: Nippon Motorola Ltd.; Tatsumi-SPD-JLDC, 6F Seibu-Butsuryu-Center,
 3-14-2 Tatsumi Koto-Ku, Tokyo 135, Japan. 81-3-3521-8315

Mfax™: RMFAX0@email.sps.mot.com - TOUCHTONE 602-244-6609
 - US & Canada ONLY 1-800-774-1848

ASIA/PACIFIC: Motorola Semiconductors H.K. Ltd.; 8B Tai Ping Industrial Park,
 51 Ting Kok Road, Tai Po, N.T., Hong Kong. 852-26629298

INTERNET: <http://www.mot.com/SPS/>

