

# SWITCHMODE™ NPN Bipolar Power Transistor for Electronic Light Ballast and Switching Power Supply Applications

The MJE/MJF18204 have an application specific state-of-the-art die dedicated to the electronic ballast (“light ballast”) and power supply applications.

- Improved Global Efficiency Due to Low Base Drive Requirements:
  - High and Flat DC Current Gain  $h_{FE}$
  - Fast Switching
  - No Coil Required in Base Circuit for Fast Turn-Off (No Current Tail)
- Full Characterization at 125°C
- ON Semiconductor “6 SIGMA” Philosophy Provides Tight and Reproducible Parametric Distributions
- Two Package Choices: Standard TO-220 or Isolated TO-220

## MAXIMUM RATINGS

Rating	Symbol	MJE18204	MJF18204	Unit
Collector-Emitter Voltage	$V_{CEO}$	600		Vdc
Collector-Base Voltage	$V_{CBO}$	1200		Vdc
Collector-Emitter Voltage	$V_{CES}$	1200		Vdc
Emitter-Base Voltage	$V_{EBO}$	10		Vdc
Collector Current — Continuous	$I_C$	5		Adc
— Peak (1)	$I_{CM}$	10		
Base Current — Continuous	$I_B$	2		Adc
— Peak (1)	$I_{BM}$	4		
RMS Isolation Voltage (2) (for 1 sec, R.H. ≤ 30%) $T_C = 25^\circ\text{C}$	$V_{ISOL1}$ $V_{ISOL2}$ $V_{ISOL3}$		4500 3500 1500	Volts
*Total Device Dissipation @ $T_C = 25^\circ\text{C}$ *Derate above 25°C	$P_D$	75 0.6	35 0.28	Watt W/°C
Operating and Storage Temperature	$T_J, T_{stg}$	-65 to 150		°C

## THERMAL CHARACTERISTICS

Rating	Symbol	MJE18204	MJF18204	Unit
Thermal Resistance — Junction to Case	$R_{\theta JC}$	1.65	3.55	°C/W
— Junction to Ambient	$R_{\theta JA}$	62.5	62.5	
Maximum Lead Temperature for Soldering Purposes: 1/8" from Case for 5 Seconds	$T_L$	260		°C

- (1) Pulse Test: Pulse Width = 5 ms, Duty Cycle ≤ 10%.  
 (2) Proper strike and creepage distance must be provided.

**MJE18204**  
**MJF18204**

POWER TRANSISTORS  
5 AMPERES  
1200 VOLTS  
35 and 75 WATTS

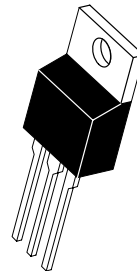
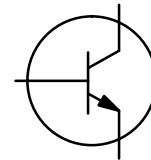

CASE 221A-09  
TO-220AB

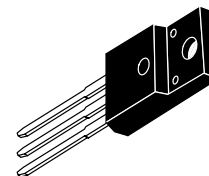

CASE 221D-02  
TO-220 FULLPACK

# MJE18204 MJF18204

## ELECTRICAL CHARACTERISTICS (T<sub>C</sub> = 25°C unless otherwise noted)

Characteristic	Symbol	Min	Typ	Max	Unit
Collector–Emitter Voltage (I <sub>C</sub> = 1 mA, I <sub>B</sub> = 0)	V <sub>CEO</sub>	600	660		Vdc
Collector–Emitter Sustaining Voltage (I <sub>C</sub> = 100 mA, L = 25 mH) (I <sub>C</sub> = 200 mA, L = 25 mH, R = 2 Ω)	V <sub>CEO(sus)</sub> V <sub>CER(sus)</sub>	550 600	630 700		Vdc
Collector–Base Breakdown Voltage (I <sub>CBO</sub> = 1 mA, I <sub>E</sub> = 0)	V <sub>CBO</sub>	1200	1300		Vdc
Emitter–Base Breakdown Voltage (I <sub>EBO</sub> = 1 mA, I <sub>C</sub> = 0)	V <sub>EBO</sub>	10	12.9		Vdc
Collector Cutoff Current (V <sub>CE</sub> = 600 V, I <sub>B</sub> = 0) (V <sub>CE</sub> = 550 V, I <sub>B</sub> = 0)	@ T <sub>C</sub> = 25°C @ T <sub>C</sub> = 125°C	I <sub>CEO</sub>		200 2000	μA <sub>dc</sub>
Collector Cutoff Current (V <sub>CE</sub> = Rated V <sub>CEs</sub> , V <sub>BE</sub> = 0) (V <sub>CE</sub> = 1000 V, V <sub>BE</sub> = 0)	@ T <sub>C</sub> = 25°C @ T <sub>C</sub> = 125°C @ T <sub>C</sub> = 125°C	I <sub>CES</sub>		100 500 100	μA <sub>dc</sub>
Collector Cutoff Current (V <sub>CB</sub> = Rated V <sub>CB</sub> , I <sub>E</sub> = 0)		I <sub>CBO</sub>		100	μA <sub>dc</sub>
Emitter–Cutoff Current (V <sub>EB</sub> = 10 Vdc, I <sub>C</sub> = 0)		I <sub>EBO</sub>		100	μA <sub>dc</sub>

## ON CHARACTERISTICS

Base–Emitter Saturation Voltage (I <sub>C</sub> = 1 Adc, I <sub>B</sub> = 0.1 Adc) (I <sub>C</sub> = 2 Adc, I <sub>B</sub> = 0.4 Adc)		V <sub>BE(sat)</sub>		0.83 0.92	1.1 1.25	Vdc
Collector–Emitter Saturation Voltage (I <sub>C</sub> = 1 Adc, I <sub>B</sub> = 0.1 Adc)  (I <sub>C</sub> = 2 Adc, I <sub>B</sub> = 0.4 Adc)	@ T <sub>C</sub> = 25°C @ T <sub>C</sub> = 125°C  @ T <sub>C</sub> = 25°C @ T <sub>C</sub> = 125°C	V <sub>CE(sat)</sub>		0.3 0.7 0.3 0.8	1 1.25 0.6 1.25	Vdc
DC Current Gain (I <sub>C</sub> = 0.5 Adc, V <sub>CE</sub> = 3 Vdc)  (I <sub>C</sub> = 1 Adc, V <sub>CE</sub> = 1 Vdc)  (I <sub>C</sub> = 2 Adc, V <sub>CE</sub> = 1 Vdc)  (I <sub>C</sub> = 5 mAdc, V <sub>CE</sub> = 5 Vdc)	@ T <sub>C</sub> = 25°C @ T <sub>C</sub> = 125°C  @ T <sub>C</sub> = 25°C @ T <sub>C</sub> = 125°C  @ T <sub>C</sub> = 25°C @ T <sub>C</sub> = 125°C  @ T <sub>C</sub> = 25°C @ T <sub>C</sub> = 125°C	h <sub>FE</sub>	18  10 8 5 4 10	23  13 6 25 33	35  22	—

## DYNAMIC CHARACTERISTICS

Current Gain Bandwidth (I <sub>C</sub> = 0.5 Adc, V <sub>CE</sub> = 10 Vdc, f = 1 MHz)	f <sub>T</sub>		13		MHz
Output Capacitance (V <sub>CB</sub> = 10 Vdc, I <sub>E</sub> = 0, f = 1 MHz)	C <sub>ob</sub>			200	pF
Input Capacitance (V <sub>EB</sub> = 8 Vdc)	C <sub>ib</sub>			2000	pF

## DYNAMIC SATURATION VOLTAGE

Dynamic Saturation Voltage: Determined 1 μs and 3 μs respectively after rising I <sub>B1</sub> reaches 90% of final I <sub>B1</sub>	I <sub>C</sub> = 2 Adc I <sub>B1</sub> = 660 mA <sub>dc</sub> V <sub>CC</sub> = 300 V	@ 3 μs	@ T <sub>C</sub> = 25°C	V <sub>CE(dsat)</sub>	2.5		V
			@ T <sub>C</sub> = 125°C		7.5		
	I <sub>C</sub> = 2 Adc I <sub>B1</sub> = 0.4 Adc V <sub>CC</sub> = 300 V	@ 3 μs	@ T <sub>C</sub> = 25°C		7		
			@ T <sub>C</sub> = 125°C		15		

# MJE18204 MJF18204

## ELECTRICAL CHARACTERISTICS ( $T_C = 25^\circ\text{C}$ unless otherwise noted) continued

Characteristic	Symbol	Min	Typ	Max	Unit
----------------	--------	-----	-----	-----	------

### SWITCHING CHARACTERISTICS: Resistive Load ( $D.C. \leq 10\%$ , Pulse Width = 20 $\mu\text{s}$ )

Turn-on Time	$I_C = 2 \text{ Adc}$ , $I_{B1} = 0.4 \text{ Adc}$ $I_{B2} = 1 \text{ Adc}$ $V_{CC} = 300 \text{ Vdc}$	@ $T_C = 25^\circ\text{C}$	$t_{on}$		105	175	ns
Turn-off Time		@ $T_C = 25^\circ\text{C}$	$t_{off}$		1.75	2.5	$\mu\text{s}$
Turn-on Time	$I_C = 2 \text{ Adc}$ , $I_{B1} = 0.4 \text{ Adc}$ $I_{B2} = 0.4 \text{ Adc}$ $V_{CC} = 300 \text{ Vdc}$	@ $T_C = 25^\circ\text{C}$	$t_{on}$		95	200	ns
Turn-off Time		@ $T_C = 25^\circ\text{C}$	$t_{off}$		3.5	4.5	$\mu\text{s}$
Turn-on Time	$I_C = 0.7 \text{ Adc}$ , $I_{B1} = 50 \text{ mAdc}$ $I_{B2} = 0.4 \text{ Adc}$ $V_{CC} = 125 \text{ Vdc}$ $PW = 70 \mu\text{s}$	@ $T_C = 25^\circ\text{C}$	$t_d$		70	150	ns
			$t_r$		210	400	ns
Turn-off Time		@ $T_C = 25^\circ\text{C}$	$t_s$		0.9	1.2	$\mu\text{s}$
		@ $T_C = 25^\circ\text{C}$	$t_f$		275	450	ns

### SWITCHING CHARACTERISTICS: Inductive Load ( $V_{clamp} = 300 \text{ V}$ , $V_{CC} = 15 \text{ V}$ , $L = 200 \mu\text{H}$ )

Fall Time	$I_C = 1 \text{ Adc}$ $I_{B1} = 0.1 \text{ Adc}$ $I_{B2} = 0.5 \text{ Adc}$	@ $T_C = 25^\circ\text{C}$	$t_f$		110	175	ns
		@ $T_C = 125^\circ\text{C}$			95		
Storage Time		@ $T_C = 25^\circ\text{C}$	$t_s$		1.35	2	$\mu\text{s}$
		@ $T_C = 125^\circ\text{C}$			1.9		
Crossover Time		@ $T_C = 25^\circ\text{C}$	$t_c$		150	250	ns
		@ $T_C = 125^\circ\text{C}$			115		
Fall Time	$I_C = 2 \text{ Adc}$ $I_{B1} = 0.4 \text{ Adc}$ $I_{B2} = 1 \text{ Adc}$	@ $T_C = 25^\circ\text{C}$	$t_f$		120	200	ns
		@ $T_C = 125^\circ\text{C}$			180		
Storage Time		@ $T_C = 25^\circ\text{C}$	$t_s$		1.9	2.75	$\mu\text{s}$
		@ $T_C = 125^\circ\text{C}$			2.35		
Crossover Time		@ $T_C = 25^\circ\text{C}$	$t_c$		190	300	ns
		@ $T_C = 125^\circ\text{C}$			180		
Fall Time	$I_C = 2 \text{ Adc}$ $I_{B1} = 0.4 \text{ Adc}$ $I_{B2} = 0.4 \text{ Adc}$	@ $T_C = 25^\circ\text{C}$	$t_f$		185	300	ns
Storage Time		@ $T_C = 25^\circ\text{C}$	$t_s$		4	5	$\mu\text{s}$
Crossover Time		@ $T_C = 25^\circ\text{C}$	$t_c$		350	500	ns

TYPICAL STATIC CHARACTERISTICS

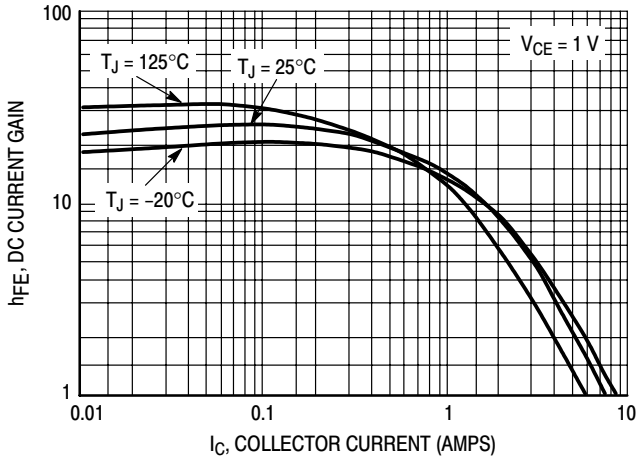

Figure 1. DC Current Gain @ 1 Volt

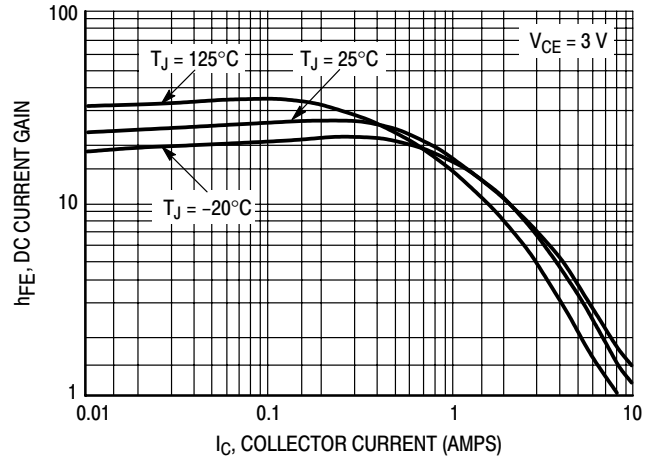

Figure 2. DC Current Gain @ 3 Volts

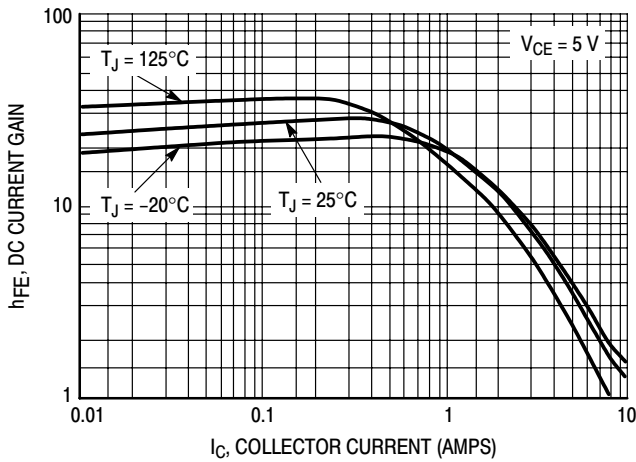

Figure 3. DC Current Gain @ 5 Volts

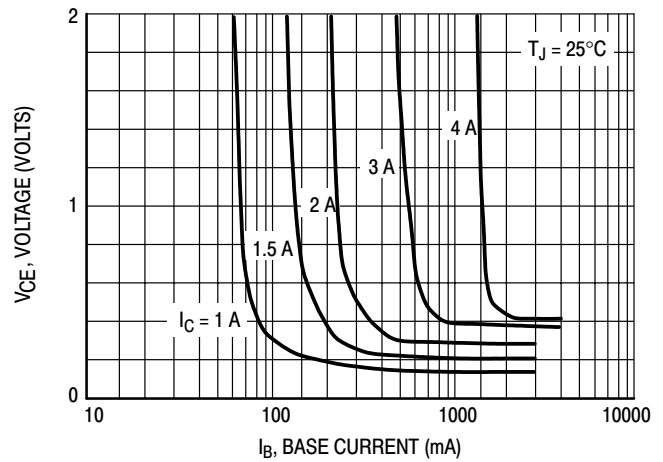

Figure 4. Collector Saturation Region

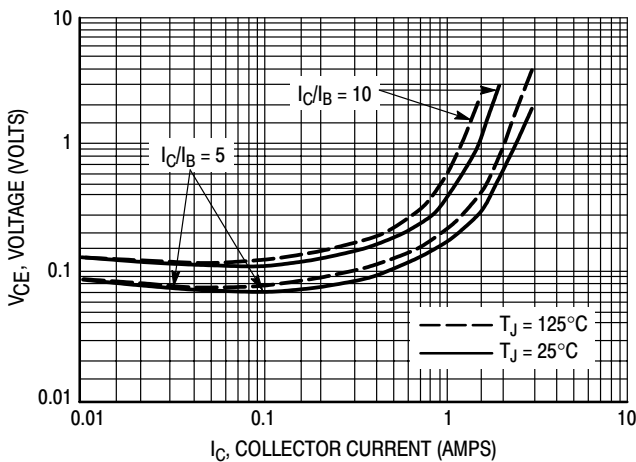

Figure 5. Collector-Emitter Saturation Voltage

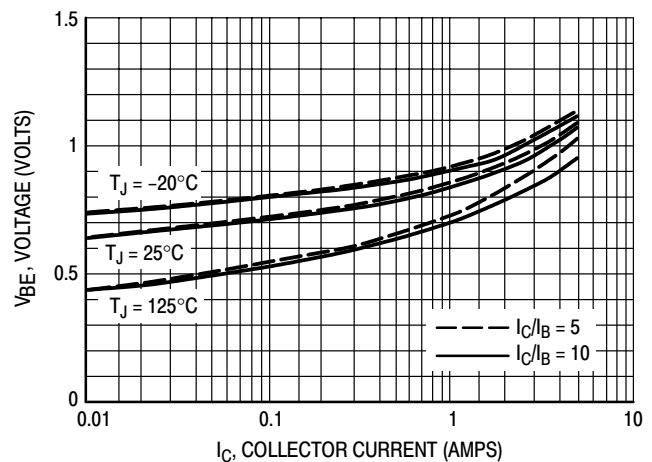

Figure 6. Base-Emitter Saturation Region

TYPICAL STATIC CHARACTERISTICS

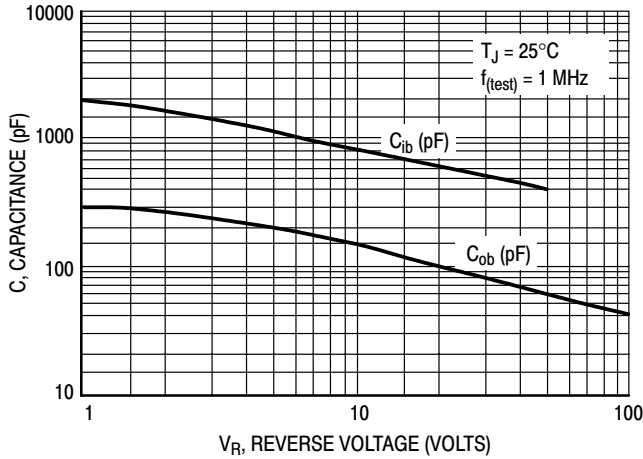

Figure 7. Capacitance

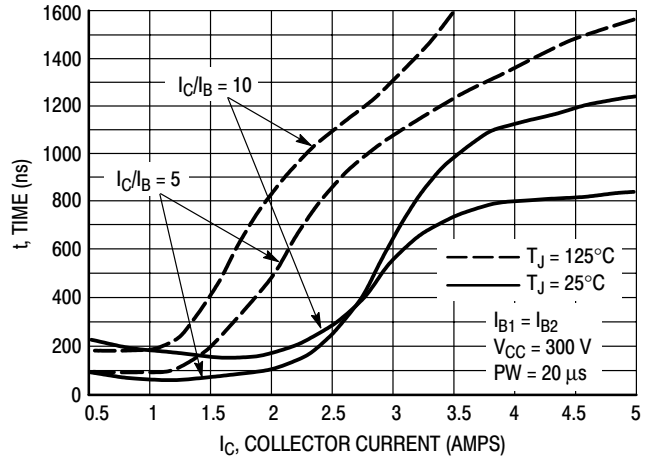

Figure 8. Resistive Switching,  $t_{on}$

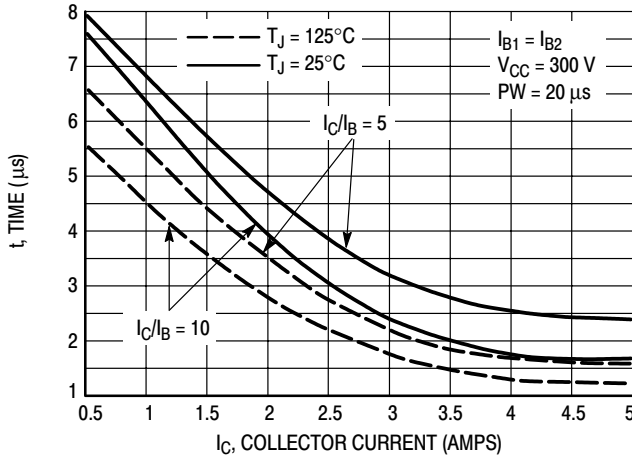

Figure 9. Resistive Switching,  $t_{off}$

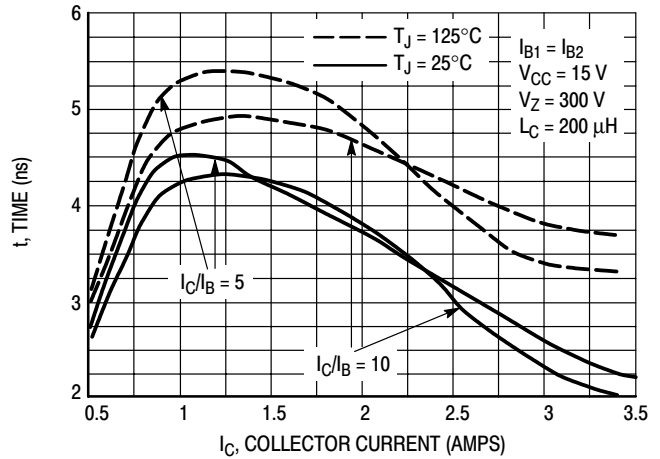

Figure 10. Inductive Storage Time,  $t_{si}$

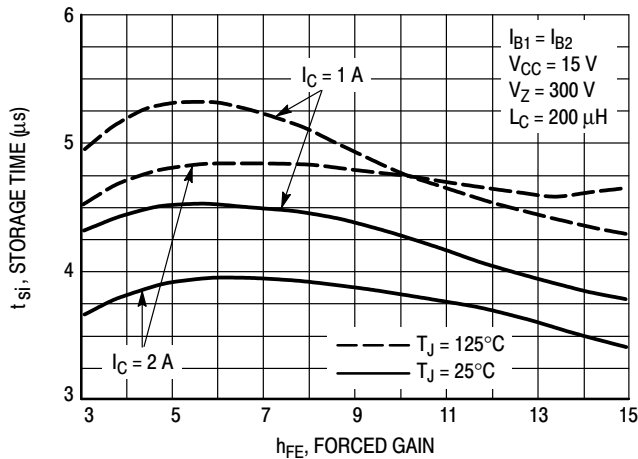

Figure 11. Inductive Storage Time,  $t_{si}$  ( $h_{FE}$ )

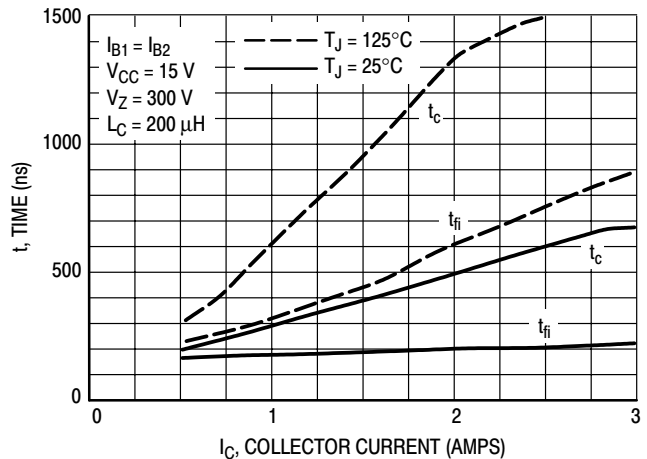

Figure 12. Inductive Switching,  $t_c$  and  $t_{fi}$  @  $I_C/I_B = 5$

TYPICAL STATIC CHARACTERISTICS

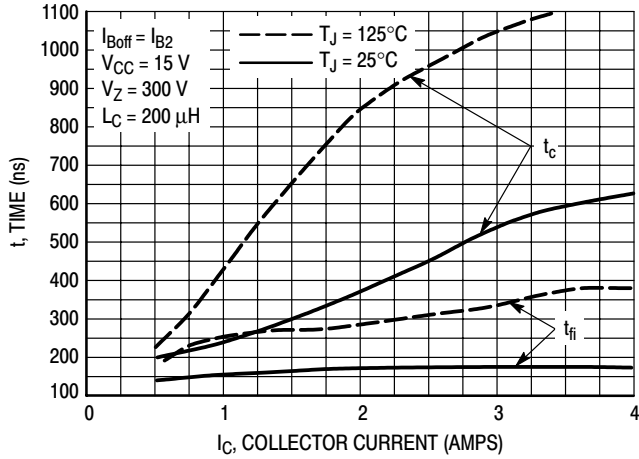

Figure 13. Inductive Switching,  $t_c$  and  $t_{fi}$  @  $I_C/I_B = 10$

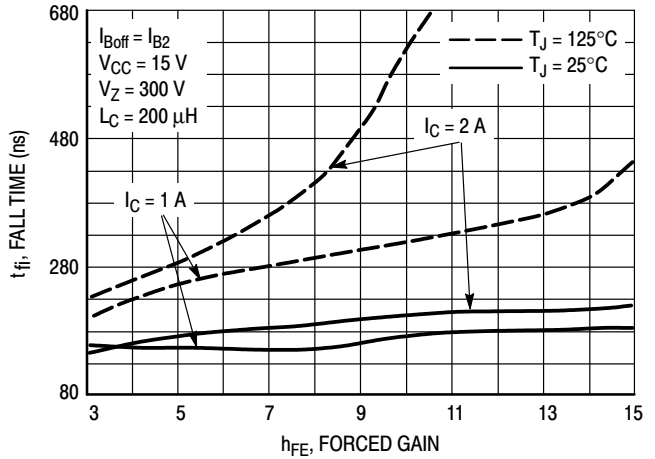

Figure 14. Inductive Fall Time

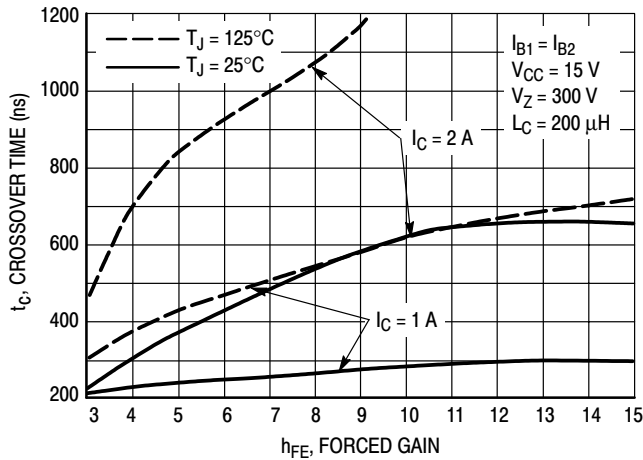

Figure 15. Inductive Crossover Time

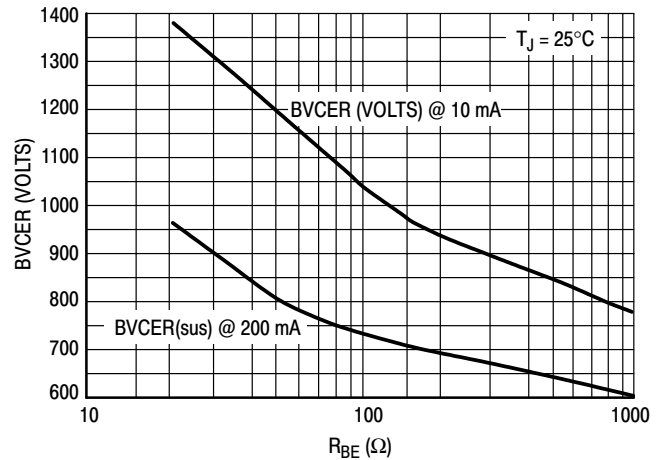

Figure 16.  $BVCER = f(R_{BE})$

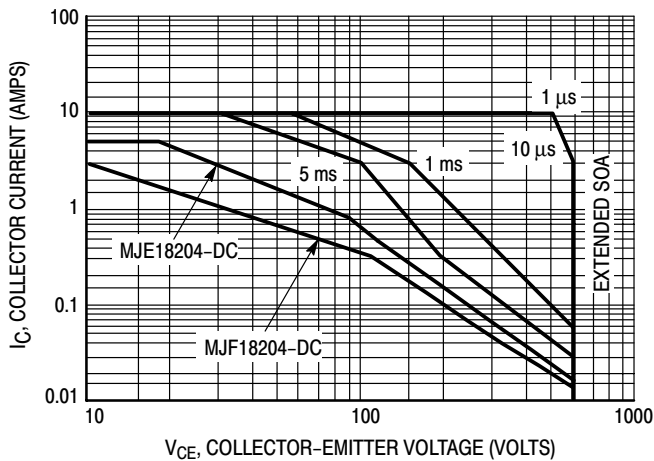

Figure 17. Forward Bias Safe Operating Area

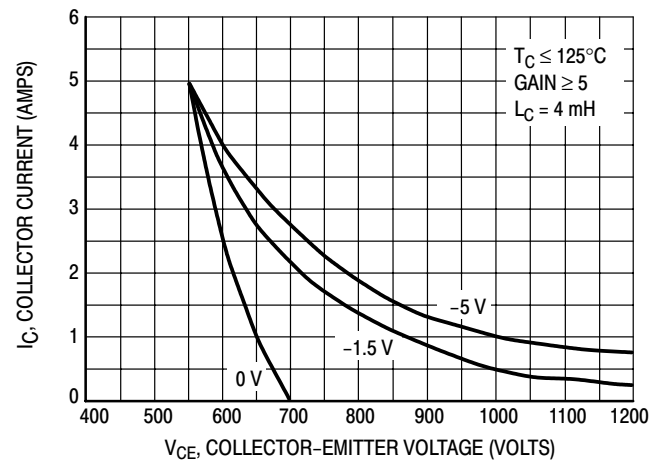

Figure 18. Reverse Bias Switching Safe Operating Area

TYPICAL STATIC CHARACTERISTICS

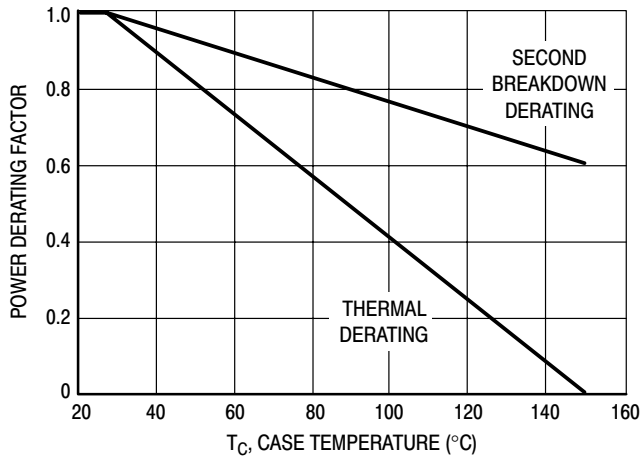

Figure 19. Forward Bias Power Derating

There are two limitations on the power handling ability of a transistor: average junction temperature and second breakdown. Safe operating area curves indicate  $I_C$ - $V_{CE}$  limits of the transistor that must be observed for reliable operation; i.e., the transistor must not be subjected to greater dissipation than the curves indicate. The data of Figure 19 is based on  $T_C = 25^\circ\text{C}$ ;  $T_J(\text{pk})$  is variable depending on power level. Second breakdown pulse limits are valid for duty cycles to 10% but must be derated when  $T_C > 25^\circ\text{C}$ . Second breakdown limitations do not derate the same as thermal limitations. Allowable current at the voltages shown on Figure 16 may be found at any case temperature by using the appropriate curve on Figure 18.

$T_J(\text{pk})$  may be calculated from the data in Figures 21 and 22. At any case temperatures, thermal limitations will reduce the power that can be handled to values less than the limitations imposed by second breakdown. For inductive loads, high voltage and current must be sustained simultaneously during turn-off with the base-to-emitter junction reverse biased. The safe level is specified as a reverse-biased safe operating area (Figure 17). This rating is verified under clamped conditions so that the device is never subjected to an avalanche mode.

TYPICAL SWITCHING CHARACTERISTICS  
( $I_{B1} = I_{B2}$  FOR ALL CURVES)

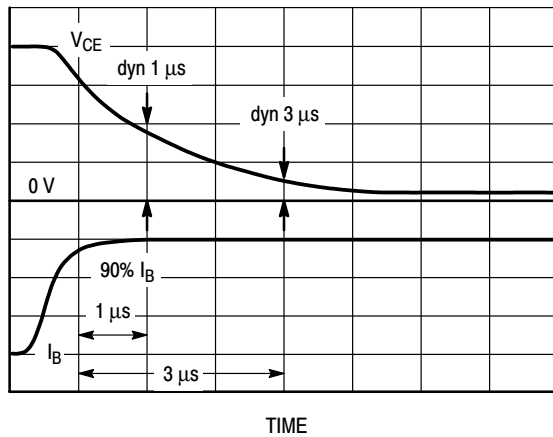

Figure 20. Dynamic Saturation Voltage Measurements

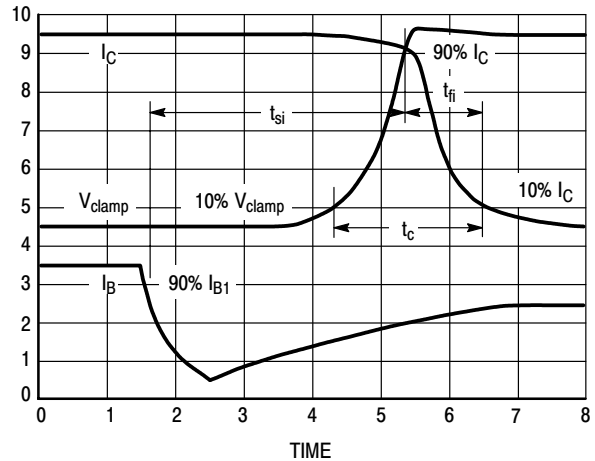
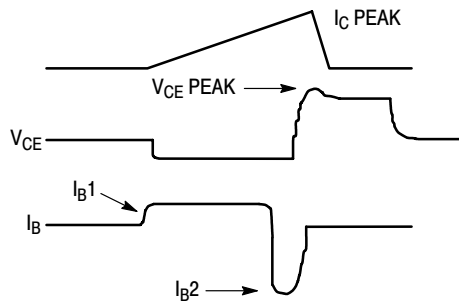
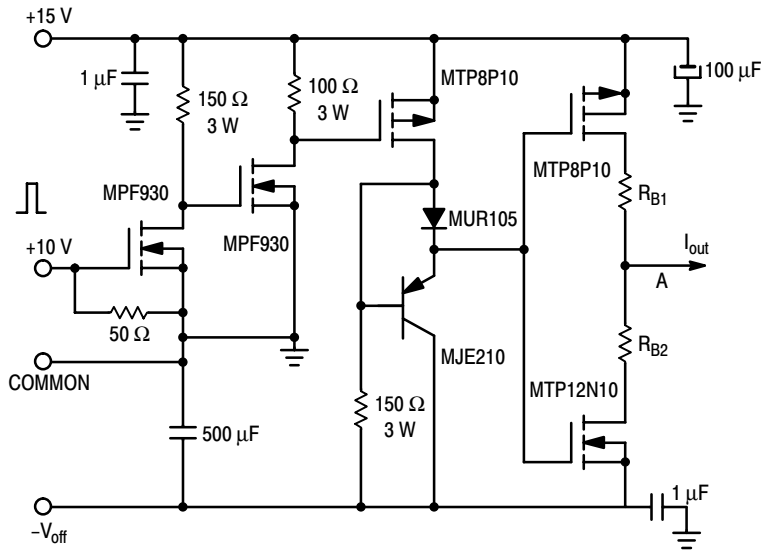

Figure 21. Inductive Switching Measurements

# MJE18204 MJF18204

## TYPICAL SWITCHING CHARACTERISTICS ( $I_{B1} = I_{B2}$ FOR ALL CURVES)

Table 1. Inductive Load Switching Drive Circuit



**$V_{(BR)CEO(sus)}$**   
 $L = 10 \text{ mH}$   
 $R_{B2} = \infty$   
 $V_{CC} = 20 \text{ Volts}$   
 $I_{C(pk)} = 100 \text{ mA}$

**Inductive Switching**  
 $L = 200 \mu\text{H}$   
 $R_{B2} = 0$   
 $V_{CC} = 15 \text{ Volts}$   
 $R_{B1}$  selected for desired  $I_{B1}$

**RBSOA**  
 $L = 500 \mu\text{H}$   
 $R_{B2} = 0$   
 $V_{CC} = 15 \text{ Volts}$   
 $R_{B1}$  selected for desired  $I_{B1}$



# MJE18204 MJF18204

## TYPICAL THERMAL RESPONSE ( $I_{B1} = I_{B2}$ FOR ALL CURVES)

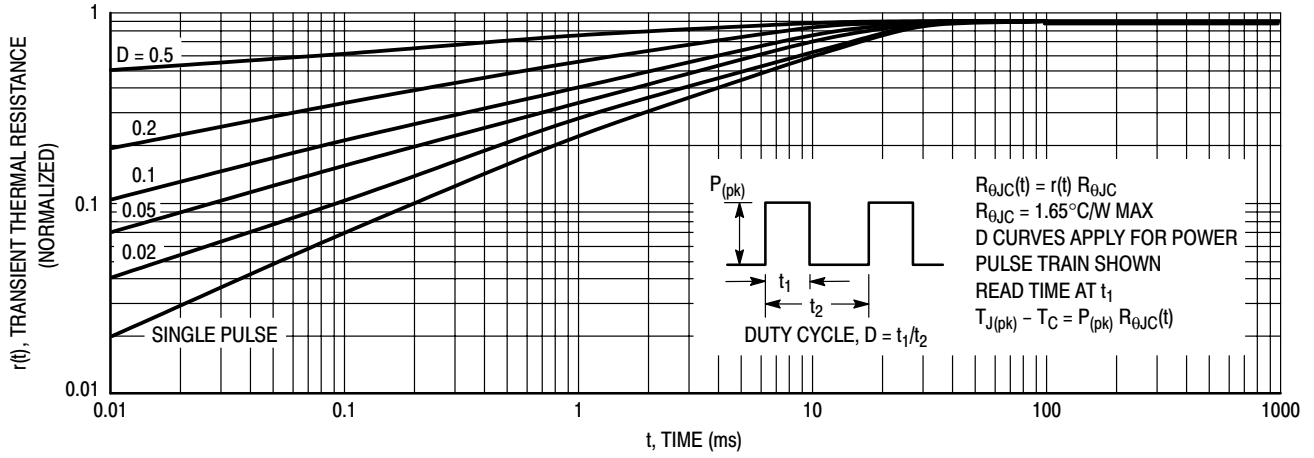

Figure 22. Typical Thermal Response ( $Z_{\theta_{JC}}(t)$ ) for MJE18204

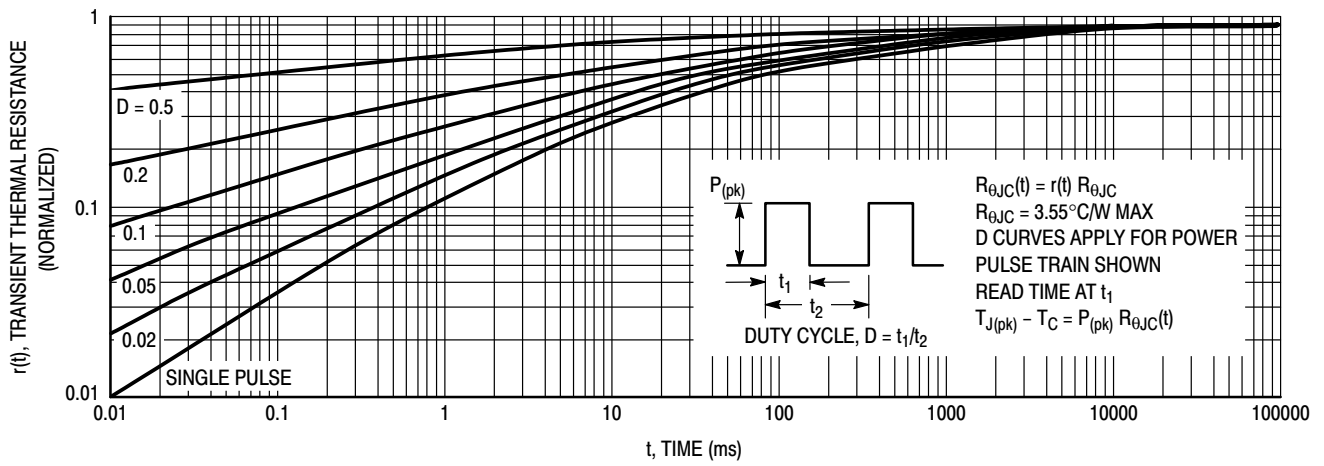

Figure 23. Typical Thermal Response ( $Z_{\theta_{JC}}(t)$ ) for MJF18204

TEST CONDITIONS FOR ISOLATION TESTS\*

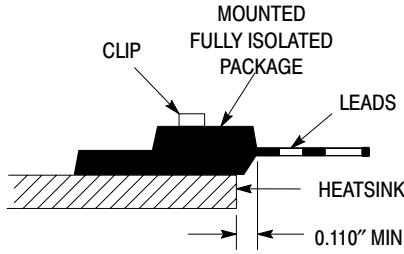

Figure 24. Screw or Clip Mounting Position for Isolation Test Number 1

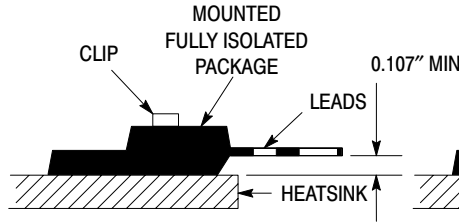

Figure 25. Clip Mounting Position for Isolation Test Number 2

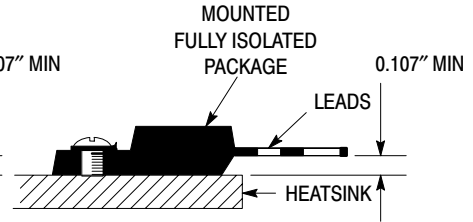

Figure 26. Screw Mounting Position for Isolation Test Number 3

\*Measurement made between leads and heatsink with all leads shorted together

MOUNTING INFORMATION\*\*

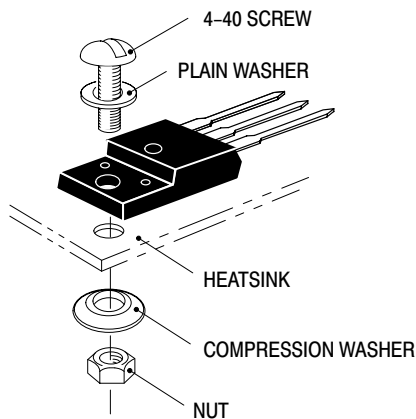

Figure 27a. Screw-Mounted

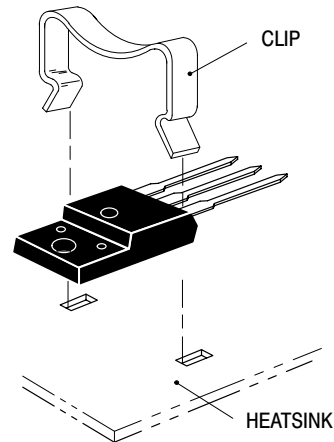

Figure 27b. Clip-Mounted

Figure 27. Typical Mounting Techniques for Isolated Package

Laboratory tests on a limited number of samples indicate, when using the screw and compression washer mounting technique, a screw torque of 6 to 8 in · lbs is sufficient to provide maximum power dissipation capability. The compression washer helps to maintain a constant pressure on the package over time and during large temperature excursions.

Destructive laboratory tests show that using a hex head 4-40 screw, without washers, and applying a torque in excess of 20 in · lbs will cause the plastic to crack around the mounting hole, resulting in a loss of isolation capability.

Additional tests on slotted 4-40 screws indicate that the screw slot fails between 15 to 20 in · lbs without adversely affecting the package. However, in order to positively ensure the package integrity of the fully isolated device, ON Semiconductor does not recommend exceeding 10 in · lbs of mounting torque under any mounting conditions.

\*\* For more information about mounting power semiconductors see Application Note AN1040.

# MJE18204 MJF18204

## PACKAGE DIMENSIONS TO-220AB CASE 221A-09 ISSUE AA

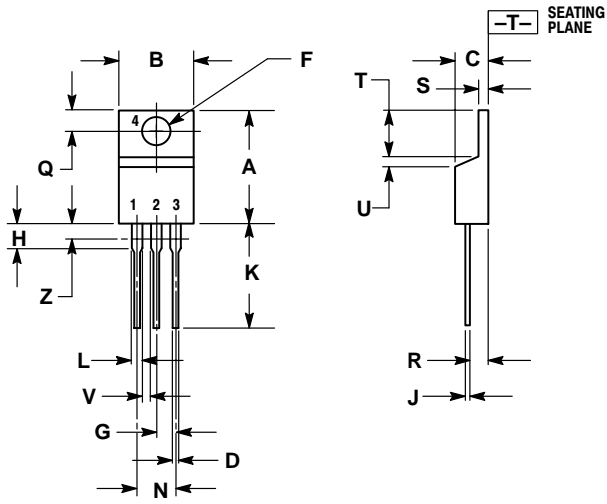

- NOTES:
1. DIMENSIONING AND TOLERANCING PER ANSI Y14.5M, 1982.
  2. CONTROLLING DIMENSION: INCH.
  3. DIMENSION Z DEFINES A ZONE WHERE ALL BODY AND LEAD IRREGULARITIES ARE ALLOWED.

DIM	INCHES		MILLIMETERS	
	MIN	MAX	MIN	MAX
A	0.570	0.620	14.48	15.75
B	0.380	0.405	9.66	10.28
C	0.160	0.190	4.07	4.82
D	0.025	0.035	0.64	0.88
F	0.142	0.147	3.61	3.73
G	0.095	0.105	2.42	2.66
H	0.110	0.155	2.80	3.93
J	0.018	0.025	0.46	0.64
K	0.500	0.562	12.70	14.27
L	0.045	0.060	1.15	1.52
N	0.190	0.210	4.83	5.33
Q	0.100	0.120	2.54	3.04
R	0.080	0.110	2.04	2.79
S	0.045	0.055	1.15	1.39
T	0.235	0.255	5.97	6.47
U	0.000	0.050	0.00	1.27
V	0.045	---	1.15	---
Z	---	0.080	---	2.04

# MJE18204 MJF18204

## PACKAGE DIMENSIONS CASE 221D-02 (ISOLATED TO-220 TYPE) UL RECOGNIZED: FILE #E69369 ISSUE D

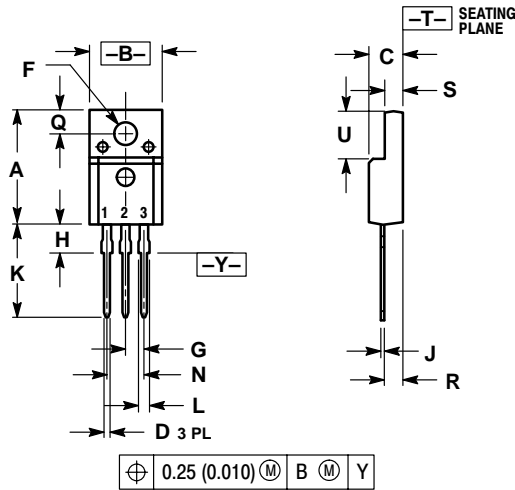

- NOTES:  
1. DIMENSIONING AND TOLERANCING PER ANSI Y14.5M, 1982.  
2. CONTROLLING DIMENSION: INCH.

DIM	INCHES		MILLIMETERS	
	MIN	MAX	MIN	MAX
A	0.621	0.629	15.78	15.97
B	0.394	0.402	10.01	10.21
C	0.181	0.189	4.60	4.80
D	0.026	0.034	0.67	0.86
F	0.121	0.129	3.08	3.27
G	0.100 BSC		2.54 BSC	
H	0.123	0.129	3.13	3.27
J	0.018	0.025	0.46	0.64
K	0.500	0.562	12.70	14.27
L	0.045	0.060	1.14	1.52
N	0.200 BSC		5.08 BSC	
Q	0.126	0.134	3.21	3.40
R	0.107	0.111	2.72	2.81
S	0.096	0.104	2.44	2.64
U	0.259	0.267	6.58	6.78

- STYLE 1:  
PIN 1. GATE  
2. DRAIN  
3. SOURCE

SWITCHMODE is a trademark of Semiconductor Components Industries, LLC.

**ON Semiconductor** and  are trademarks of Semiconductor Components Industries, LLC (SCILLC). SCILLC reserves the right to make changes without further notice to any products herein. SCILLC makes no warranty, representation or guarantee regarding the suitability of its products for any particular purpose, nor does SCILLC assume any liability arising out of the application or use of any product or circuit, and specifically disclaims any and all liability, including without limitation special, consequential or incidental damages. "Typical" parameters which may be provided in SCILLC data sheets and/or specifications can and do vary in different applications and actual performance may vary over time. All operating parameters, including "Typicals" must be validated for each customer application by customer's technical experts. SCILLC does not convey any license under its patent rights nor the rights of others. SCILLC products are not designed, intended, or authorized for use as components in systems intended for surgical implant into the body, or other applications intended to support or sustain life, or for any other application in which the failure of the SCILLC product could create a situation where personal injury or death may occur. Should Buyer purchase or use SCILLC products for any such unintended or unauthorized application, Buyer shall indemnify and hold SCILLC and its officers, employees, subsidiaries, affiliates, and distributors harmless against all claims, costs, damages, and expenses, and reasonable attorney fees arising out of, directly or indirectly, any claim of personal injury or death associated with such unintended or unauthorized use, even if such claim alleges that SCILLC was negligent regarding the design or manufacture of the part. SCILLC is an Equal Opportunity/Affirmative Action Employer.

### PUBLICATION ORDERING INFORMATION

#### NORTH AMERICA Literature Fulfillment:

Literature Distribution Center for ON Semiconductor  
P.O. Box 5163, Denver, Colorado 80217 USA  
**Phone:** 303-675-2175 or 800-344-3860 Toll Free USA/Canada  
**Fax:** 303-675-2176 or 800-344-3867 Toll Free USA/Canada  
**Email:** ONlit@hibbertco.com  
Fax Response Line: 303-675-2167 or 800-344-3810 Toll Free USA/Canada

#### N. American Technical Support: 800-282-9855 Toll Free USA/Canada

#### EUROPE: LDC for ON Semiconductor – European Support

**German Phone:** (+1) 303-308-7140 (Mon-Fri 2:30pm to 7:00pm CET)  
**Email:** ONlit-german@hibbertco.com  
**French Phone:** (+1) 303-308-7141 (Mon-Fri 2:00pm to 7:00pm CET)  
**Email:** ONlit-french@hibbertco.com  
**English Phone:** (+1) 303-308-7142 (Mon-Fri 12:00pm to 5:00pm GMT)  
**Email:** ONlit@hibbertco.com

#### EUROPEAN TOLL-FREE ACCESS\*: 00-800-4422-3781

\*Available from Germany, France, Italy, UK, Ireland

#### CENTRAL/SOUTH AMERICA:

**Spanish Phone:** 303-308-7143 (Mon-Fri 8:00am to 5:00pm MST)  
**Email:** ONlit-spanish@hibbertco.com  
**Toll-Free from Mexico:** Dial 01-800-288-2872 for Access –  
then Dial 866-297-9322

#### ASIA/PACIFIC: LDC for ON Semiconductor – Asia Support

**Phone:** 1-303-675-2121 (Tue-Fri 9:00am to 1:00pm, Hong Kong Time)  
**Toll Free from Hong Kong & Singapore:**  
**001-800-4422-3781**  
**Email:** ONlit-asia@hibbertco.com

#### JAPAN: ON Semiconductor, Japan Customer Focus Center

4-32-1 Nishi-Gotanda, Shinagawa-ku, Tokyo, Japan 141-0031  
**Phone:** 81-3-5740-2700  
**Email:** r14525@onsemi.com

#### ON Semiconductor Website: <http://onsemi.com>

For additional information, please contact your local Sales Representative.