

MMBT2222AWT1

Preferred Device

General Purpose Transistor

NPN Silicon

These transistors are designed for general purpose amplifier applications. They are housed in the SOT-323/SC-70 package which is designed for low power surface mount applications.

MAXIMUM RATINGS

Rating	Symbol	Value	Unit
Collector–Emitter Voltage	V_{CEO}	40	Vdc
Collector–Base Voltage	V_{CBO}	75	Vdc
Emitter–Base Voltage	V_{EBO}	6.0	Vdc
Collector Current – Continuous	I_C	600	mAdc

THERMAL CHARACTERISTICS

Characteristic	Symbol	Max	Unit
Total Device Dissipation FR–5 Board $T_A = 25^\circ\text{C}$	P_D	150	mW
Thermal Resistance Junction–to–Ambient	$R_{\theta JA}$	833	$^\circ\text{C/W}$
Junction and Storage Temperature	T_J, T_{stg}	–55 to +150	$^\circ\text{C}$

Maximum ratings are those values beyond which device damage can occur. Maximum ratings applied to the device are individual stress limit values (not normal operating conditions) and are not valid simultaneously. If these limits are exceeded, device functional operation is not implied, damage may occur and reliability may be affected.



ON Semiconductor®

<http://onsemi.com>

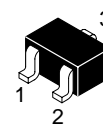
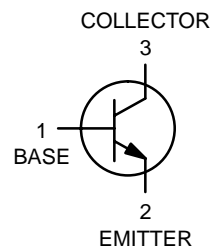

SC-70
CASE 419
STYLE 3

MARKING DIAGRAM

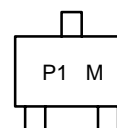

P1 = Specific Device Code
M = Date Code

ORDERING INFORMATION

Device	Package	Shipping†
MMBT2222AWT1	SC-70	3000/Tape & Reel

†For information on tape and reel specifications, including part orientation and tape sizes, please refer to our Tape and Reel Packaging Specification Brochure, BRD8011/D.

Preferred devices are recommended choices for future use and best overall value.

MMBT2222AWT1

ELECTRICAL CHARACTERISTICS ($T_A = 25^\circ\text{C}$ unless otherwise noted)

Characteristic	Symbol	Min	Max	Unit
OFF CHARACTERISTICS				
Collector–Emitter Breakdown Voltage (Note 1) ($I_C = 1.0\text{ mAdc}$, $I_B = 0$)	$V_{(BR)CEO}$	40	–	Vdc
Collector–Base Breakdown Voltage ($I_C = 10\text{ }\mu\text{Adc}$, $I_E = 0$)	$V_{(BR)CBO}$	75	–	Vdc
Emitter–Base Breakdown Voltage ($I_E = 10\text{ }\mu\text{Adc}$, $I_C = 0$)	$V_{(BR)EBO}$	6.0	–	Vdc
Base Cutoff Current ($V_{CE} = 60\text{ Vdc}$, $V_{EB} = 3.0\text{ Vdc}$)	I_{BL}	–	20	nAdc
Collector Cutoff Current ($V_{CE} = 60\text{ Vdc}$, $V_{EB} = 3.0\text{ Vdc}$)	I_{CEX}	–	10	nAdc

ON CHARACTERISTICS (Note 1)

DC Current Gain (Note 1) ($I_C = 0.1\text{ mAdc}$, $V_{CE} = 10\text{ Vdc}$) ($I_C = 1.0\text{ mAdc}$, $V_{CE} = 10\text{ Vdc}$) ($I_C = 10\text{ mAdc}$, $V_{CE} = 10\text{ Vdc}$) ($I_C = 150\text{ mAdc}$, $V_{CE} = 10\text{ Vdc}$) ($I_C = 500\text{ mAdc}$, $V_{CE} = 10\text{ Vdc}$)	H_{FE}	35 50 75 100 40	– – – 300 –	–
Collector–Emitter Saturation Voltage (Note 1) ($I_C = 150\text{ mAdc}$, $I_B = 15\text{ mAdc}$) ($I_C = 500\text{ mAdc}$, $I_B = 50\text{ mAdc}$)	$V_{CE(sat)}$	– –	0.3 1.0	Vdc
Base–Emitter Saturation Voltage (Note 1) ($I_C = 150\text{ mAdc}$, $I_B = 15\text{ mAdc}$) ($I_C = 500\text{ mAdc}$, $I_B = 50\text{ mAdc}$)	$V_{BE(sat)}$	0.6 –	1.2 2.0	Vdc

SMALL–SIGNAL CHARACTERISTICS

Current–Gain – Bandwidth Product ($I_C = 20\text{ mAdc}$, $V_{CE} = 20\text{ Vdc}$, $f = 100\text{ MHz}$)	f_T	300	–	MHz
Output Capacitance ($V_{CB} = 10\text{ Vdc}$, $I_E = 0$, $f = 1.0\text{ MHz}$)	C_{obo}	–	8.0	pF
Input Capacitance ($V_{EB} = 0.5\text{ Vdc}$, $I_C = 0$, $f = 1.0\text{ MHz}$)	C_{ibo}	–	30	pF
Input Impedance ($V_{CE} = 10\text{ Vdc}$, $I_C = 10\text{ mAdc}$, $f = 1.0\text{ kHz}$)	h_{ie}	0.25	1.25	k ohms
Voltage Feedback Ratio ($V_{CE} = 10\text{ Vdc}$, $I_C = 10\text{ mAdc}$, $f = 1.0\text{ kHz}$)	h_{re}	–	4.0	$\times 10^{-4}$
Small–Signal Current Gain ($V_{CE} = 10\text{ Vdc}$, $I_C = 10\text{ mAdc}$, $f = 1.0\text{ kHz}$)	h_{fe}	75	375	–
Output Admittance ($V_{CE} = 10\text{ Vdc}$, $I_C = 10\text{ mAdc}$, $f = 1.0\text{ kHz}$)	h_{oe}	25	200	μmhos
Noise Figure ($V_{CE} = 10\text{ Vdc}$, $I_C = 100\text{ }\mu\text{Adc}$, $R_S = 1.0\text{ k}\Omega$, $f = 1.0\text{ kHz}$)	NF	–	4.0	dB

SWITCHING CHARACTERISTICS

Delay Time	$(V_{CC} = 3.0\text{ Vdc}$, $V_{BE} = -0.5\text{ Vdc}$, $I_C = 150\text{ mAdc}$, $I_{B1} = 15\text{ mAdc}$)	t_d	–	10	ns
Rise Time		t_r	–	25	
Storage Time	$(V_{CC} = 30\text{ Vdc}$, $I_C = 150\text{ mAdc}$, $I_{B1} = I_{B2} = 15\text{ mAdc}$)	t_s	–	225	ns
Fall Time		t_f	–	60	

1. Pulse Test: Pulse Width $\leq 300\text{ }\mu\text{s}$, Duty Cycle $\leq 2.0\%$.

MMBT2222AWT1

SWITCHING TIME EQUIVALENT TEST CIRCUITS

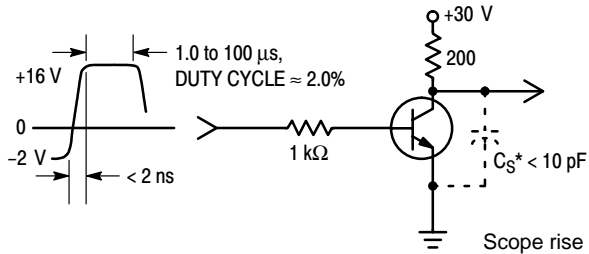

Figure 1. Turn-On Time

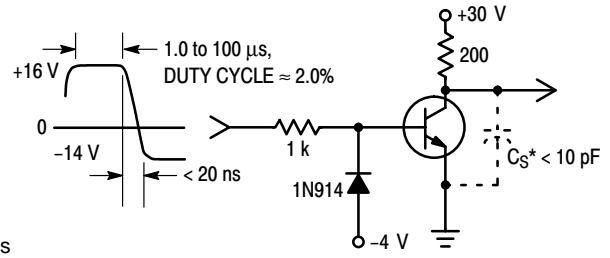

Figure 2. Turn-Off Time

Scope rise time $< 4 \text{ ns}$
 *Total shunt capacitance of test jig, connectors, and oscilloscope.

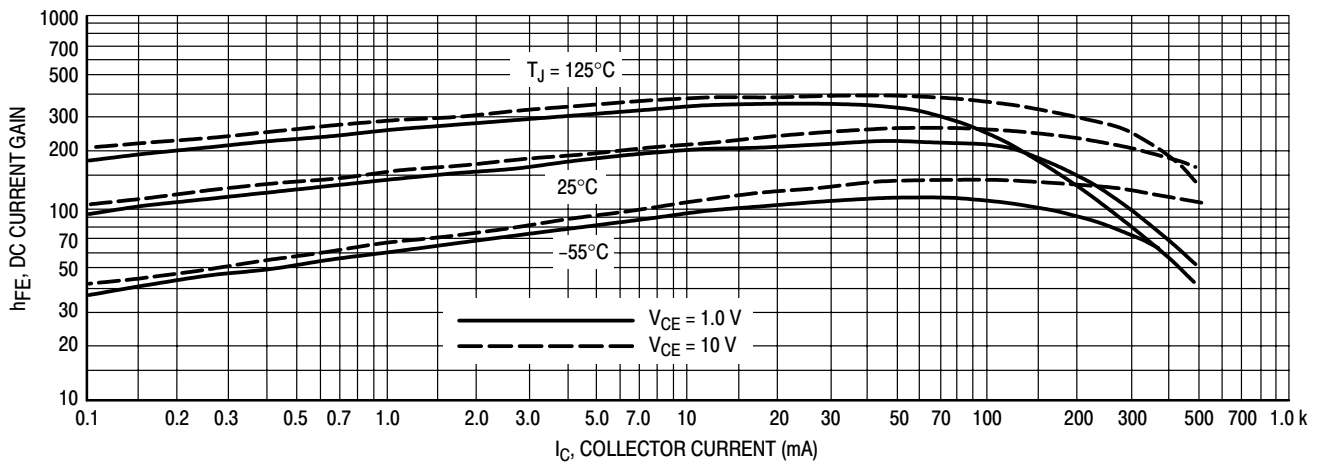

Figure 3. DC Current Gain

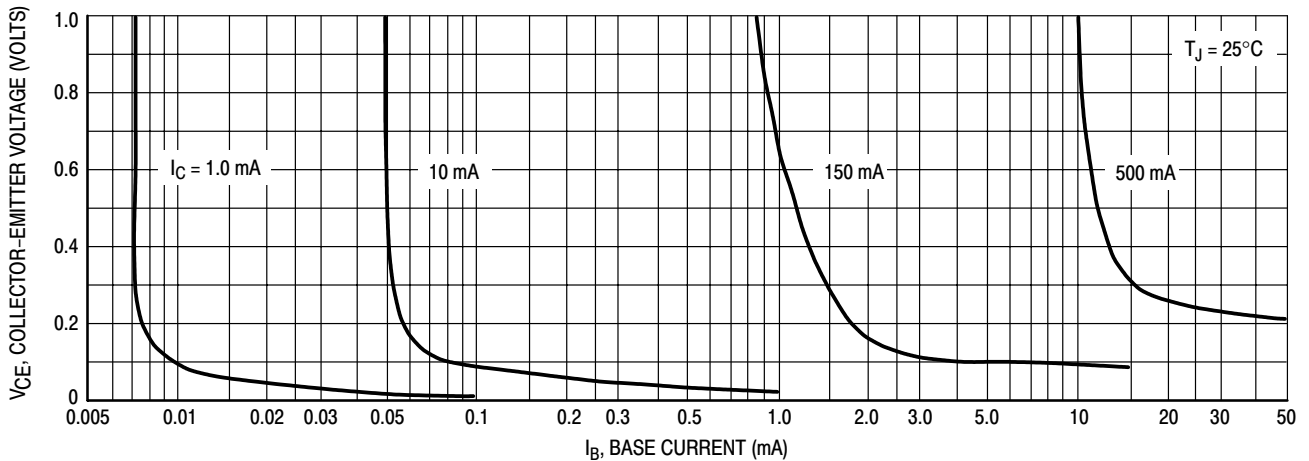

Figure 4. Collector Saturation Region

MMBT2222AWT1

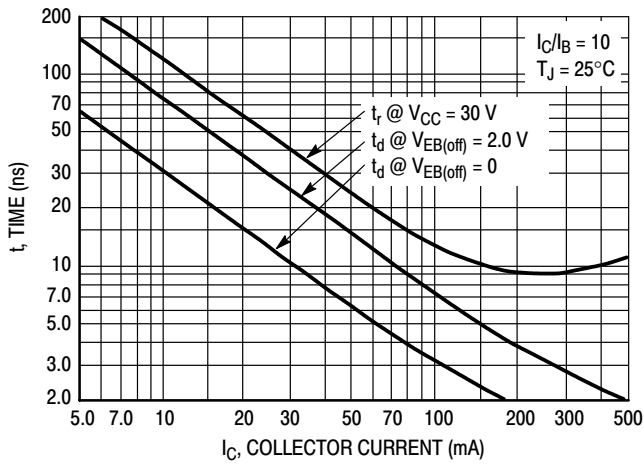

Figure 5. Turn-On Time

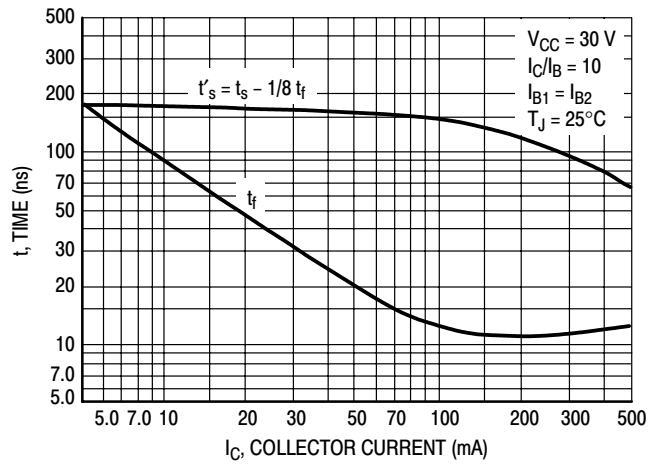

Figure 6. Turn-Off Time

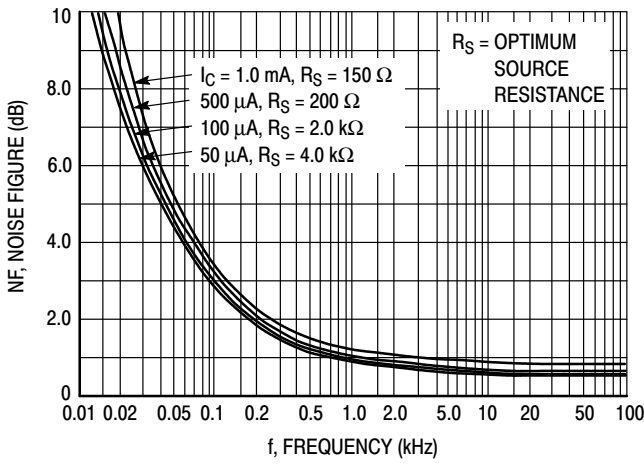

Figure 7. Frequency Effects

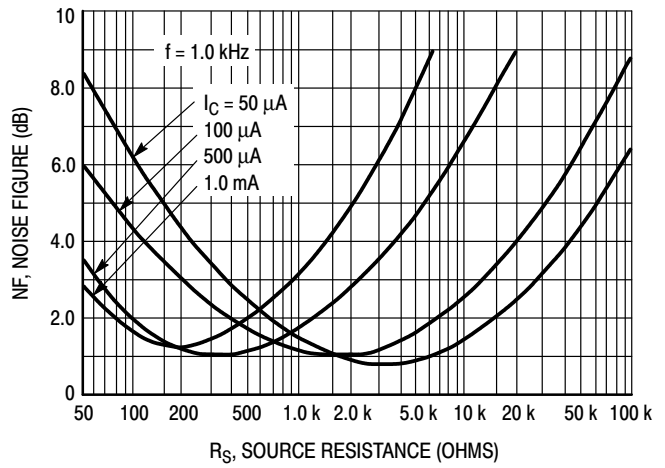

Figure 8. Source Resistance Effects

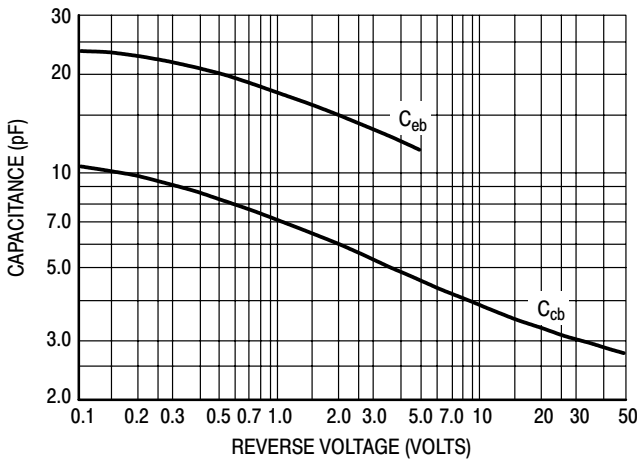

Figure 9. Capacitances

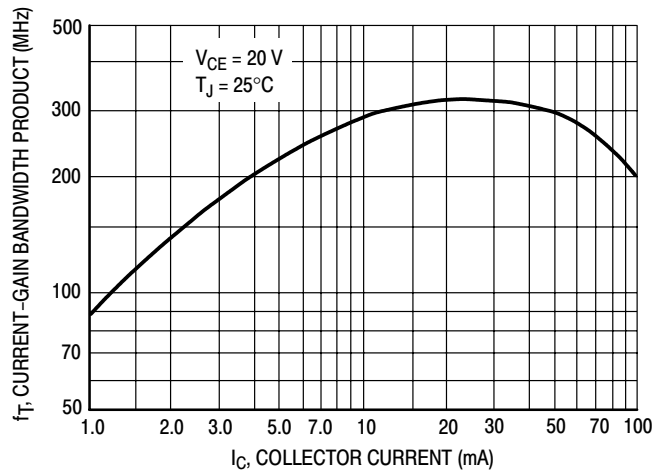

Figure 10. Current-Gain Bandwidth Product

MMBT2222AWT1

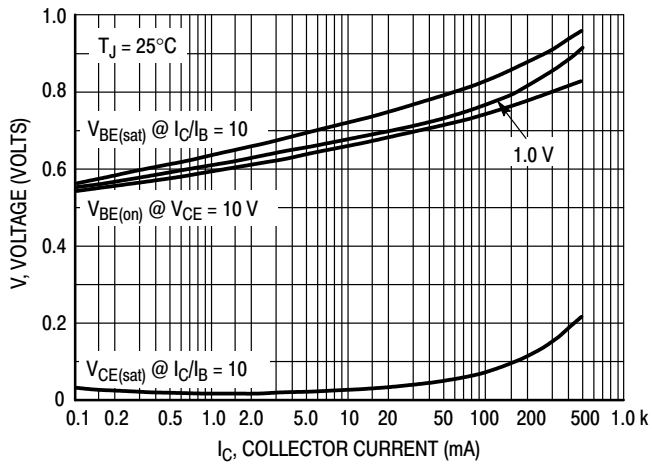

Figure 11. "On" Voltages

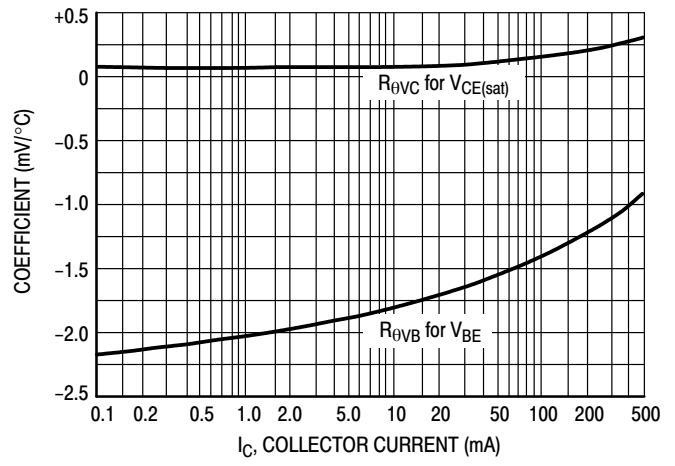
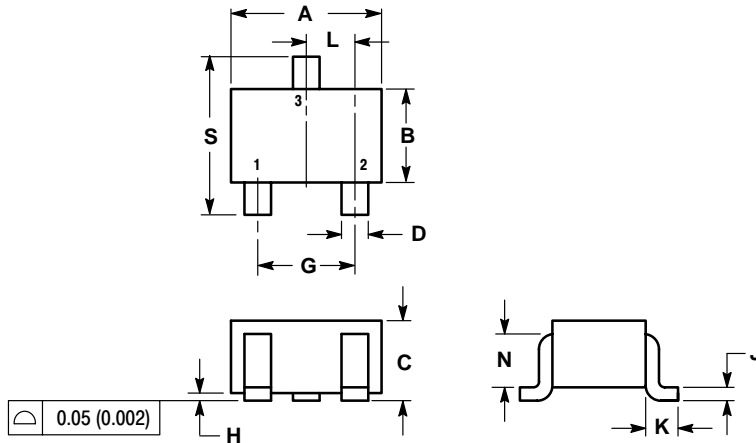

Figure 12. Temperature Coefficients

MMBT2222AWT1

PACKAGE DIMENSIONS

SC-70/SOT-323
CASE 419-04
ISSUE L



NOTES:

1. DIMENSIONING AND TOLERANCING PER ANSI Y14.5M, 1982.
2. CONTROLLING DIMENSION: INCH.

DIM	INCHES		MILLIMETERS	
	MIN	MAX	MIN	MAX
A	0.071	0.087	1.80	2.20
B	0.045	0.053	1.15	1.35
C	0.032	0.040	0.80	1.00
D	0.012	0.016	0.30	0.40
G	0.047	0.055	1.20	1.40
H	0.000	0.004	0.00	0.10
J	0.004	0.010	0.10	0.25
K	0.017 REF		0.425 REF	
L	0.026 BSC		0.650 BSC	
N	0.028 REF		0.700 REF	
S	0.079	0.095	2.00	2.40

STYLE 3:

- PIN 1. BASE
- EMITTER
- COLLECTOR

SOLDERING FOOTPRINT

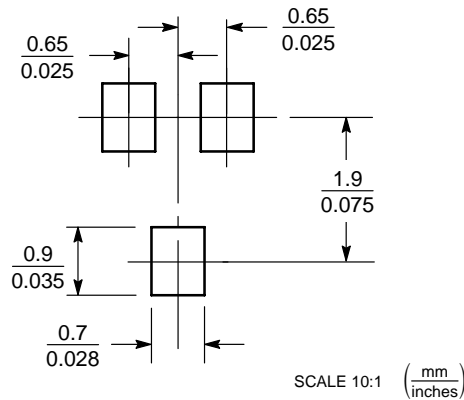

ON Semiconductor and are registered trademarks of Semiconductor Components Industries, LLC (SCILLC). SCILLC reserves the right to make changes without further notice to any products herein. SCILLC makes no warranty, representation or guarantee regarding the suitability of its products for any particular purpose, nor does SCILLC assume any liability arising out of the application or use of any product or circuit, and specifically disclaims any and all liability, including without limitation special, consequential or incidental damages. "Typical" parameters which may be provided in SCILLC data sheets and/or specifications can and do vary in different applications and actual performance may vary over time. All operating parameters, including "Typicals" must be validated for each customer application by customer's technical experts. SCILLC does not convey any license under its patent rights nor the rights of others. SCILLC products are not designed, intended, or authorized for use as components in systems intended for surgical implant into the body, or other applications intended to support or sustain life, or for any other application in which the failure of the SCILLC product could create a situation where personal injury or death may occur. Should Buyer purchase or use SCILLC products for any such unintended or unauthorized application, Buyer shall indemnify and hold SCILLC and its officers, employees, subsidiaries, affiliates, and distributors harmless against all claims, costs, damages, and expenses, and reasonable attorney fees arising out of, directly or indirectly, any claim of personal injury or death associated with such unintended or unauthorized use, even if such claim alleges that SCILLC was negligent regarding the design or manufacture of the part. SCILLC is an Equal Opportunity/Affirmative Action Employer. This literature is subject to all applicable copyright laws and is not for resale in any manner.

PUBLICATION ORDERING INFORMATION

LITERATURE FULFILLMENT:

Literature Distribution Center for ON Semiconductor
P.O. Box 61312, Phoenix, Arizona 85082-1312 USA
Phone: 480-829-7710 or 800-344-3860 Toll Free USA/Canada
Fax: 480-829-7709 or 800-344-3867 Toll Free USA/Canada
Email: orderlit@onsemi.com

N. American Technical Support: 800-282-9855 Toll Free USA/Canada

Japan: ON Semiconductor, Japan Customer Focus Center
2-9-1 Kamimeguro, Meguro-ku, Tokyo, Japan 153-0051
Phone: 81-3-5773-3850

ON Semiconductor Website: <http://onsemi.com>

Order Literature: <http://www.onsemi.com/litorder>

For additional information, please contact your local Sales Representative.