

MMBT5401LT1

Preferred Device

High Voltage Transistor

PNP Silicon

Features

- Pb-Free Packages are Available

MAXIMUM RATINGS

Rating	Symbol	Value	Unit
Collector–Emitter Voltage	V_{CEO}	–150	Vdc
Collector–Base Voltage	V_{CBO}	–160	Vdc
Emitter–Base Voltage	V_{EBO}	–5.0	Vdc
Collector Current – Continuous	I_C	–500	mAdc

Maximum ratings are those values beyond which device damage can occur. Maximum ratings applied to the device are individual stress limit values (not normal operating conditions) and are not valid simultaneously. If these limits are exceeded, device functional operation is not implied, damage may occur and reliability may be affected.

THERMAL CHARACTERISTICS

Characteristic	Symbol	Max	Unit
Total Device Dissipation FR–5 Board (Note 1) $T_A = 25^\circ\text{C}$ Derate Above 25°C	P_D	225	mW
Thermal Resistance, Junction–to–Ambient	$R_{\theta JA}$	556	$^\circ\text{C}/\text{W}$
Total Device Dissipation Alumina Substrate (Note 2) $T_A = 25^\circ\text{C}$ Derate Above 25°C	P_D	300	mW
Thermal Resistance, Junction–to–Ambient	$R_{\theta JA}$	417	$^\circ\text{C}/\text{W}$
Junction and Storage Temperature	T_J, T_{stg}	–55 to +150	$^\circ\text{C}$

- FR–5 = $1.0 \times 0.75 \times 0.062$ in.
- Alumina = $0.4 \times 0.3 \times 0.024$ in 99.5% alumina.



ON Semiconductor®

<http://onsemi.com>

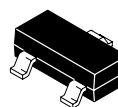
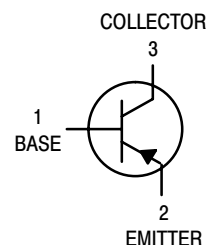

SOT–23 (TO–236)
CASE 318
STYLE 6

MARKING DIAGRAM

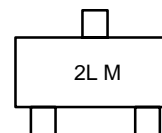

2L = Device Code
M = Month Code

ORDERING INFORMATION

Device	Package	Shipping†
MMBT5401LT1	SOT–23	3000 Tape & Reel
MMBT5401LT1G	SOT–23 (Pb–Free)	3000 Tape & Reel
MMBT5401LT3	SOT–23	10,000 Tape & Reel
MMBT5401LT3G	SOT–23 (Pb–Free)	10,000 Tape & Reel

†For information on tape and reel specifications, including part orientation and tape sizes, please refer to our Tape and Reel Packaging Specifications Brochure, BRD8011/D.

Preferred devices are recommended choices for future use and best overall value.

MMBT5401LT1

ELECTRICAL CHARACTERISTICS (T_A = 25°C unless otherwise noted)

Characteristic	Symbol	Min	Max	Unit
----------------	--------	-----	-----	------

OFF CHARACTERISTICS

Collector–Emitter Breakdown Voltage (I _C = –1.0 mA _{dc} , I _B = 0)	V _{(BR)CEO}	–150	–	Vdc
Collector–Base Breakdown Voltage (I _C = –100 μA _{dc} , I _E = 0)	V _{(BR)CBO}	–160	–	Vdc
Emitter–Base Breakdown Voltage (I _E = –10 μA _{dc} , I _C = 0)	V _{(BR)EBO}	–5.0	–	Vdc
Collector Cutoff Current (V _{CB} = –120 Vdc, I _E = 0) (V _{CB} = –120 Vdc, I _E = 0, T _A = 100°C)	I _{CES}	–	–50	nA _{dc} μA _{dc}

ON CHARACTERISTICS

DC Current Gain (I _C = –1.0 mA _{dc} , V _{CE} = –5.0 Vdc) (I _C = –10 mA _{dc} , V _{CE} = –5.0 Vdc) (I _C = –50 mA _{dc} , V _{CE} = –5.0 Vdc)	h _{FE}	50 60 50	– 240 –	–
Collector–Emitter Saturation Voltage (I _C = –10 mA _{dc} , I _B = –1.0 mA _{dc}) (I _C = –50 mA _{dc} , I _B = –5.0 mA _{dc})	V _{CE(sat)}	– –	–0.2 –0.5	Vdc
Base–Emitter Saturation Voltage (I _C = –10 mA _{dc} , I _B = –1.0 mA _{dc}) (I _C = –50 mA _{dc} , I _B = –5.0 mA _{dc})	V _{BE(sat)}	– –	–1.0 –1.0	Vdc

SMALL–SIGNAL CHARACTERISTICS

Current–Gain — Bandwidth Product (I _C = –10 mA _{dc} , V _{CE} = –10 Vdc, f = 100 MHz)	f _T	100	300	MHz
Output Capacitance (V _{CB} = –10 Vdc, I _E = 0, f = 1.0 MHz)	C _{obo}	–	6.0	pF
Small Signal Current Gain (I _C = –1.0 mA _{dc} , V _{CE} = –10 Vdc, f = 1.0 kHz)	h _{fe}	40	200	–
Noise Figure (I _C = –200 μA _{dc} , V _{CE} = –5.0 Vdc, R _S = 10 Ω, f = 1.0 kHz)	NF	–	8.0	dB

MMBT5401LT1

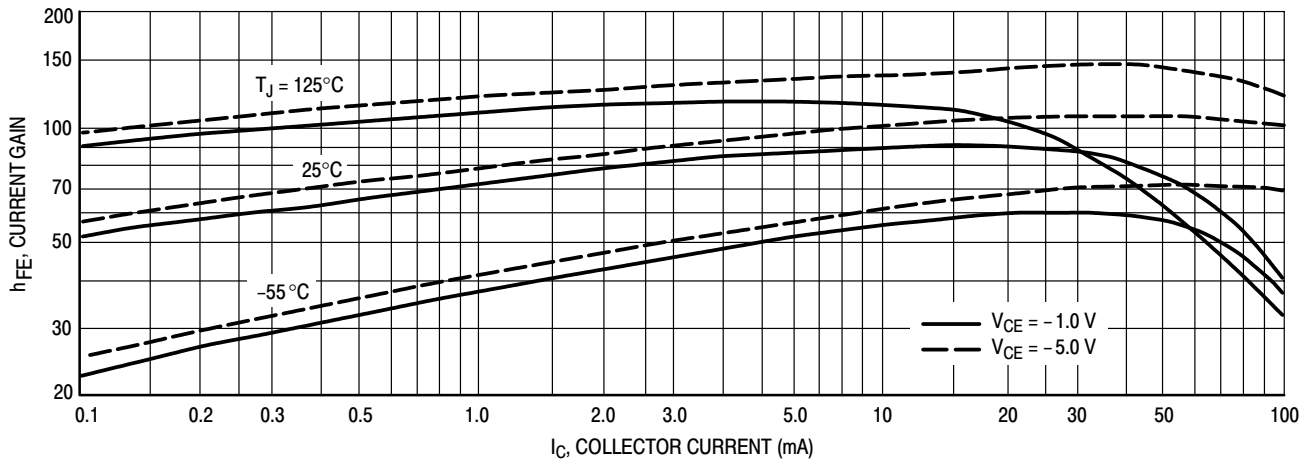

Figure 1. DC Current Gain

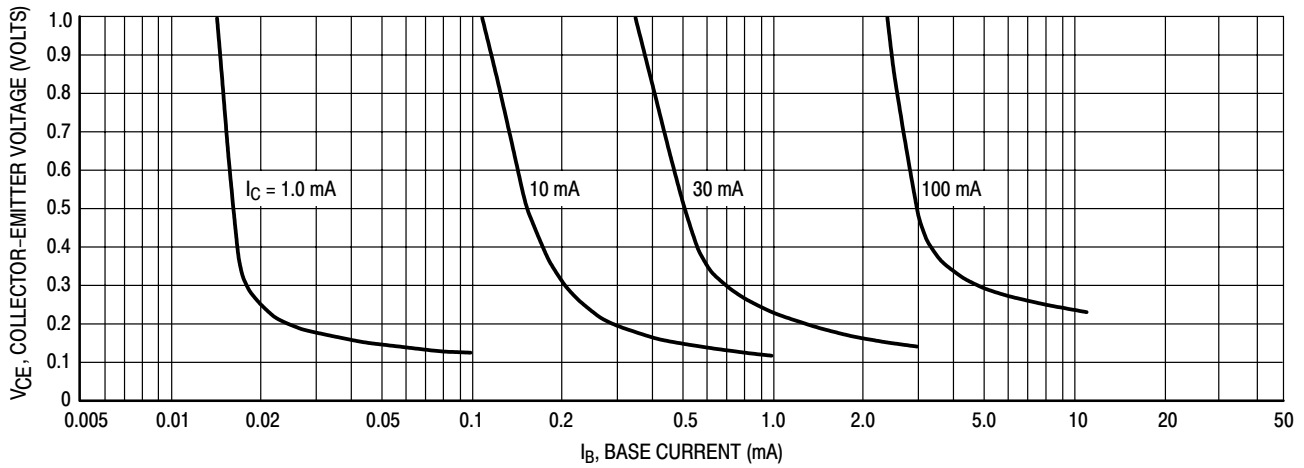

Figure 2. Collector Saturation Region

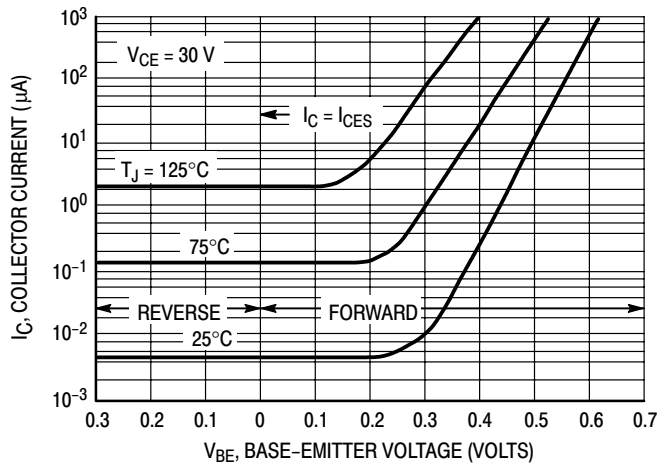

Figure 3. Collector Cut-Off Region

MMBT5401LT1

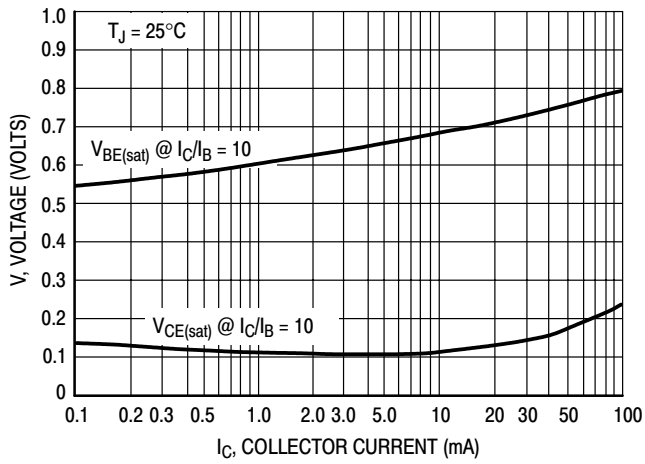

Figure 4. "On" Voltages

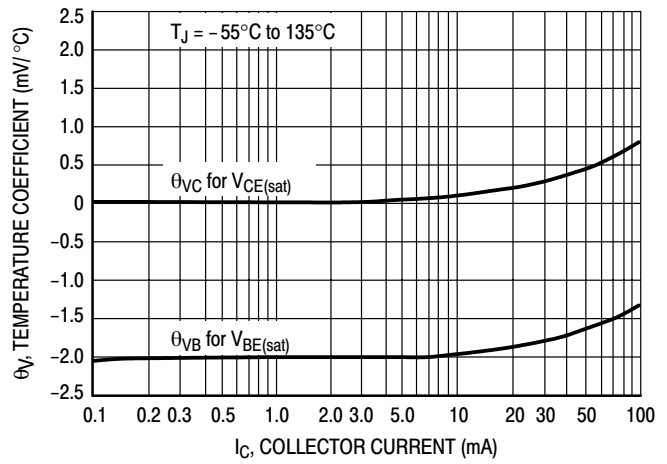

Figure 5. Temperature Coefficients

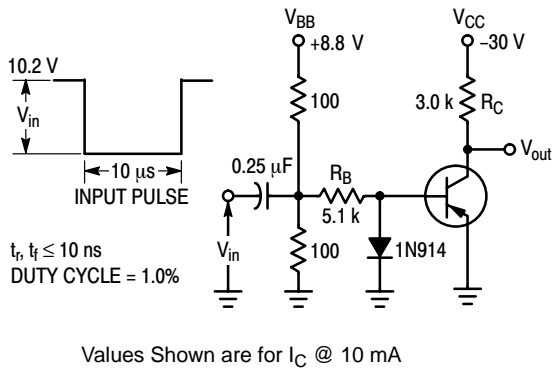

Figure 6. Switching Time Test Circuit

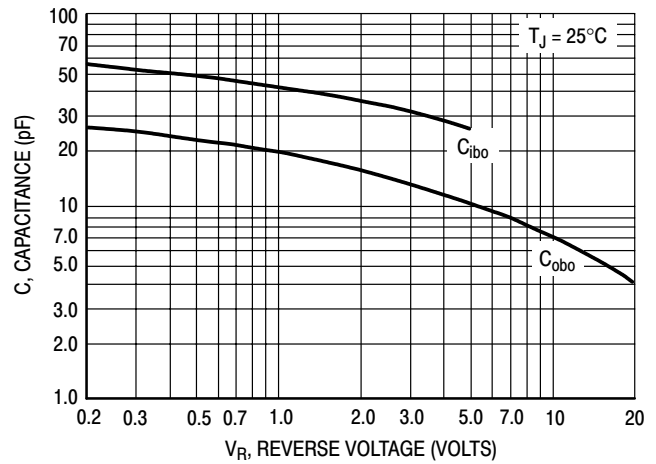

Figure 7. Capacitances

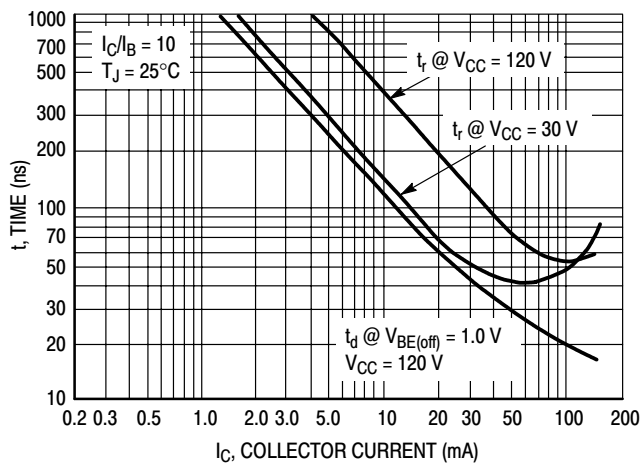

Figure 8. Turn-On Time

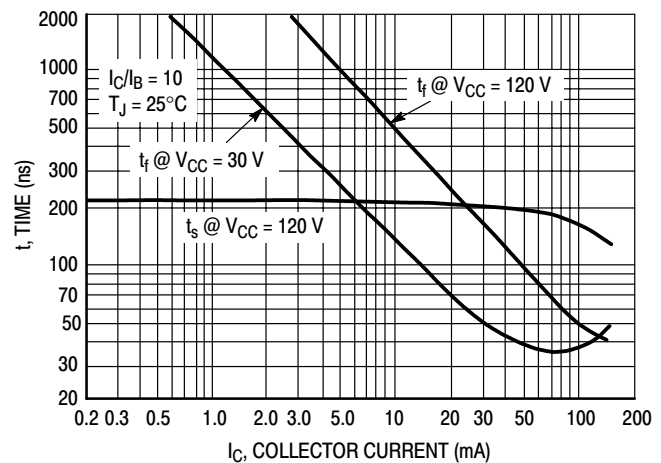
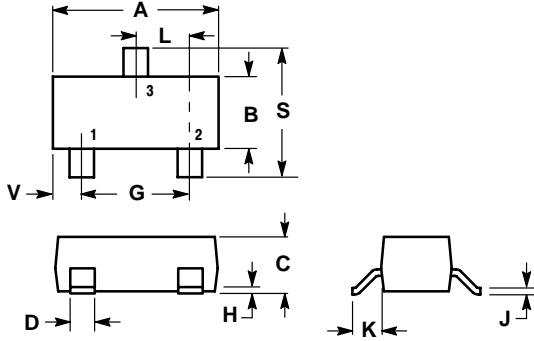

Figure 9. Turn-Off Time

MMBT5401LT1

PACKAGE DIMENSIONS

SOT-23-3 (TO-236)
CASE 318-08
ISSUE AK



- NOTES:
1. DIMENSIONING AND TOLERANCING PER ANSI Y14.5M, 1982.
 2. CONTROLLING DIMENSION: INCH.
 3. MAXIMUM LEAD THICKNESS INCLUDES LEAD FINISH THICKNESS. MINIMUM LEAD THICKNESS IS THE MINIMUM THICKNESS OF BASE MATERIAL.
 4. 318-01 THRU -07 AND -09 OBSOLETE, NEW STANDARD 318-08.

DIM	INCHES		MILLIMETERS	
	MIN	MAX	MIN	MAX
A	0.1102	0.1197	2.80	3.04
B	0.0472	0.0551	1.20	1.40
C	0.0350	0.0440	0.89	1.11
D	0.0150	0.0200	0.37	0.50
G	0.0701	0.0807	1.78	2.04
H	0.0005	0.0040	0.013	0.100
J	0.0034	0.0070	0.085	0.177
K	0.0140	0.0285	0.35	0.69
L	0.0350	0.0401	0.89	1.02
S	0.0830	0.1039	2.10	2.64
V	0.0177	0.0236	0.45	0.60

- STYLE 6:
PIN 1. BASE
2. EMITTER
3. COLLECTOR

SOLDERING FOOTPRINT*

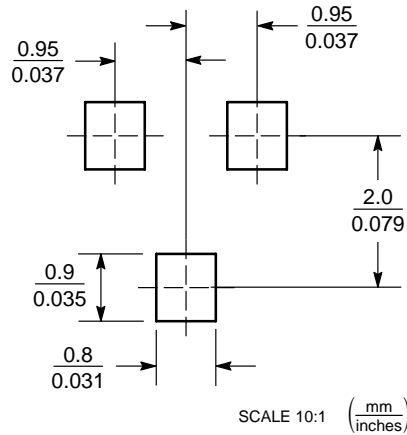

*For additional information on our Pb-Free strategy and soldering details, please download the ON Semiconductor Soldering and Mounting Techniques Reference Manual, SOLDERRM/D.

MMBT5401LT1

ON Semiconductor and  are registered trademarks of Semiconductor Components Industries, LLC (SCILLC). SCILLC reserves the right to make changes without further notice to any products herein. SCILLC makes no warranty, representation or guarantee regarding the suitability of its products for any particular purpose, nor does SCILLC assume any liability arising out of the application or use of any product or circuit, and specifically disclaims any and all liability, including without limitation special, consequential or incidental damages. "Typical" parameters which may be provided in SCILLC data sheets and/or specifications can and do vary in different applications and actual performance may vary over time. All operating parameters, including "Typicals" must be validated for each customer application by customer's technical experts. SCILLC does not convey any license under its patent rights nor the rights of others. SCILLC products are not designed, intended, or authorized for use as components in systems intended for surgical implant into the body, or other applications intended to support or sustain life, or for any other application in which the failure of the SCILLC product could create a situation where personal injury or death may occur. Should Buyer purchase or use SCILLC products for any such unintended or unauthorized application, Buyer shall indemnify and hold SCILLC and its officers, employees, subsidiaries, affiliates, and distributors harmless against all claims, costs, damages, and expenses, and reasonable attorney fees arising out of, directly or indirectly, any claim of personal injury or death associated with such unintended or unauthorized use, even if such claim alleges that SCILLC was negligent regarding the design or manufacture of the part. SCILLC is an Equal Opportunity/Affirmative Action Employer. This literature is subject to all applicable copyright laws and is not for resale in any manner.

PUBLICATION ORDERING INFORMATION

LITERATURE FULFILLMENT:

Literature Distribution Center for ON Semiconductor
P.O. Box 61312, Phoenix, Arizona 85082-1312 USA
Phone: 480-829-7710 or 800-344-3860 Toll Free USA/Canada
Fax: 480-829-7709 or 800-344-3867 Toll Free USA/Canada
Email: orderlit@onsemi.com

N. American Technical Support: 800-282-9855 Toll Free
USA/Canada

Japan: ON Semiconductor, Japan Customer Focus Center
2-9-1 Kamimeguro, Meguro-ku, Tokyo, Japan 153-0051
Phone: 81-3-5773-3850

ON Semiconductor Website: <http://onsemi.com>

Order Literature: <http://www.onsemi.com/litorder>

For additional information, please contact your
local Sales Representative.

MMBT5401LT1/D