

MPS2907A

Preferred Device

General Purpose Transistors

PNP Silicon



ON Semiconductor™

<http://onsemi.com>

MAXIMUM RATINGS

Rating	Symbol	Value	Unit
Collector–Emitter Voltage	V_{CEO}	–60	Vdc
Collector–Base Voltage	V_{CBO}	–60	Vdc
Emitter–Base Voltage	V_{EBO}	–5.0	Vdc
Collector Current – Continuous	I_C	–600	mAdc
Total Device Dissipation @ $T_A = 25^\circ\text{C}$ Derate above 25°C	P_D	625 5.0	mW mW/°C
Total Device Dissipation @ $T_C = 25^\circ\text{C}$ Derate above 25°C	P_D	1.5 12	Watts mW/°C
Operating and Storage Junction Temperature Range	T_J, T_{stg}	–55 to +150	°C

THERMAL CHARACTERISTICS

Characteristic	Symbol	Max	Unit
Thermal Resistance, Junction to Ambient	$R_{\theta JA}$	200	°C/W
Thermal Resistance, Junction to Case	$R_{\theta JC}$	83.3	°C/W

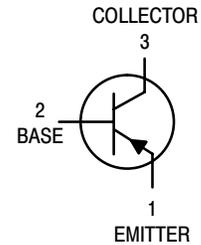

STYLE 1

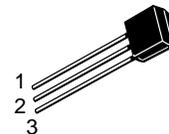

TO-92
CASE 29
STYLES 1, 14

MARKING DIAGRAMS

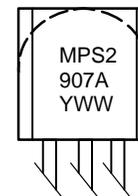

Y = Year
WW = Work Week

ORDERING INFORMATION

Device	Package	Shipping
MPS2907A	TO-92	5000 Units/Box
MPS2907ARLRA	TO-92	2000/Tape & Reel
MPS2907ARLRE	TO-92	2000/Ammo Pack
MPS2907ARLRM	TO-92	2000/Ammo Pack
MPS2907ARLRP	TO-92	2000/Ammo Pack

Preferred devices are recommended choices for future use and best overall value.

MPS2907A

ELECTRICAL CHARACTERISTICS (T_A = 25°C unless otherwise noted)

Characteristic	Symbol	Min	Max	Unit
OFF CHARACTERISTICS				
Collector–Emitter Breakdown Voltage (Note 1.) (I _C = –10 mA _{dc} , I _B = 0)	V _{(BR)CEO}	–60	–	V _{dc}
Collector–Base Breakdown Voltage (I _C = –10 μA _{dc} , I _E = 0)	V _{(BR)CBO}	–60	–	V _{dc}
Emitter–Base Breakdown Voltage (I _E = –10 μA _{dc} , I _C = 0)	V _{(BR)EBO}	–5.0	–	V _{dc}
Collector Cutoff Current (V _{CE} = –30 V _{dc} , V _{EB(off)} = –0.5 V _{dc})	I _{CEX}	–	–50	nA _{dc}
Collector Cutoff Current (V _{CB} = –50 V _{dc} , I _E = 0) (V _{CB} = –50 V _{dc} , I _E = 0, T _A = 150°C)	I _{CBO}	–	–0.01 –10	μA _{dc}
Base Current (V _{CE} = –30 V _{dc} , V _{EB(off)} = –0.5 V _{dc})	I _B	–	–50	nA _{dc}

ON CHARACTERISTICS

DC Current Gain (I _C = –0.1 mA _{dc} , V _{CE} = –10 V _{dc}) (I _C = –1.0 mA _{dc} , V _{CE} = –10 V _{dc}) (I _C = –10 mA _{dc} , V _{CE} = –10 V _{dc}) (I _C = –150 mA _{dc} , V _{CE} = –10 V _{dc}) (Note 1.) (I _C = –500 mA _{dc} , V _{CE} = –10 V _{dc}) (Note 1.)	h _{FE}	75 100 100 100 50	– – – 300 –	–
Collector–Emitter Saturation Voltage (Note 1.) (I _C = –150 mA _{dc} , I _B = –15 mA _{dc}) (I _C = –500 mA _{dc} , I _B = –50 mA _{dc})	V _{CE(sat)}	– –	–0.4 –1.6	V _{dc}
Base–Emitter Saturation Voltage (Note 1.) (I _C = –150 mA _{dc} , I _B = –15 mA _{dc}) (I _C = –500 mA _{dc} , I _B = –50 mA _{dc})	V _{BE(sat)}	– –	–1.3 –2.6	V _{dc}

SMALL–SIGNAL CHARACTERISTICS

Current–Gain – Bandwidth Product (Notes 1. and 2.), (I _C = –50 mA _{dc} , V _{CE} = –20 V _{dc} , f = 100 MHz)	f _T	200	–	MHz
Output Capacitance (V _{CB} = –10 V _{dc} , I _E = 0, f = 1.0 MHz)	C _{obo}	–	8.0	pF
Input Capacitance (V _{EB} = –2.0 V _{dc} , I _C = 0, f = 1.0 MHz)	C _{ibo}	–	30	pF

SWITCHING CHARACTERISTICS

Turn–On Time	(V _{CC} = –30 V _{dc} , I _C = –150 mA _{dc} , I _{B1} = –15 mA _{dc}) (Figures 1 and 5)	t _{on}	–	45	ns
Delay Time		t _d	–	10	ns
Rise Time		t _r	–	40	ns
Turn–Off Time	(V _{CC} = –6.0 V _{dc} , I _C = –150 mA _{dc} , I _{B1} = I _{B2} = 15 mA _{dc}) (Figure 2)	t _{off}	–	100	ns
Storage Time		t _s	–	80	ns
Fall Time		t _f	–	30	ns

1. Pulse Test: Pulse Width ≤ 300 μs, Duty Cycle ≤ 2%.
2. f_T is defined as the frequency at which |h_{fe}| extrapolates to unity.

MPS2907A

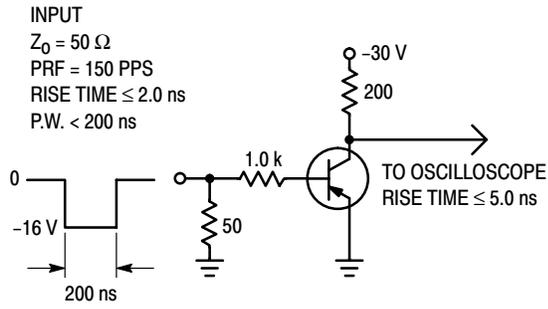

Figure 1. Delay and Rise Time Test Circuit

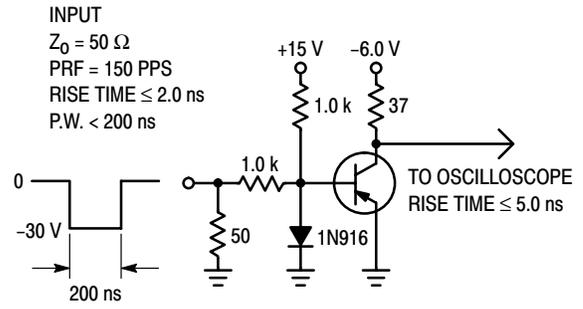

Figure 2. Storage and Fall Time Test Circuit

TYPICAL CHARACTERISTICS

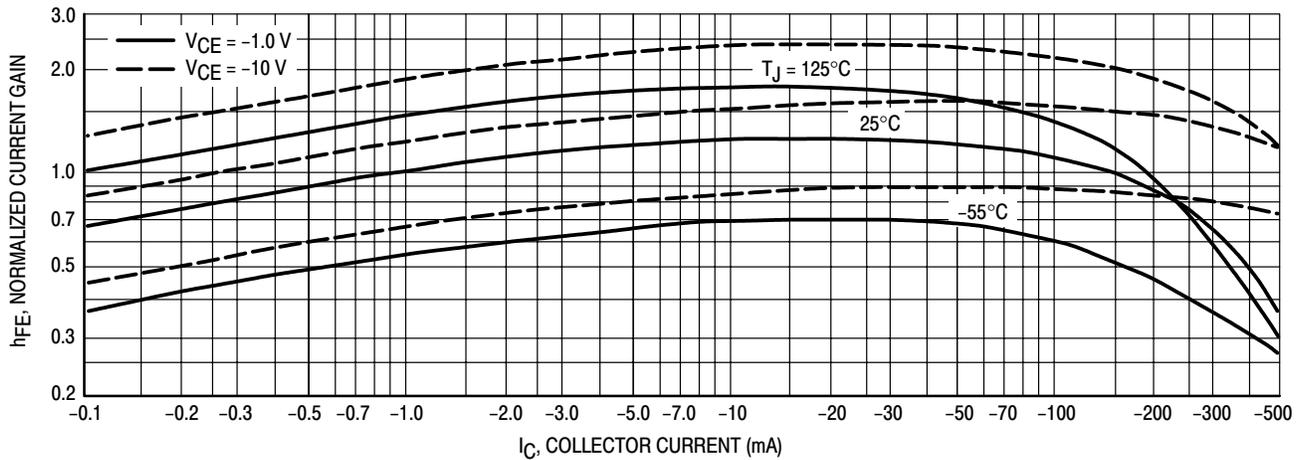

Figure 3. DC Current Gain

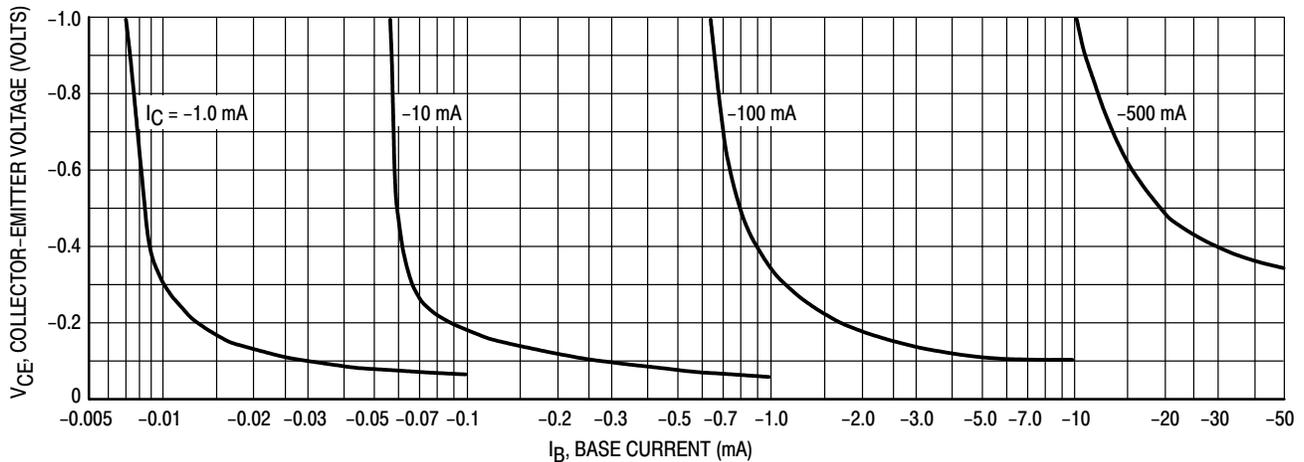

Figure 4. Collector Saturation Region

MPS2907A

TYPICAL CHARACTERISTICS

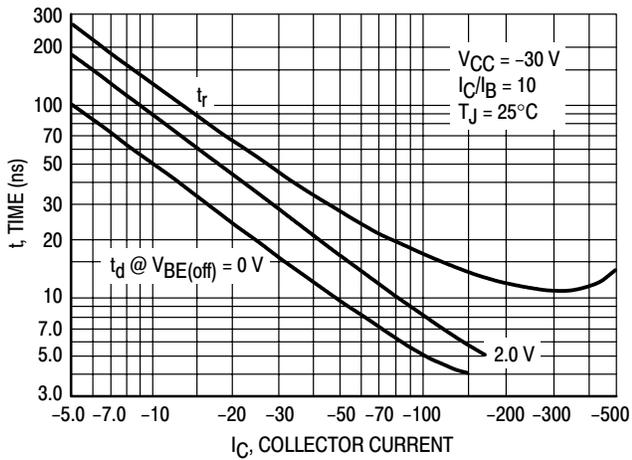

Figure 5. Turn-On Time

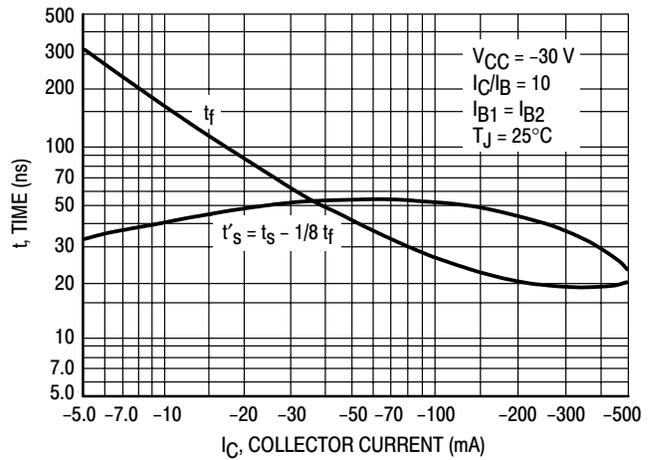

Figure 6. Turn-Off Time

TYPICAL SMALL-SIGNAL CHARACTERISTICS

NOISE FIGURE

$V_{CE} = 10 \text{ Vdc}$, $T_A = 25^\circ\text{C}$

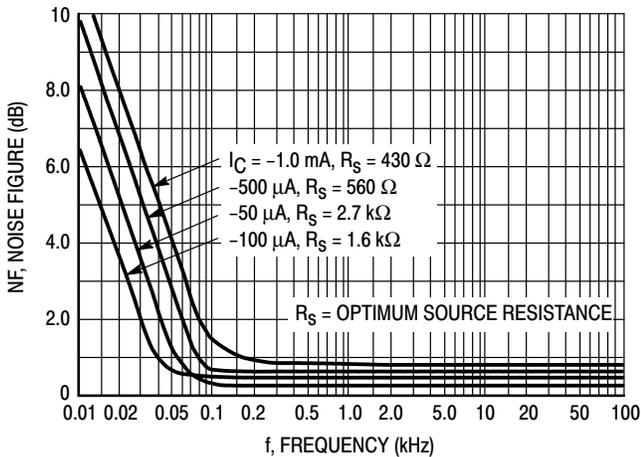

Figure 7. Frequency Effects

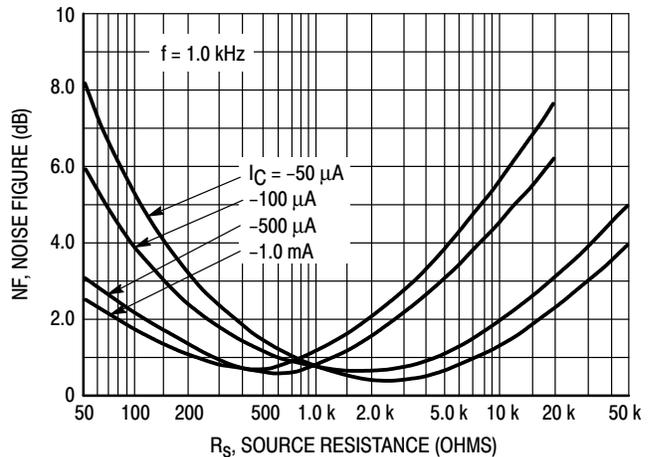

Figure 8. Source Resistance Effects

MPS2907A

TYPICAL SMALL-SIGNAL CHARACTERISTICS

NOISE FIGURE

$V_{CE} = 10 \text{ Vdc}$, $T_A = 25^\circ\text{C}$

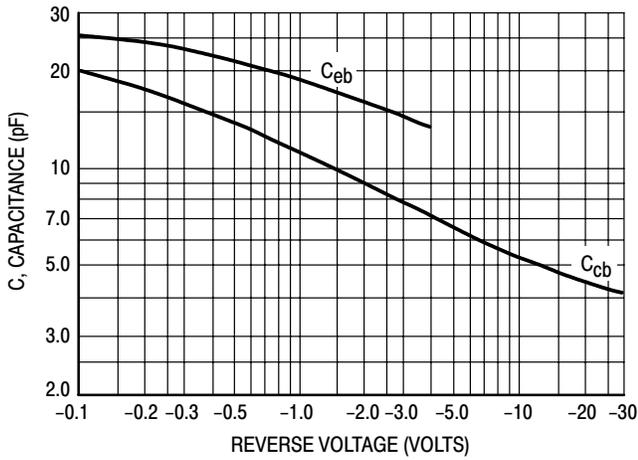

Figure 9. Capacitances

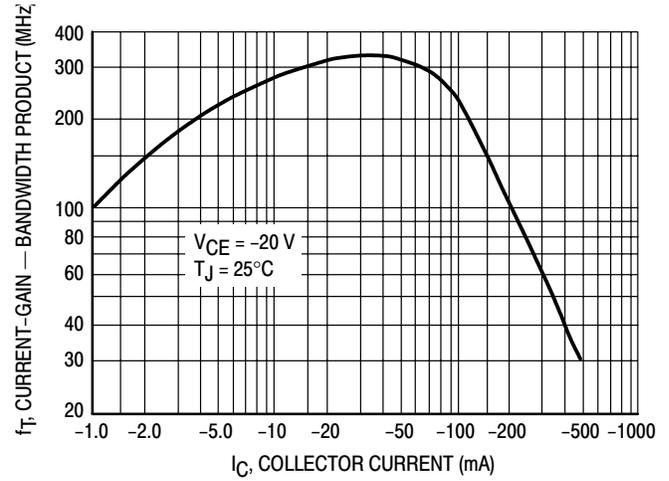

Figure 10. Current-Gain — Bandwidth Product

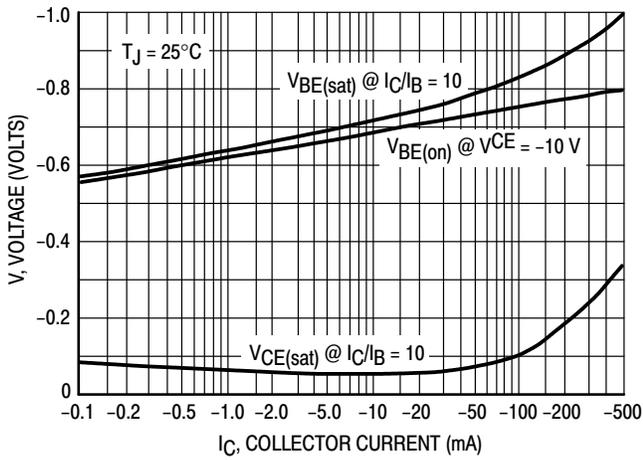

Figure 11. "On" Voltage

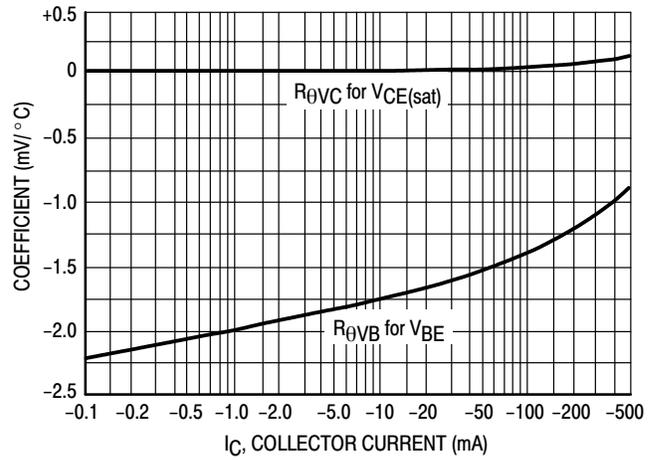
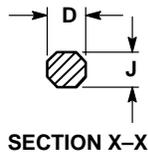
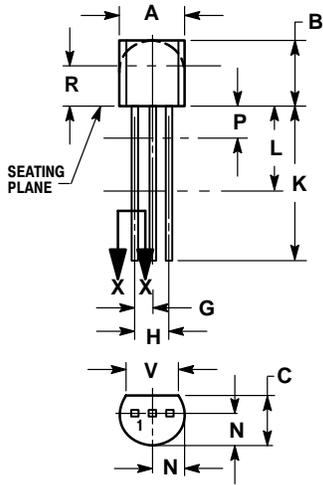

Figure 12. Temperature Coefficients

MPS2907A

PACKAGE DIMENSIONS

TO-92
TO-226AA
CASE 29-11
ISSUE AL



NOTES:

1. DIMENSIONING AND TOLERANCING PER ANSI Y14.5M, 1982.
2. CONTROLLING DIMENSION: INCH.
3. CONTOUR OF PACKAGE BEYOND DIMENSION R IS UNCONTROLLED.
4. LEAD DIMENSION IS UNCONTROLLED IN P AND BEYOND DIMENSION K MINIMUM.

DIM	INCHES		MILLIMETERS	
	MIN	MAX	MIN	MAX
A	0.175	0.205	4.45	5.20
B	0.170	0.210	4.32	5.33
C	0.125	0.165	3.18	4.19
D	0.016	0.021	0.407	0.533
G	0.045	0.055	1.15	1.39
H	0.095	0.105	2.42	2.66
J	0.015	0.020	0.39	0.50
K	0.500	---	12.70	---
L	0.250	---	6.35	---
N	0.080	0.105	2.04	2.66
P	---	0.100	---	2.54
R	0.115	---	2.93	---
V	0.135	---	3.43	---

STYLE 1:

- PIN 1. EMITTER
2. BASE
3. COLLECTOR

STYLE 14:

- PIN 1. EMITTER
2. COLLECTOR
3. BASE

Notes

MPS2907A

ON Semiconductor and  are trademarks of Semiconductor Components Industries, LLC (SCILLC). SCILLC reserves the right to make changes without further notice to any products herein. SCILLC makes no warranty, representation or guarantee regarding the suitability of its products for any particular purpose, nor does SCILLC assume any liability arising out of the application or use of any product or circuit, and specifically disclaims any and all liability, including without limitation special, consequential or incidental damages. "Typical" parameters which may be provided in SCILLC data sheets and/or specifications can and do vary in different applications and actual performance may vary over time. All operating parameters, including "Typicals" must be validated for each customer application by customer's technical experts. SCILLC does not convey any license under its patent rights nor the rights of others. SCILLC products are not designed, intended, or authorized for use as components in systems intended for surgical implant into the body, or other applications intended to support or sustain life, or for any other application in which the failure of the SCILLC product could create a situation where personal injury or death may occur. Should Buyer purchase or use SCILLC products for any such unintended or unauthorized application, Buyer shall indemnify and hold SCILLC and its officers, employees, subsidiaries, affiliates, and distributors harmless against all claims, costs, damages, and expenses, and reasonable attorney fees arising out of, directly or indirectly, any claim of personal injury or death associated with such unintended or unauthorized use, even if such claim alleges that SCILLC was negligent regarding the design or manufacture of the part. SCILLC is an Equal Opportunity/Affirmative Action Employer.

PUBLICATION ORDERING INFORMATION

Literature Fulfillment:

Literature Distribution Center for ON Semiconductor
P.O. Box 5163, Denver, Colorado 80217 USA
Phone: 303-675-2175 or 800-344-3860 Toll Free USA/Canada
Fax: 303-675-2176 or 800-344-3867 Toll Free USA/Canada
Email: ONlit@hibbertco.com

N. American Technical Support: 800-282-9855 Toll Free USA/Canada

JAPAN: ON Semiconductor, Japan Customer Focus Center
4-32-1 Nishi-Gotanda, Shinagawa-ku, Tokyo, Japan 141-0031
Phone: 81-3-5740-2700
Email: r14525@onsemi.com

ON Semiconductor Website: <http://onsemi.com>

For additional information, please contact your local Sales Representative.