

Switching Transistor

NPN Silicon

MPS3646

ON Semiconductor Preferred Device

MAXIMUM RATINGS

Rating	Symbol	Value	Unit
Collector–Emitter Voltage	V_{CEO}	15	Vdc
Collector–Emitter Voltage	V_{CES}	40	Vdc
Collector–Base Voltage	V_{CBO}	40	Vdc
Emitter–Base Voltage	V_{EBO}	5.0	Vdc
Collector Current — Continuous	I_C	300	mAdc
— 10 μ s Pulse		500	
Total Device Dissipation @ $T_A = 25^\circ\text{C}$	P_D	625	mW
Derate above 25°C		5.0	mW/ $^\circ\text{C}$
Total Device Dissipation @ $T_C = 25^\circ\text{C}$	P_D	1.5	Watts
Derate above 25°C		12	mW/ $^\circ\text{C}$
Operating and Storage Junction Temperature Range	T_J, T_{stg}	-55 to +150	$^\circ\text{C}$

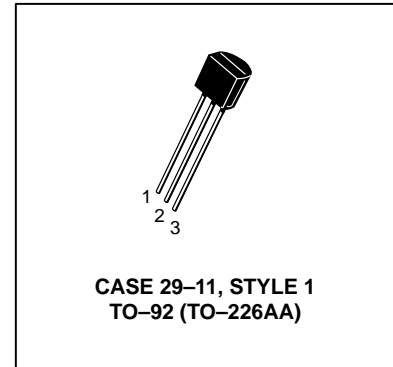

CASE 29-11, STYLE 1
TO-92 (TO-226AA)

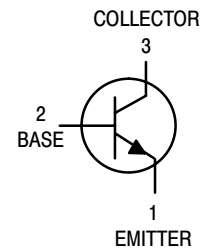

THERMAL CHARACTERISTICS

Characteristic	Symbol	Max	Unit
Thermal Resistance, Junction to Ambient	$R_{\theta JA}$	200	$^\circ\text{C}/\text{W}$
Thermal Resistance, Junction to Case	$R_{\theta JC}$	83.3	$^\circ\text{C}/\text{W}$

ELECTRICAL CHARACTERISTICS ($T_A = 25^\circ\text{C}$ unless otherwise noted)

Characteristic	Symbol	Min	Max	Unit
----------------	--------	-----	-----	------

OFF CHARACTERISTICS

Collector–Emitter Breakdown Voltage	($I_C = 100 \mu\text{Adc}, V_{BE} = 0$)	$V_{(BR)CES}$	40	—	Vdc
Collector–Emitter Sustaining Voltage ⁽¹⁾	($I_C = 10 \text{mAdc}, I_B = 0$)	$V_{CEO(sus)}$	15	—	Vdc
Collector–Base Breakdown Voltage	($I_C = 100 \mu\text{Adc}, I_E = 0$)	$V_{(BR)CBO}$	40	—	Vdc
Emitter–Base Breakdown Voltage	($I_E = 100 \mu\text{Adc}, I_C = 0$)	$V_{(BR)EBO}$	5.0	—	Vdc
Collector Cutoff Current	($V_{CE} = 20 \text{Vdc}, V_{BE} = 0$) ($V_{CE} = 20 \text{Vdc}, V_{BE} = 0, T_A = 65^\circ\text{C}$)	I_{CES}	—	0.5 3.0	μAdc

ON CHARACTERISTICS⁽¹⁾

DC Current Gain	($I_C = 30 \text{mAdc}, V_{CE} = 0.4 \text{Vdc}$) ($I_C = 100 \text{mAdc}, V_{CE} = 0.5 \text{Vdc}$) ($I_C = 300 \text{mA}, V_{CE} = 1.0 \text{Vdc}$)	h_{FE}	30 25 15	120 — —	—
Collector–Emitter Saturation Voltage	($I_C = 30 \text{mAdc}, I_B = 3.0 \text{mAdc}$) ($I_C = 100 \text{mAdc}, I_B = 10 \text{mAdc}$) ($I_C = 300 \text{mAdc}, I_B = 30 \text{mAdc}$) ($I_C = 30 \text{mA}, I_B = 3.0 \text{mA}, T_A = 65^\circ\text{C}$)	$V_{CE(sat)}$	— — — —	0.2 0.28 0.5 0.3	Vdc
Base–Emitter Saturation Voltage	($I_C = 30 \text{mAdc}, I_B = 3.0 \text{mAdc}$) ($I_C = 100 \text{mAdc}, I_B = 10 \text{mAdc}$) ($I_C = 300 \text{mAdc}, I_B = 30 \text{mA}$)	$V_{BE(sat)}$	0.73 — —	0.95 1.2 1.7	Vdc

1. Pulse Test: Pulse Width $\leq 300 \mu\text{s}$; Duty Cycle $\leq 2.0\%$.

Preferred devices are ON Semiconductor recommended choices for future use and best overall value.

MPS3646

ELECTRICAL CHARACTERISTICS ($T_A = 25^\circ\text{C}$ unless otherwise noted) (Continued)

Characteristic	Symbol	Min	Max	Unit
SMALL-SIGNAL CHARACTERISTICS				
Current-Gain — Bandwidth Product ($I_C = 30\text{ mA dc}$, $V_{CE} = 10\text{ V dc}$, $f = 100\text{ MHz}$)	f_T	350	—	MHz
Output Capacitance ($V_{CB} = 5.0\text{ V dc}$, $I_E = 0$, $f = 1.0\text{ MHz}$)	C_{obo}	—	5.0	pF
Input Capacitance ($V_{EB} = 0.5\text{ V dc}$, $I_C = 0$, $f = 1.0\text{ MHz}$)	C_{ibo}	—	9.0	pF

SWITCHING CHARACTERISTICS

Turn-On Time	$(V_{CC} = 10\text{ V dc}$, $I_C = 300\text{ mA dc}$, $I_{B1} = 30\text{ mA dc}$) (Figure 1)	t_{on}	—	18	ns
Delay Time		t_d	—	10	ns
Rise Time		t_r	—	15	ns
Turn-Off Time	$(V_{CC} = 10\text{ V dc}$, $I_C = 300\text{ mA dc}$, $I_{B1} = I_{B2} = 30\text{ mA dc}$) (Figure 1)	t_{off}	—	28	ns
Fall Time		t_f	—	15	ns
Storage Time ($V_{CC} = 10\text{ V dc}$, $I_C = 10\text{ mA dc}$, $I_{B1} = I_{B2} = 10\text{ mA dc}$) (Figure 2)		t_s	—	18	ns

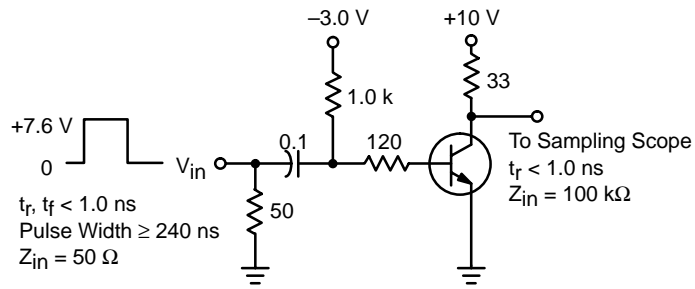

Figure 1. Switching Time Test Circuit

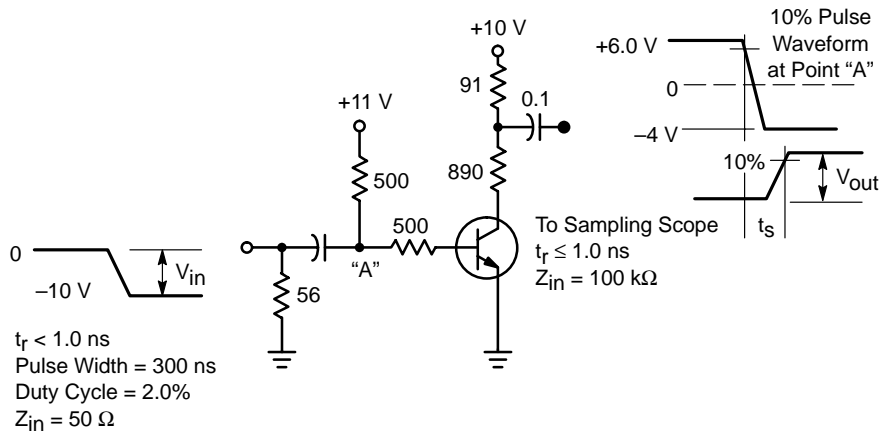

Figure 2. Charge Storage Time Test Circuit

MPS3646

CURRENT GAIN CHARACTERISTICS

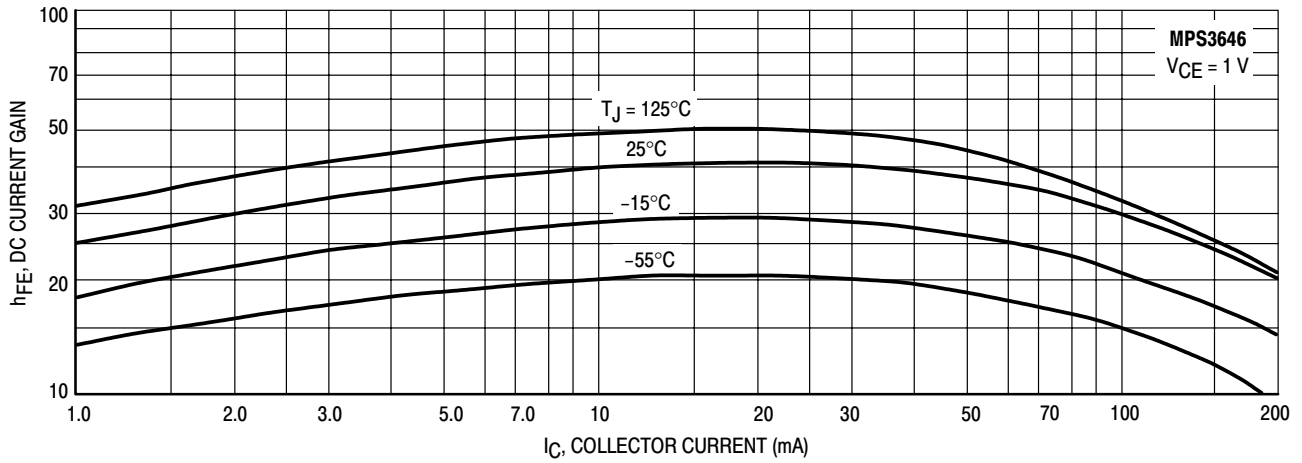

Figure 3. Minimum Current Gain

“ON” CONDITION CHARACTERISTICS

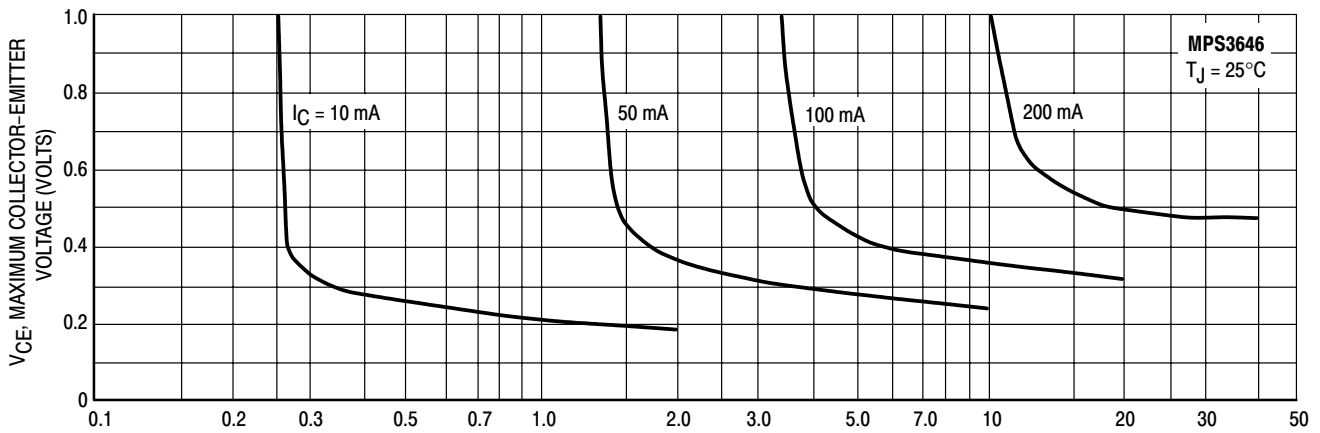

Figure 4. Collector Saturation Region

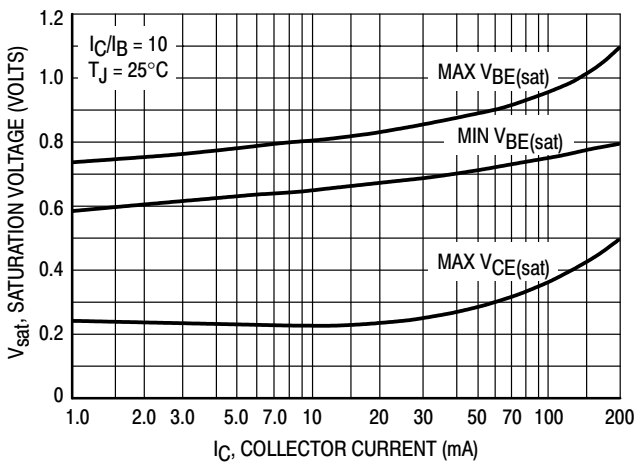

Figure 5. Saturation Voltage Limits

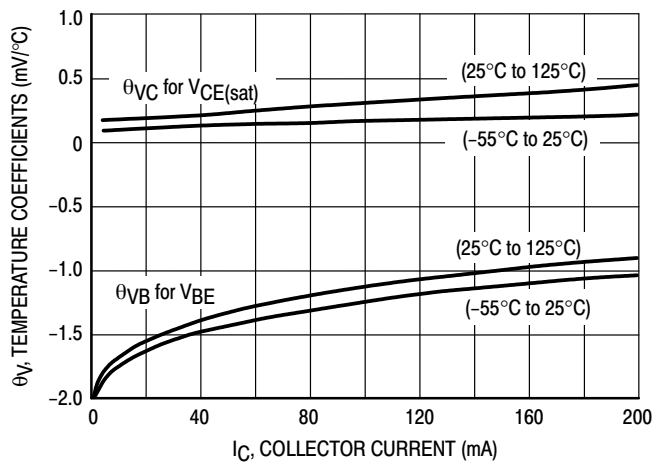

Figure 6. Temperature Coefficients

DYNAMIC CHARACTERISTICS

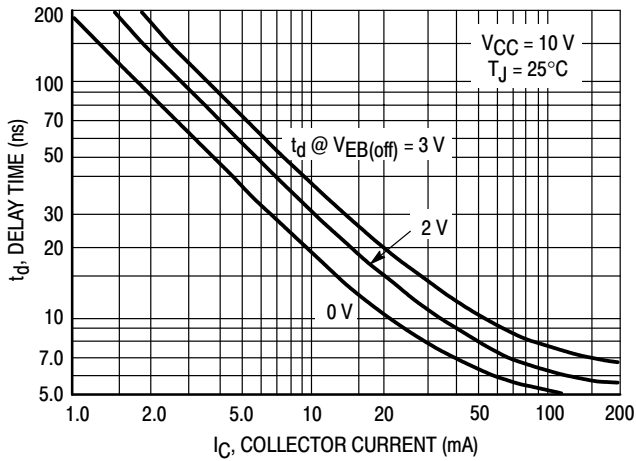

Figure 7. Delay Time

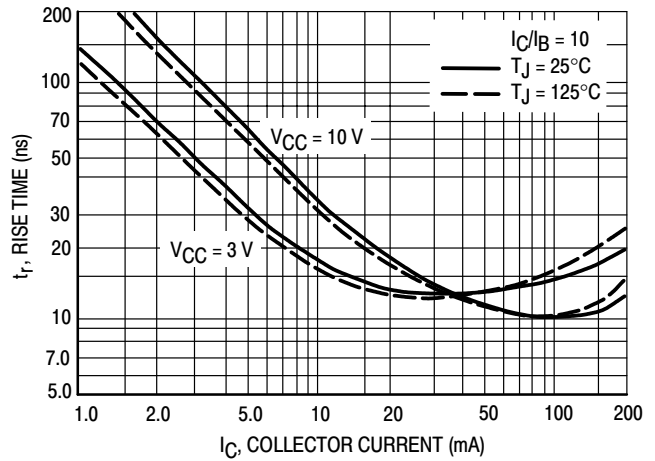

Figure 8. Rise Time

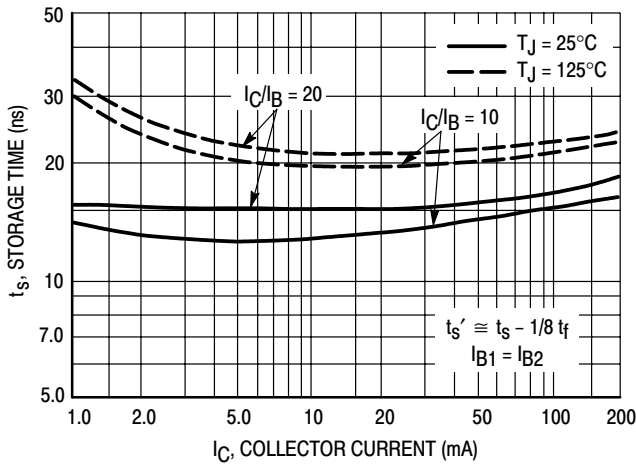

Figure 9. Storage Time

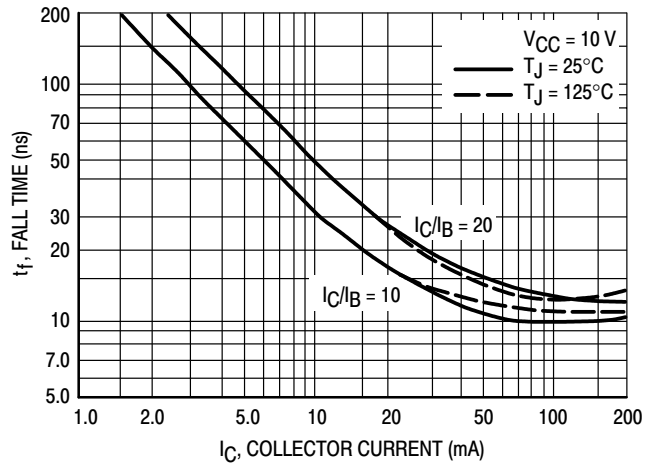

Figure 10. Fall Time

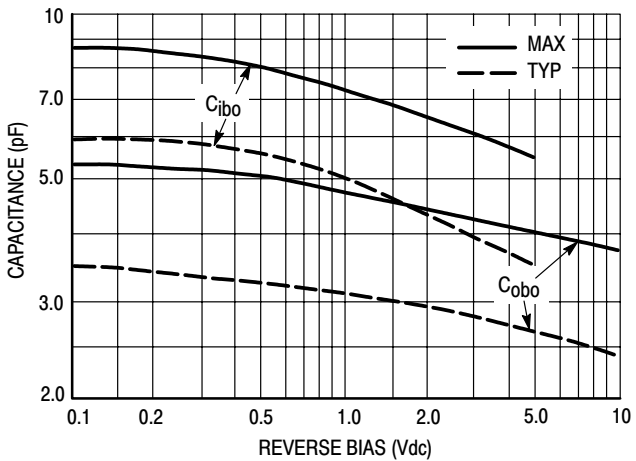

Figure 11. Junction Capacitance

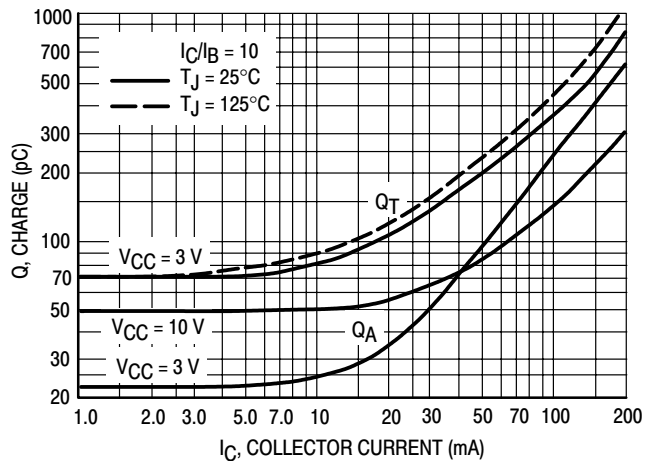
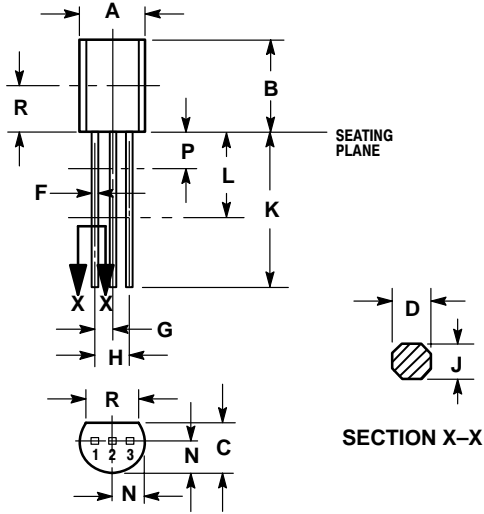

Figure 12. Maximum Charge Data

MPS3646

PACKAGE DIMENSIONS

CASE 029-11 (TO-226AA) ISSUE AD



SEATING
PLANE

SECTION X-X

STYLE 1:
PIN 1. EMITTER
2. BASE
3. COLLECTOR

- NOTES:
1. DIMENSIONING AND TOLERANCING PER ANSI Y14.5M, 1982.
 2. CONTROLLING DIMENSION: INCH.
 3. CONTOUR OF PACKAGE BEYOND DIMENSION R IS UNCONTROLLED.
 4. DIMENSION F APPLIES BETWEEN P AND L. DIMENSIONS D AND J APPLY BETWEEN L AND K MINIMUM. LEAD DIMENSION IS UNCONTROLLED IN P AND BEYOND DIMENSION K MINIMUM.

DIM	INCHES		MILLIMETERS	
	MIN	MAX	MIN	MAX
A	0.175	0.205	4.44	5.21
B	0.290	0.310	7.37	7.87
C	0.125	0.165	3.18	4.19
D	0.018	0.021	0.457	0.533
F	0.016	0.019	0.407	0.482
G	0.045	0.055	1.15	1.39
H	0.095	0.105	2.42	2.66
J	0.018	0.024	0.46	0.61
K	0.500	---	12.70	---
L	0.250	---	6.35	---
N	0.080	0.105	2.04	2.66
P	---	0.100	---	2.54
R	0.135	---	3.43	---

Notes

Notes

ON Semiconductor and  are trademarks of Semiconductor Components Industries, LLC (SCILLC). SCILLC reserves the right to make changes without further notice to any products herein. SCILLC makes no warranty, representation or guarantee regarding the suitability of its products for any particular purpose, nor does SCILLC assume any liability arising out of the application or use of any product or circuit, and specifically disclaims any and all liability, including without limitation special, consequential or incidental damages. "Typical" parameters which may be provided in SCILLC data sheets and/or specifications can and do vary in different applications and actual performance may vary over time. All operating parameters, including "Typicals" must be validated for each customer application by customer's technical experts. SCILLC does not convey any license under its patent rights nor the rights of others. SCILLC products are not designed, intended, or authorized for use as components in systems intended for surgical implant into the body, or other applications intended to support or sustain life, or for any other application in which the failure of the SCILLC product could create a situation where personal injury or death may occur. Should Buyer purchase or use SCILLC products for any such unintended or unauthorized application, Buyer shall indemnify and hold SCILLC and its officers, employees, subsidiaries, affiliates, and distributors harmless against all claims, costs, damages, and expenses, and reasonable attorney fees arising out of, directly or indirectly, any claim of personal injury or death associated with such unintended or unauthorized use, even if such claim alleges that SCILLC was negligent regarding the design or manufacture of the part. SCILLC is an Equal Opportunity/Affirmative Action Employer.

PUBLICATION ORDERING INFORMATION

Literature Fulfillment:

Literature Distribution Center for ON Semiconductor
P.O. Box 5163, Denver, Colorado 80217 USA
Phone: 303-675-2175 or 800-344-3860 Toll Free USA/Canada
Fax: 303-675-2176 or 800-344-3867 Toll Free USA/Canada
Email: ONlit@hibbertco.com

N. American Technical Support: 800-282-9855 Toll Free USA/Canada

JAPAN: ON Semiconductor, Japan Customer Focus Center
4-32-1 Nishi-Gotanda, Shinagawa-ku, Tokyo, Japan 141-0031
Phone: 81-3-5740-2700
Email: r14525@onsemi.com

ON Semiconductor Website: <http://onsemi.com>

For additional information, please contact your local Sales Representative.