

MUN2111T1 Series

Preferred Devices

Bias Resistor Transistors

PNP Silicon Surface Mount Transistors with Monolithic Bias Resistor Network

This new series of digital transistors is designed to replace a single device and its external resistor bias network. The Bias Resistor Transistor (BRT) contains a single transistor with a monolithic bias network consisting of two resistors; a series base resistor and a base-emitter resistor. The BRT eliminates these individual components by integrating them into a single device. The use of a BRT can reduce both system cost and board space. The device is housed in the SC-59 package which is designed for low power surface mount applications.

- Simplifies Circuit Design
- Reduces Board Space
- Reduces Component Count
- Moisture Sensitivity Level: 1
- ESD Rating – Human Body Model: Class 1
– Machine Model: Class B
- The SC-59 package can be soldered using wave or reflow.
The modified gull-winged leads absorb thermal stress during soldering eliminating the possibility of damage to the die.
- Pb-Free Package is Available

MAXIMUM RATINGS ($T_A = 25^\circ\text{C}$ unless otherwise noted)

Rating	Symbol	Value	Unit
Collector-Base Voltage	V_{CBO}	50	Vdc
Collector-Emitter Voltage	V_{CEO}	50	Vdc
Collector Current	I_C	100	mAdc

THERMAL CHARACTERISTICS

Characteristic	Symbol	Max	Unit
Total Device Dissipation $T_A = 25^\circ\text{C}$ Derate above 25°C	P_D	230 (Note 1) 338 (Note 2) 1.8 (Note 1) 2.7 (Note 2)	mW $^\circ\text{C}/\text{W}$
Thermal Resistance – Junction-to-Ambient	$R_{\theta JA}$	540 (Note 1) 370 (Note 2)	$^\circ\text{C}/\text{W}$
Thermal Resistance – Junction-to-Lead	$R_{\theta JL}$	264 (Note 1) 287 (Note 2)	$^\circ\text{C}/\text{W}$
Junction and Storage Temperature Range	T_J, T_{stg}	-55 to +150	$^\circ\text{C}$

Maximum ratings are those values beyond which device damage can occur. Maximum ratings applied to the device are individual stress limit values (not normal operating conditions) and are not valid simultaneously. If these limits are exceeded, device functional operation is not implied, damage may occur and reliability may be affected.

1. FR-4 @ Minimum Pad.
2. FR-4 @ 1.0 x 1.0 inch Pad.



ON Semiconductor®

<http://onsemi.com>

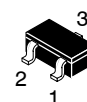
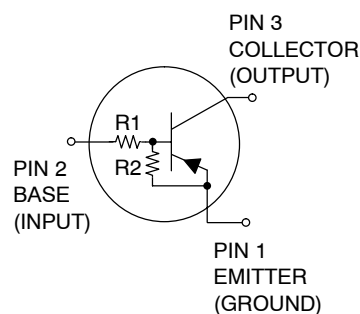

SC-59
CASE 318D
PLASTIC

MARKING DIAGRAM

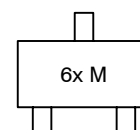

6x = Specific Device Code*
M = Date Code

ORDERING INFORMATION

See detailed ordering and shipping information on page 2 of this data sheet.

DEVICE MARKING INFORMATION

*See device marking table on page 2 of this data sheet.

Preferred devices are recommended choices for future use and best overall value.

MUN2111T1 Series

DEVICE MARKING AND RESISTOR VALUES

Device	Package	Marking	R1 (K)	R2 (K)	Shipping [†]
MUN2111T1	SC-59	6A	10	10	3000 / Tape & Reel
MUN2111T1G	SC-59 (Pb-Free)	6A	10	10	3000 / Tape & Reel
MUN2112T1	SC-59	6B	22	22	3000 / Tape & Reel
MUN2112T1G	SC-59 (Pb-Free)	6B	22	22	3000 / Tape & Reel
MUN2113T1	SC-59	6C	47	47	3000 / Tape & Reel
MUN2113T1G	SC-59 (Pb-Free)	6C	47	47	3000 / Tape & Reel
MUN2114T1	SC-59	6D	10	47	3000 / Tape & Reel
MUN2114T1G	SC-59 (Pb-Free)	6D	10	47	3000 / Tape & Reel
MUN2115T1 (Note 3)	SC-59	6E	10	∞	3000 / Tape & Reel
MUN2116T1 (Note 3)	SC-59	6F	4.7	∞	3000 / Tape & Reel
MUN2116T1G (Note 3)	SC-59 (Pb-Free)	6F	4.7	∞	3000 / Tape & Reel
MUN2130T1 (Note 3)	SC-59	6G	1.0	1.0	3000 / Tape & Reel
MUN2131T1 (Note 3)	SC-59	6H	2.2	2.2	3000 / Tape & Reel
MUN2132T1 (Note 3)	SC-59	6J	4.7	4.7	3000 / Tape & Reel
MUN2132T1G (Note 3)	SC-59 (Pb-Free)	6J	4.7	4.7	3000 / Tape & Reel
MUN2133T1 (Note 3)	SC-59	6K	4.7	47	3000 / Tape & Reel
MUN2134T1 (Note 3)	SC-59	6L	22	47	3000 / Tape & Reel
MUN2136T1	SC-59	6N	100	100	3000 / Tape & Reel
MUN2137T1	SC-59	6P	47	22	3000 / Tape & Reel
MUN2140T1 (Note 3)	SC-59	6T	47	∞	3000 / Tape & Reel

[†]For information on tape and reel specifications, including part orientation and tape sizes, please refer to our Tape and Reel Packaging Specifications Brochure, BRD8011/D.

3. New resistor combinations. Updated curves to follow in subsequent data sheets.

MUN211T1 Series

ELECTRICAL CHARACTERISTICS (T_A = 25°C unless otherwise noted)

Characteristic	Symbol	Min	Typ	Max	Unit
OFF CHARACTERISTICS					
Collector-Base Cutoff Current (V _{CB} = 50 V, I _E = 0)	I _{CBO}	-	-	100	nAdc
Collector-Emitter Cutoff Current (V _{CE} = 50 V, I _B = 0)	I _{CEO}	-	-	500	nAdc
Emitter-Base Cutoff Current (V _{EB} = 6.0 V, I _C = 0)	I _{EBO}	-	-	0.5	mAdc
	MUN211T1	-	-	0.2	
	MUN212T1	-	-	0.1	
	MUN2113T1	-	-	0.2	
	MUN2114T1	-	-	0.9	
	MUN2115T1	-	-	1.9	
	MUN2116T1	-	-	4.3	
	MUN2130T1	-	-	2.3	
	MUN2131T1	-	-	1.5	
	MUN2132T1	-	-	0.18	
	MUN2133T1	-	-	0.13	
	MUN2134T1	-	-	0.05	
	MUN2136T1	-	-	0.13	
	MUN2137T1	-	-	0.20	
	MUN2140T1	-	-		
Collector-Base Breakdown Voltage (I _C = 10 μA, I _E = 0)	V _{(BR)CBO}	50	-	-	Vdc
Collector-Emitter Breakdown Voltage (Note 4) (I _C = 2.0 mA, I _B = 0)	V _{(BR)CEO}	50	-	-	Vdc

ON CHARACTERISTICS (Note 4)

DC Current Gain (V _{CE} = 10 V, I _C = 5.0 mA)	h _{FE}	35	60	-	
	MUN211T1	60	100	-	
	MUN212T1	80	140	-	
	MUN2113T1	80	140	-	
	MUN2114T1	160	250	-	
	MUN2115T1	160	250	-	
	MUN2116T1	3.0	5.0	-	
	MUN2130T1	8.0	15	-	
	MUN2131T1	15	27	-	
	MUN2132T1	80	140	-	
	MUN2133T1	80	130	-	
	MUN2134T1	80	150	-	
	MUN2136T1	80	140	-	
	MUN2137T1	120	250	-	
	MUN2140T1				
Collector-Emitter Saturation Voltage (I _C = 10 mA, I _B = 0.3 mA)	V _{CE(sat)}	-	-	0.25	Vdc
	MUN211T1	-	-	0.25	
	MUN212T1	-	-	0.25	
	MUN2113T1	-	-	0.25	
	MUN2114T1	-	-	0.25	
	MUN2115T1	-	-	0.25	
	MUN2130T1	-	-	0.25	
	MUN2136T1	-	-	0.25	
	MUN2137T1	-	-	0.25	
(I _C = 10 mA, I _B = 5.0 mA)	MUN2131T1	-	-	0.25	
(I _C = 10 mA, I _B = 1.0 mA)	MUN2116T1	-	-	0.25	
	MUN2132T1	-	-	0.25	
	MUN2134T1	-	-	0.25	
	MUN2140T1	-	-	0.25	
Output Voltage (on) (V _{CC} = 5.0 V, V _B = 2.5 V, R _L = 1.0 kΩ)	V _{OL}	-	-	0.2	Vdc
	MUN211T1	-	-	0.2	
	MUN212T1	-	-	0.2	
	MUN2114T1	-	-	0.2	
	MUN2115T1	-	-	0.2	
	MUN2116T1	-	-	0.2	
	MUN2130T1	-	-	0.2	
	MUN2131T1	-	-	0.2	
	MUN2132T1	-	-	0.2	
	MUN2133T1	-	-	0.2	
	MUN2134T1	-	-	0.2	
(V _{CC} = 5.0 V, V _B = 3.5 V, R _L = 1.0 kΩ)	MUN2113T1	-	-	0.2	
	MUN2140T1	-	-	0.2	
(V _{CC} = 5.0 V, V _B = 5.5 V, R _L = 1.0 kΩ)	MUN2136T1	-	-	0.2	
(V _{CC} = 5.0 V, V _B = 4.0 V, R _L = 1.0 kΩ)	MUN2137T1	-	-	0.2	

4. Pulse Test: Pulse Width < 300 μs, Duty Cycle < 2.0%.

MUN211T1 Series

ELECTRICAL CHARACTERISTICS ($T_A = 25^\circ\text{C}$ unless otherwise noted)

Characteristic	Symbol	Min	Typ	Max	Unit
ON CHARACTERISTICS (Note 4)					
Output Voltage (off) ($V_{CC} = 5.0\text{ V}$, $V_B = 0.5\text{ V}$, $R_L = 1.0\text{ k}\Omega$) ($V_{CC} = 5.0\text{ V}$, $V_B = 0.050\text{ V}$, $R_L = 1.0\text{ k}\Omega$) ($V_{CC} = 5.0\text{ V}$, $V_B = 0.25\text{ V}$, $R_L = 1.0\text{ k}\Omega$)	V_{OH}	4.9	–	–	Vdc
Input Resistor	R1	7.0	10	13	k Ω
		15.4	22	28.6	
		32.9	47	61.1	
		7.0	10	13	
		7.0	10	13	
		3.3	4.7	6.1	
		0.7	1.0	1.3	
		1.5	2.2	2.9	
		3.3	4.7	6.1	
		3.3	4.7	6.1	
		15.4	22	28.6	
		70	100	130	
		32.9	47	61.1	
		32.9	47	61.1	
Resistor Ratio	R_1/R_2	0.8	1.0	1.2	
		0.17	0.21	0.25	
		–	–	–	
		0.8	1.0	1.2	
		0.055	0.1	0.185	
		0.38	0.47	0.56	
		1.7	2.1	2.6	

4. Pulse Test: Pulse Width < 300 μs , Duty Cycle < 2.0%.

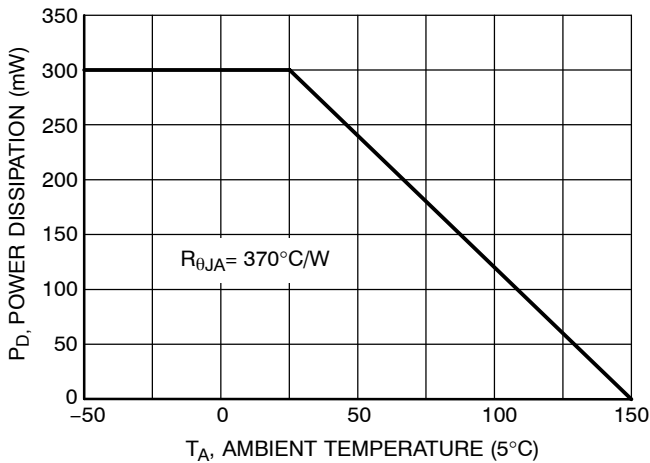

Figure 1. Derating Curve

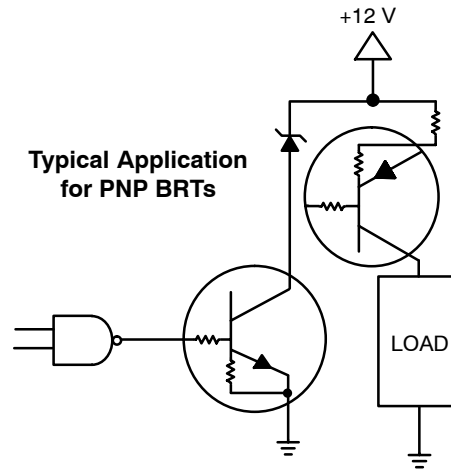

Figure 2. Inexpensive, Unregulated Current Source

MUN2111T1 Series

TYPICAL ELECTRICAL CHARACTERISTICS – MUN2111T1

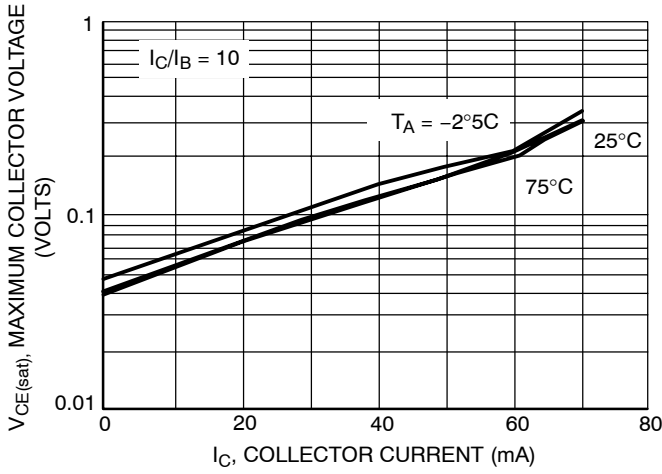

Figure 3. $V_{CE(sat)}$ vs. I_C

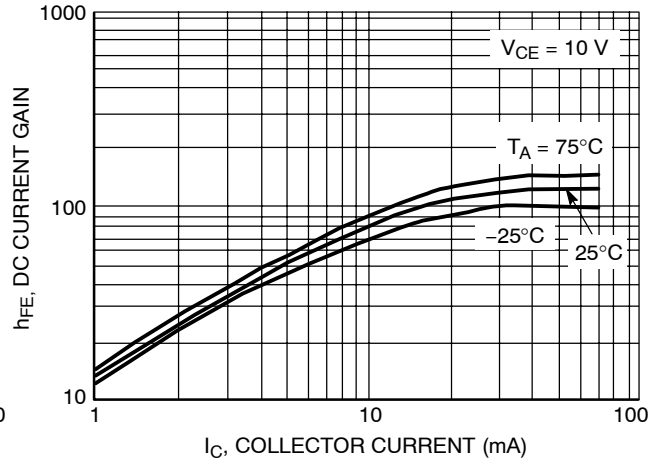

Figure 4. DC Current Gain

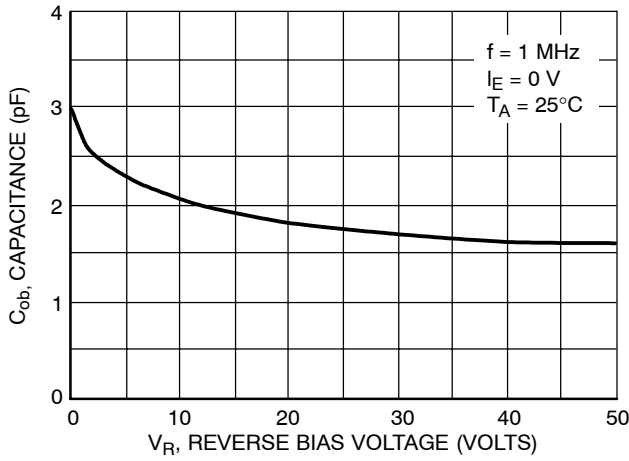

Figure 5. Output Capacitance

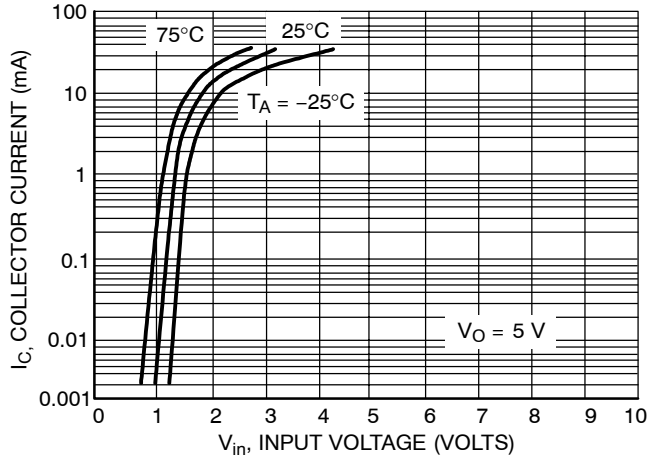

Figure 6. Output Current vs. Input Voltage

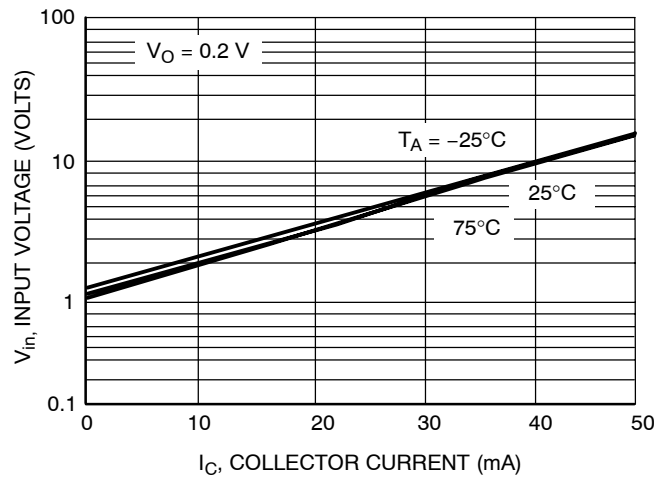

Figure 7. Input Voltage vs. Output Current

MUN2111T1 Series

TYPICAL ELECTRICAL CHARACTERISTICS – MUN2112T1

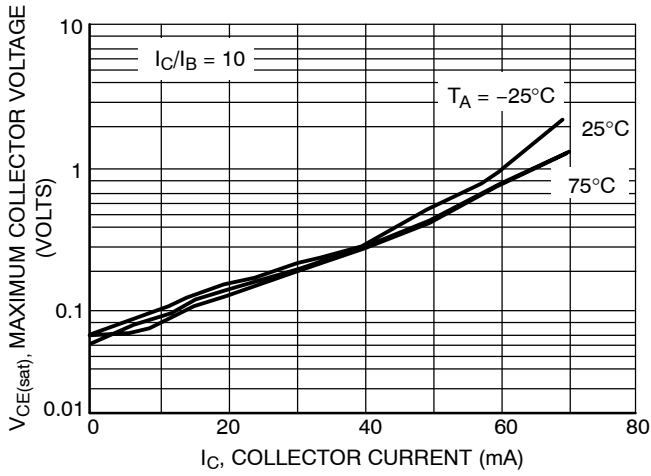

Figure 8. $V_{CE(sat)}$ vs. I_C

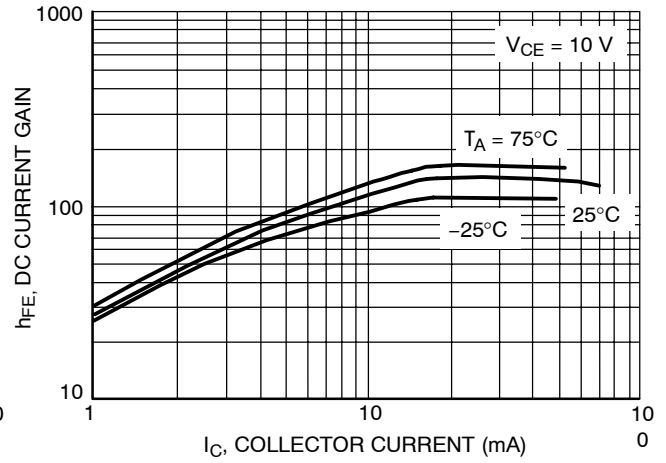

Figure 9. DC Current Gain

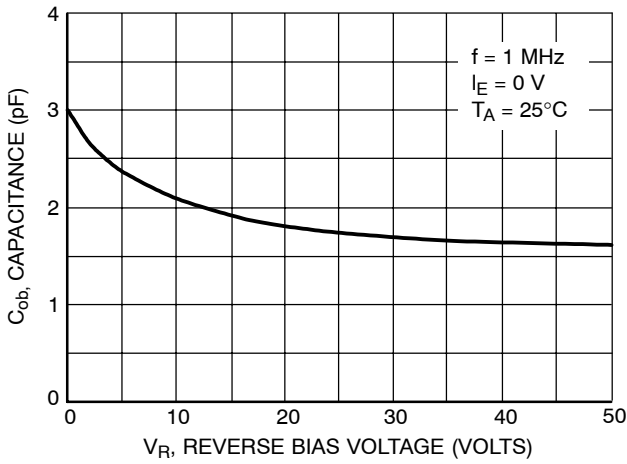

Figure 10. Output Capacitance

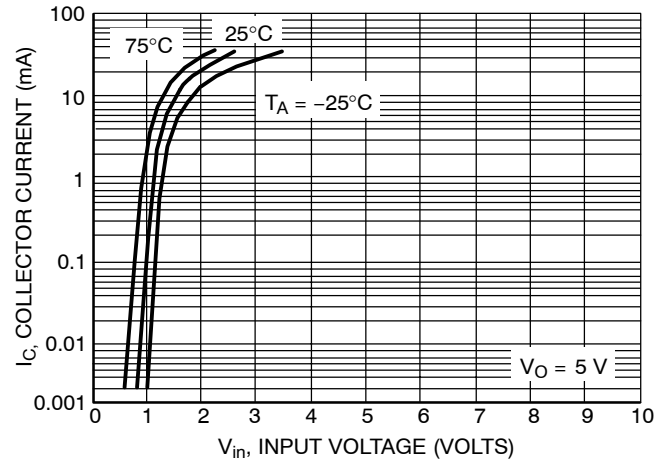

Figure 11. Output Current vs. Input Voltage

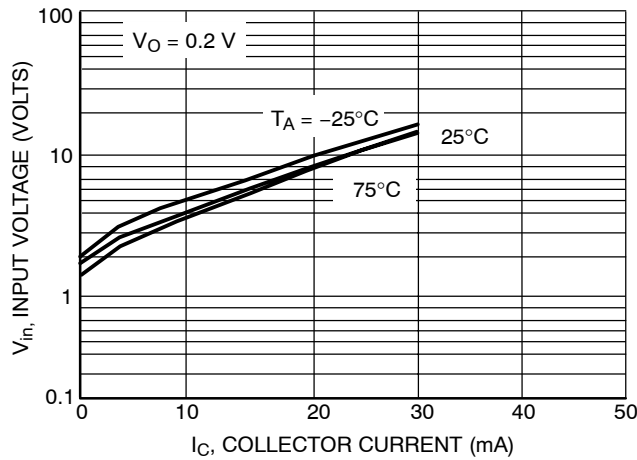

Figure 12. Input Voltage vs. Output Current

MUN2111T1 Series

TYPICAL ELECTRICAL CHARACTERISTICS – MUN2113T1

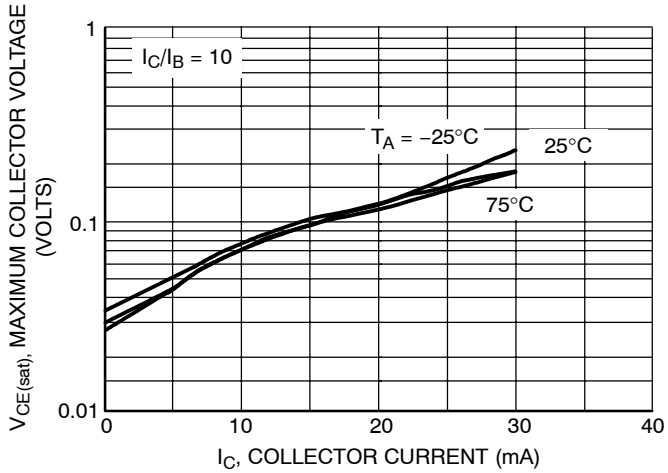

Figure 13. $V_{CE(sat)}$ vs. I_C

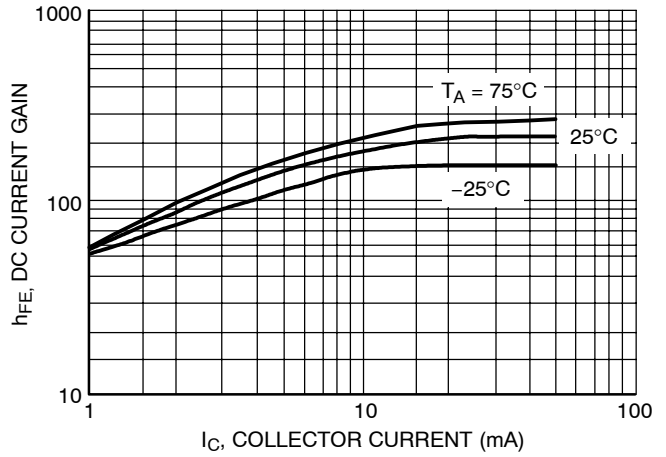

Figure 14. DC Current Gain

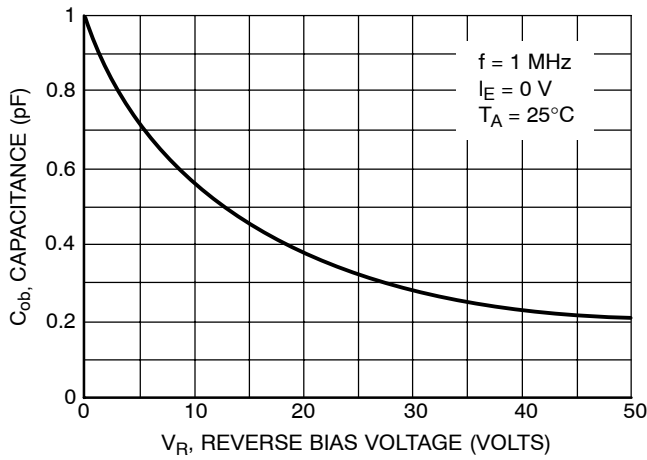

Figure 15. Output Capacitance

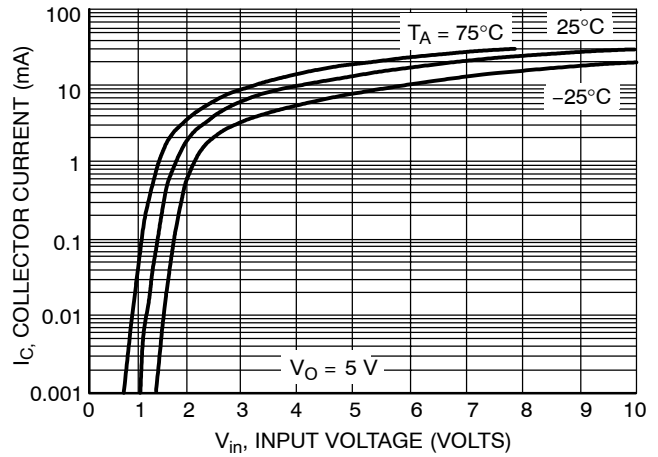

Figure 16. Output Current vs. Input Voltage

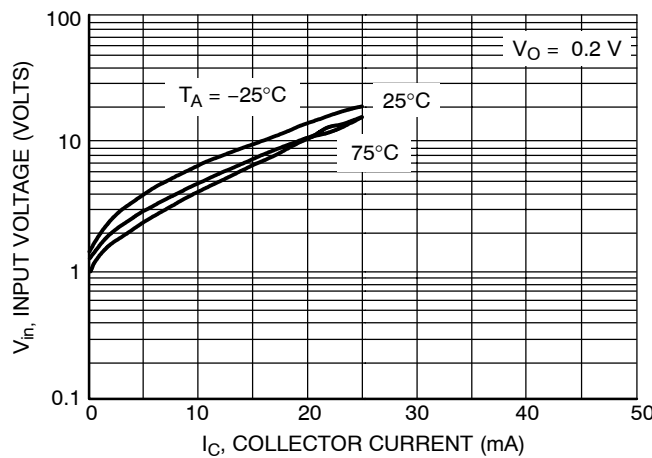

Figure 17. Input Voltage vs. Output Current

MUN2111T1 Series

TYPICAL ELECTRICAL CHARACTERISTICS – MUN2114T1

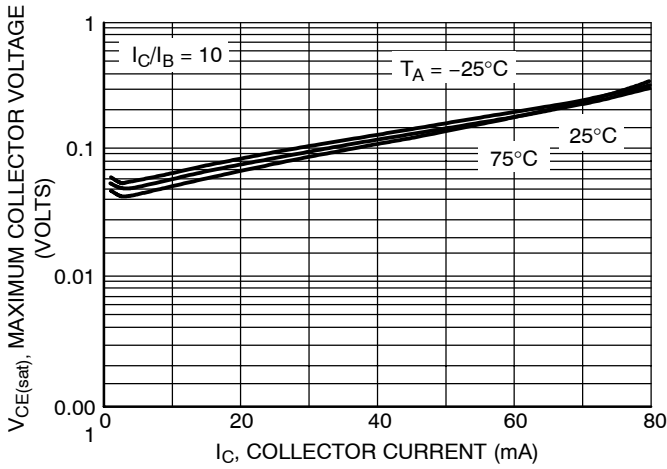

Figure 18. $V_{CE(sat)}$ vs. I_C

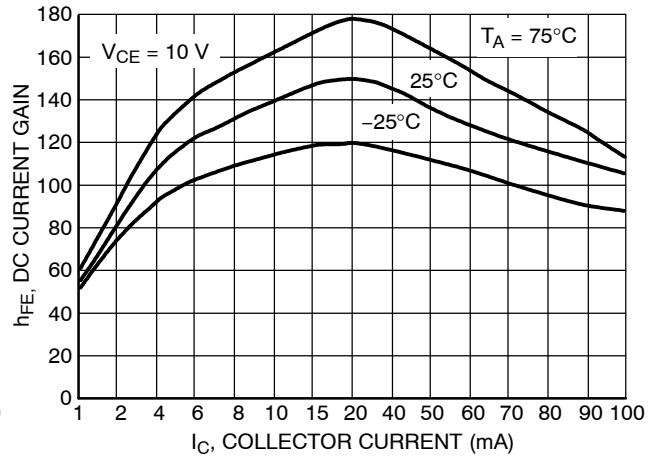

Figure 19. DC Current Gain

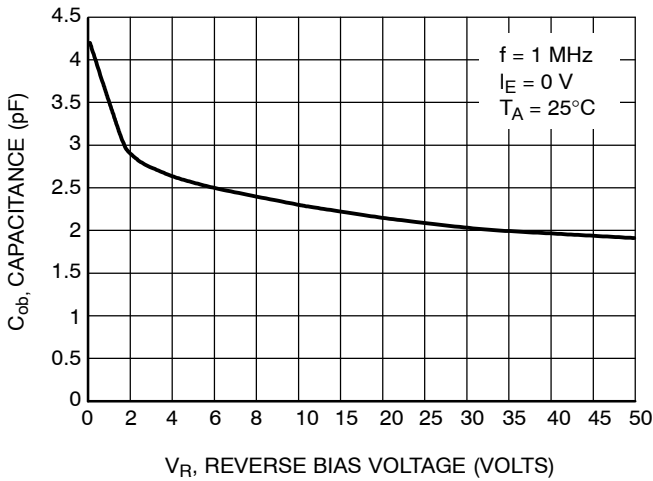

Figure 20. Output Capacitance

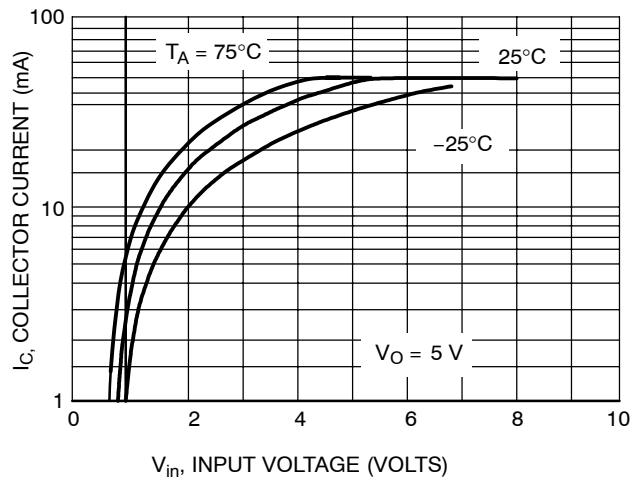

Figure 21. Output Current vs. Input Voltage

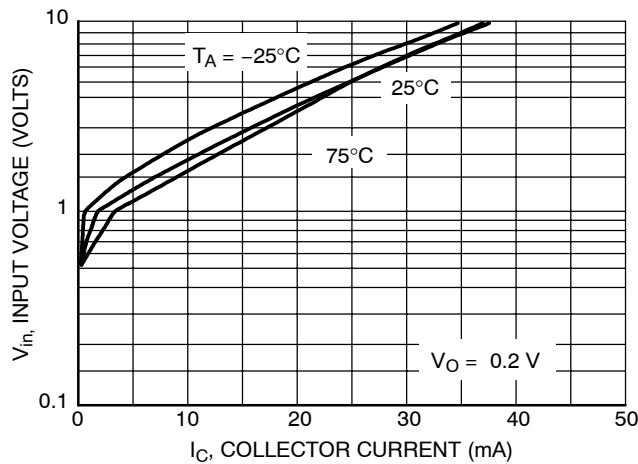

Figure 22. Input Voltage vs. Output Current

MUN2111T1 Series

TYPICAL ELECTRICAL CHARACTERISTICS – MUN2131T1

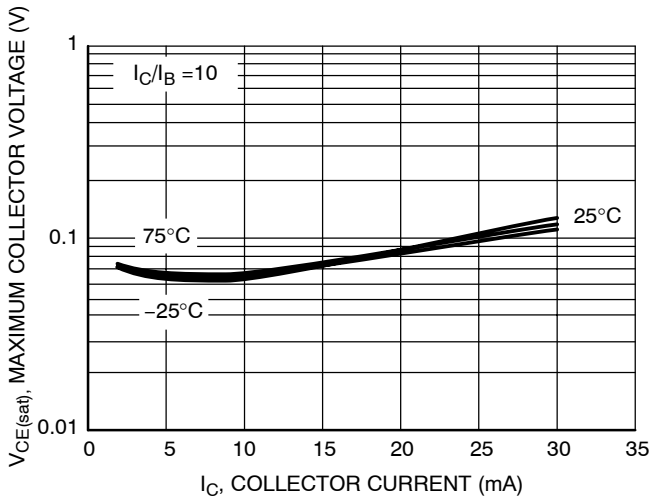

Figure 23. $V_{CE(sat)}$ vs. I_C

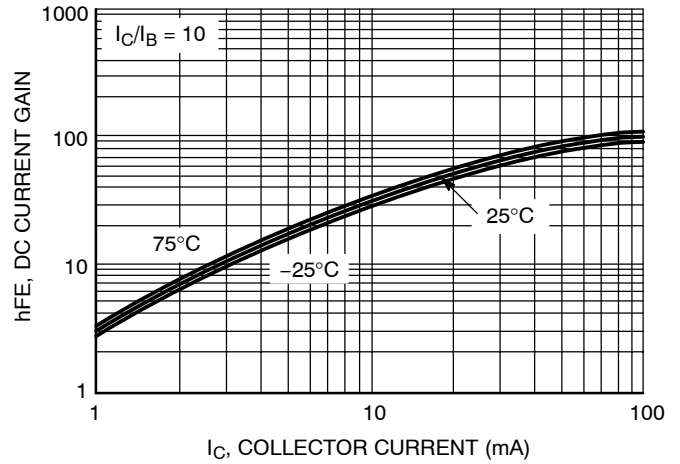

Figure 24. DC Current Gain

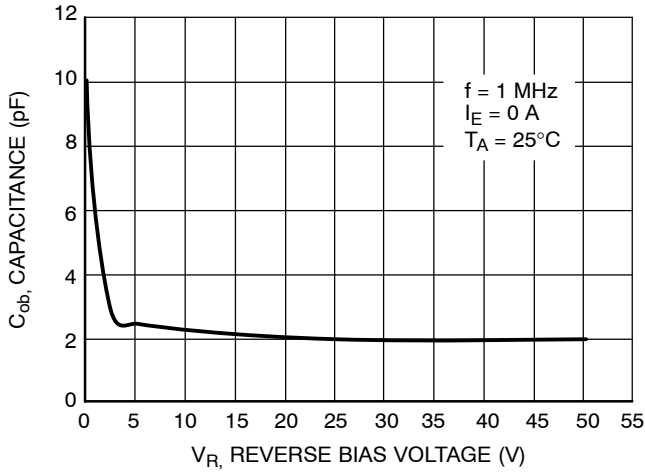

Figure 25. Output Capacitance

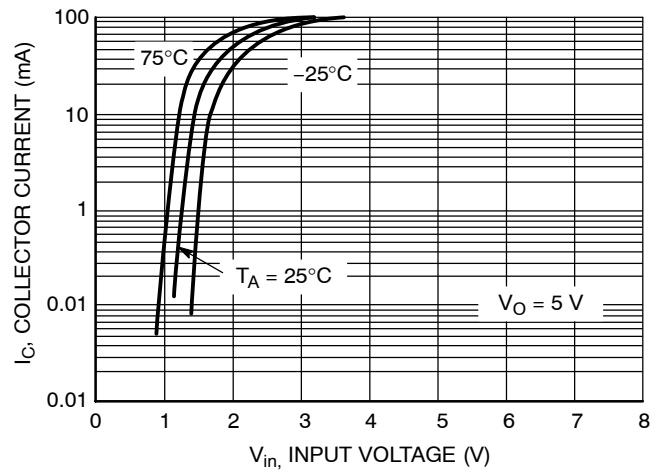

Figure 26. Output Current vs. Input Voltage

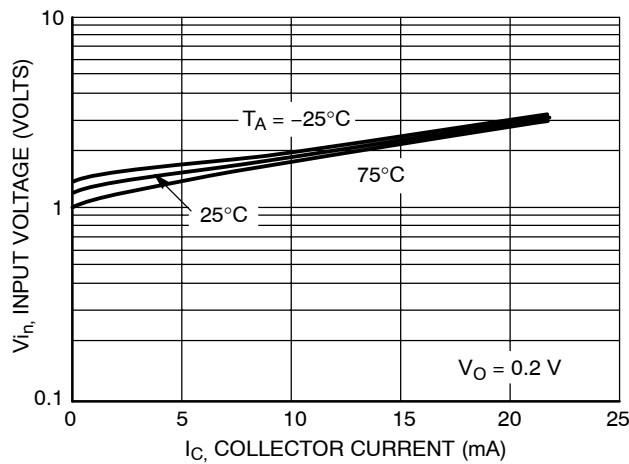

Figure 27. Input Voltage vs. Output Current

MUN2111T1 Series

TYPICAL ELECTRICAL CHARACTERISTICS — MUN2136T1

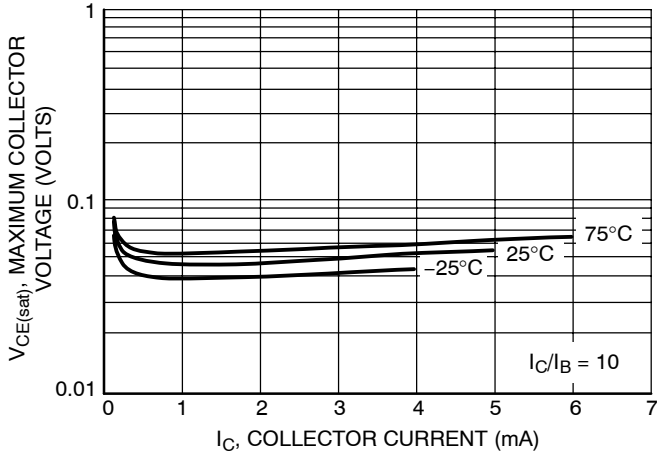

Figure 28. Maximum Collector Voltage vs. Collector Current

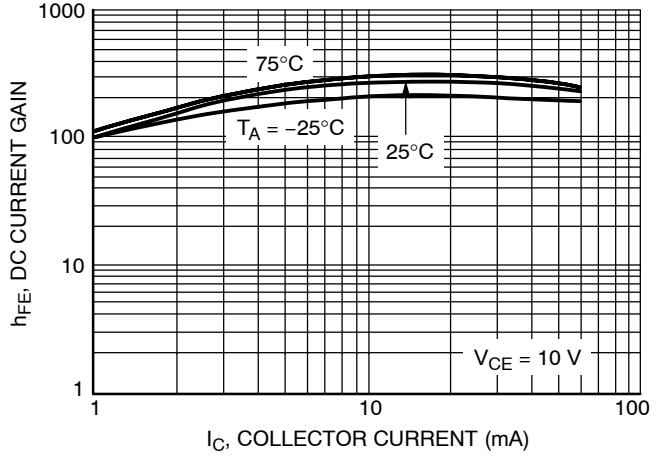

Figure 29. DC Current Gain

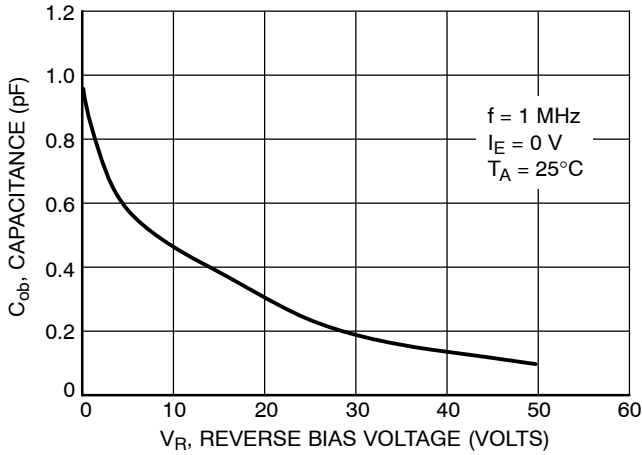

Figure 30. Output Capacitance

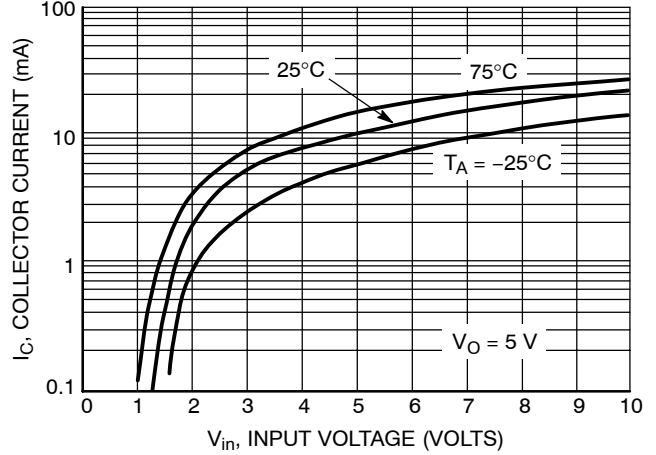

Figure 31. Output Current vs. Input Voltage

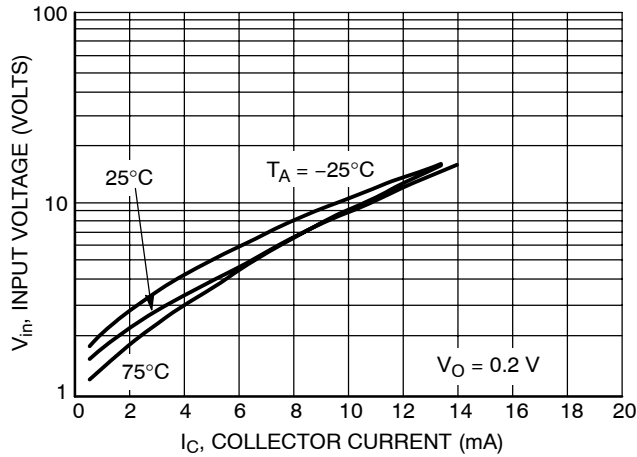

Figure 32. Input Voltage vs. Output Current

MUN2111T1 Series

TYPICAL ELECTRICAL CHARACTERISTICS — MUN2137T1

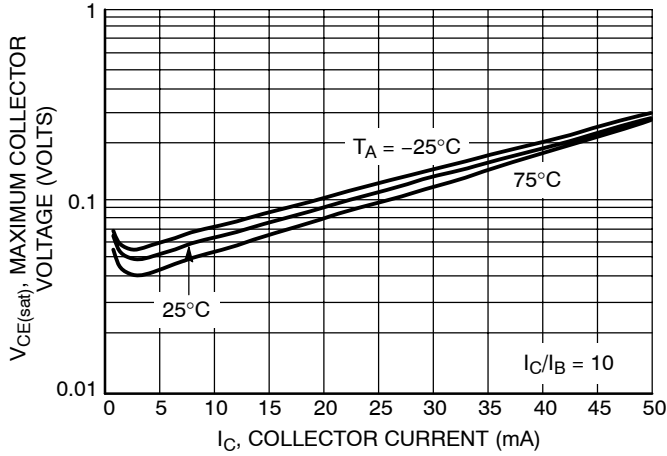

Figure 33. Maximum Collector Voltage vs. Collector Current

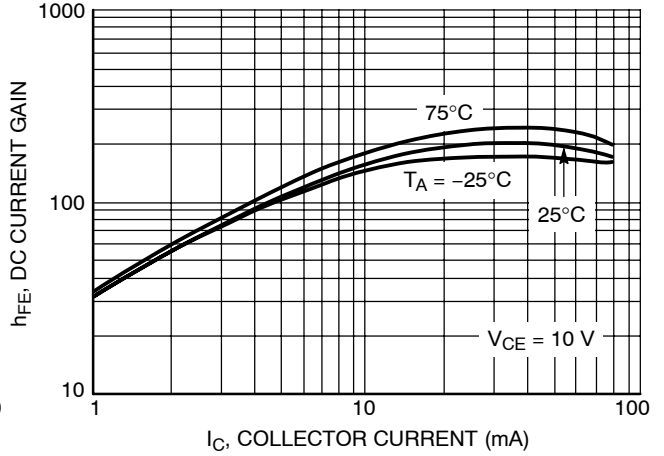

Figure 34. DC Current Gain

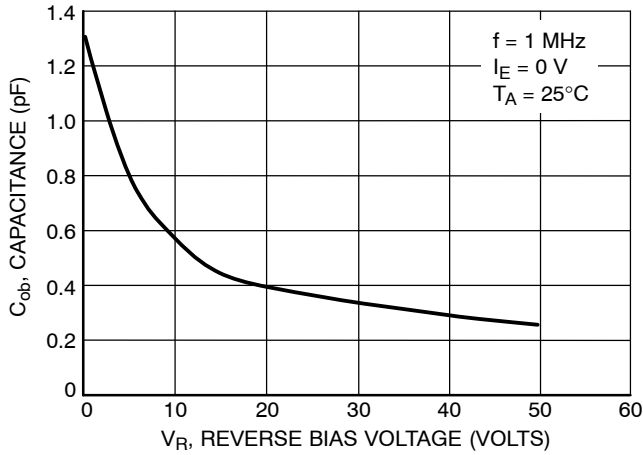

Figure 35. Output Capacitance

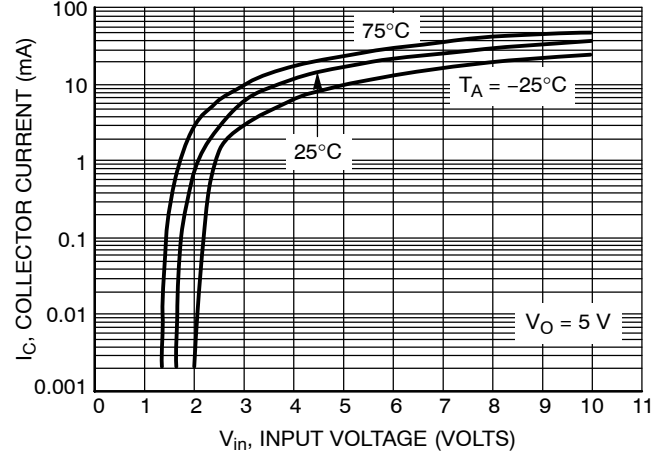

Figure 36. Output Current vs. Input Voltage

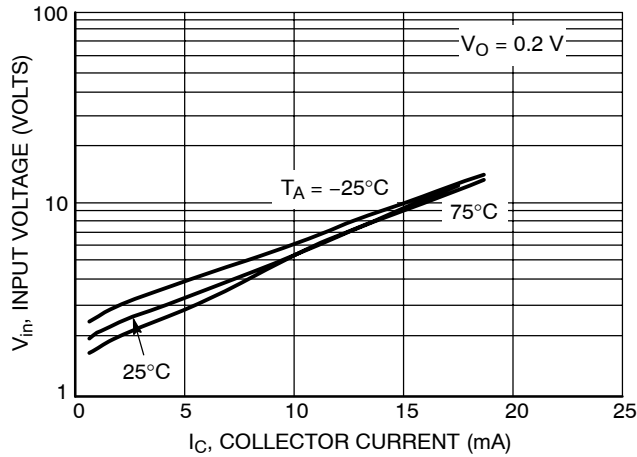
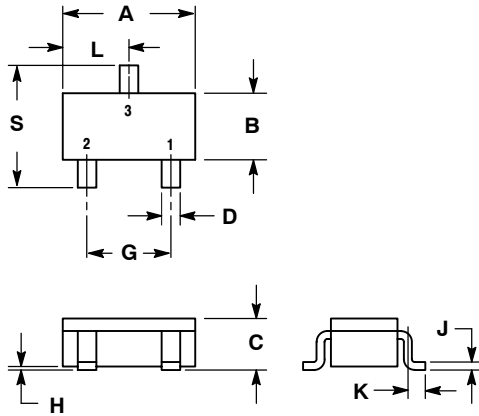

Figure 37. Input Voltage vs. Output Current

MUN2111T1 Series

PACKAGE DIMENSIONS

SC-59
CASE 318D-04
ISSUE F



NOTES:

1. DIMENSIONING AND TOLERANCING PER ANSI Y14.5M, 1982.
2. CONTROLLING DIMENSION: MILLIMETER.

DIM	MILLIMETERS		INCHES	
	MIN	MAX	MIN	MAX
A	2.70	3.10	0.1063	0.1220
B	1.30	1.70	0.0512	0.0669
C	1.00	1.30	0.0394	0.0511
D	0.35	0.50	0.0138	0.0196
G	1.70	2.10	0.0670	0.0826
H	0.013	0.100	0.0005	0.0040
J	0.09	0.18	0.0034	0.0070
K	0.20	0.60	0.0079	0.0236
L	1.25	1.65	0.0493	0.0649
S	2.50	3.00	0.0985	0.1181

STYLE 1:

- PIN 1. EMITTER
2. BASE
3. COLLECTOR

SOLDERING FOOTPRINT*

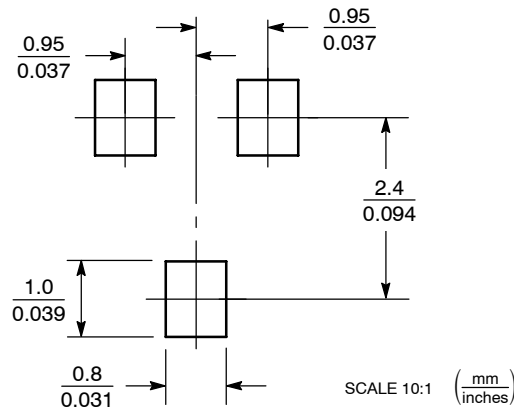

*For additional information on our Pb-Free strategy and soldering details, please download the ON Semiconductor Soldering and Mounting Techniques Reference Manual, SOLDERRM/D.

ON Semiconductor and  are registered trademarks of Semiconductor Components Industries, LLC (SCILLC). SCILLC reserves the right to make changes without further notice to any products herein. SCILLC makes no warranty, representation or guarantee regarding the suitability of its products for any particular purpose, nor does SCILLC assume any liability arising out of the application or use of any product or circuit, and specifically disclaims any and all liability, including without limitation special, consequential or incidental damages. "Typical" parameters which may be provided in SCILLC data sheets and/or specifications can and do vary in different applications and actual performance may vary over time. All operating parameters, including "Typicals" must be validated for each customer application by customer's technical experts. SCILLC does not convey any license under its patent rights nor the rights of others. SCILLC products are not designed, intended, or authorized for use as components in systems intended for surgical implant into the body, or other applications intended to support or sustain life, or for any other application in which the failure of the SCILLC product could create a situation where personal injury or death may occur. Should Buyer purchase or use SCILLC products for any such unintended or unauthorized application, Buyer shall indemnify and hold SCILLC and its officers, employees, subsidiaries, affiliates, and distributors harmless against all claims, costs, damages, and expenses, and reasonable attorney fees arising out of, directly or indirectly, any claim of personal injury or death associated with such unintended or unauthorized use, even if such claim alleges that SCILLC was negligent regarding the design or manufacture of the part. SCILLC is an Equal Opportunity/Affirmative Action Employer. This literature is subject to all applicable copyright laws and is not for resale in any manner.

PUBLICATION ORDERING INFORMATION

LITERATURE FULFILLMENT:
Literature Distribution Center for ON Semiconductor
P.O. Box 61312, Phoenix, Arizona 85082-1312 USA
Phone: 480-829-7710 or 800-344-3860 Toll Free USA/Canada
Fax: 480-829-7709 or 800-344-3867 Toll Free USA/Canada
Email: orderlit@onsemi.com

N. American Technical Support: 800-282-9855 Toll Free
USA/Canada

Japan: ON Semiconductor, Japan Customer Focus Center
2-9-1 Kamimeguro, Meguro-ku, Tokyo, Japan 153-0051
Phone: 81-3-5773-3850

ON Semiconductor Website: <http://onsemi.com>

Order Literature: <http://www.onsemi.com/litorder>

For additional information, please contact your local Sales Representative.