



4-BIT D LATCH

The TTL/MSI SN54/74LS75 and SN54/74LS77 are latches used as temporary storage for binary information between processing units and input/output or indicator units. Information present at a data (D) input is transferred to the Q output when the Enable is HIGH and the Q output will follow the data input as long as the Enable remains HIGH. When the Enable goes LOW, the information (that was present at the data input at the time the transition occurred) is retained at the Q output until the Enable is permitted to go HIGH.

The SN54/74LS75 features complementary Q and Q output from a 4-bit latch and is available in the 16-pin packages. For higher component density applications the SN54/74LS77 4-bit latch is available in the 14-pin package with Q outputs omitted.

CONNECTION DIAGRAMS DIP (TOP VIEW)

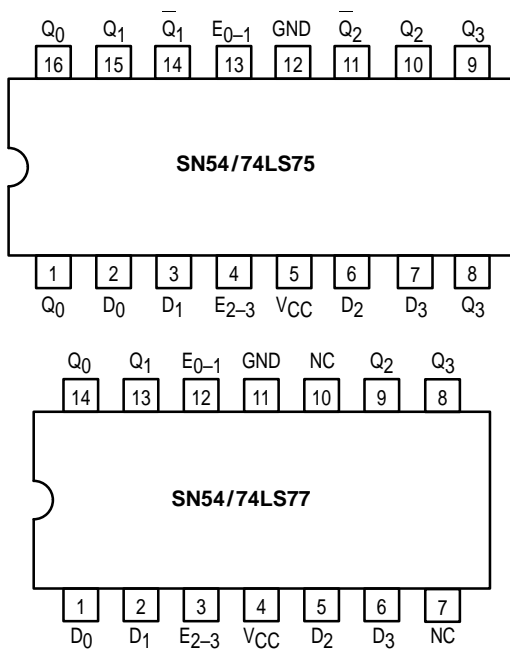

PIN NAMES

D ₁ -D ₄	Data Inputs
E ₀₋₁	Enable Input Latches 0, 1
E ₂₋₃	Enable Input Latches 2, 3
Q ₁ -Q ₄	Latch Outputs (Note b)
Q ₁ -Q ₄	Complimentary Latch Outputs (Note b)

LOADING (Note a)

	HIGH	LOW
D ₁ -D ₄	0.5 U.L.	0.25 U.L.
E ₀₋₁	2.0 U.L.	1.0 U.L.
E ₂₋₃	2.0 U.L.	1.0 U.L.
Q ₁ -Q ₄	10 U.L.	5 (2.5) U.L.
Q ₁ -Q ₄	10 U.L.	5 (2.5) U.L.

NOTES:

- a) 1 Unit Load (U.L.) = 40 μA HIGH.
- b) The Output LOW drive factor is 2.5 U.L. for Military (54) and 5 U.L. for Commercial (74) Temperature Ranges.

TRUTH TABLE (Each latch)

t _n	t _{n+1}
D	Q
H	H
L	L

NOTES:
 t_n = bit time before enable negative-going transition
 t_{n+1} = bit time after enable negative-going transition

SN54/74LS75 SN54/74LS77

4-BIT D LATCH LOW POWER SCHOTTKY

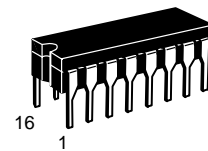

J SUFFIX
CERAMIC
CASE 620-09

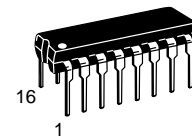

N SUFFIX
PLASTIC
CASE 648-08

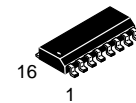

D SUFFIX
SOIC
CASE 751B-03

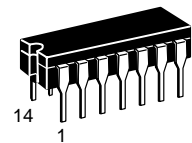

J SUFFIX
CERAMIC
CASE 632-08

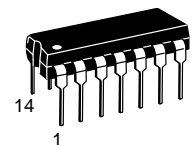

N SUFFIX
PLASTIC
CASE 646-06

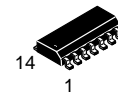

D SUFFIX
SOIC
CASE 751A-02

ORDERING INFORMATION

SN54LSXXJ	Ceramic
SN74LSXXN	Plastic
SN74LSXXD	SOIC

SN54/74LS75

LOGIC SYMBOLS

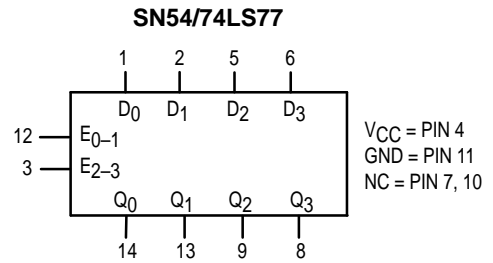
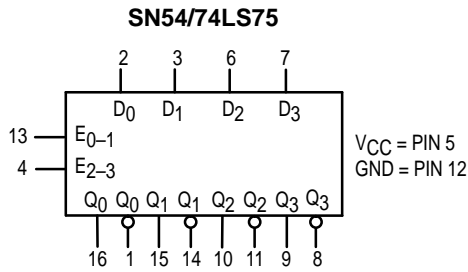

DC CHARACTERISTICS OVER OPERATING TEMPERATURE RANGE (unless otherwise specified)

Symbol	Parameter	Limits			Unit	Test Conditions	
		Min	Typ	Max			
V_{IH}	Input HIGH Voltage	2.0			V	Guaranteed Input HIGH Voltage for All Inputs	
V_{IL}	Input LOW Voltage	54		0.7	V	Guaranteed Input LOW Voltage for All Inputs	
		74		0.8			
V_{IK}	Input Clamp Diode Voltage		-0.65	-1.5	V	$V_{CC} = \text{MIN}$, $I_{IN} = -18 \text{ mA}$	
V_{OH}	Output HIGH Voltage	54	2.5	3.5	V	$V_{CC} = \text{MIN}$, $I_{OH} = \text{MAX}$, $V_{IN} = V_{IH}$ or V_{IL} per Truth Table	
		74	2.7	3.5	V		
V_{OL}	Output LOW Voltage	54, 74		0.25	0.4	V	$I_{OL} = 4.0 \text{ mA}$ $V_{CC} = V_{CC} \text{ MIN}$, $V_{IN} = V_{IL}$ or V_{IH} per Truth Table
		74		0.35	0.5	V	
I_{IH}	Input HIGH Current	D Input E Input			20 80	μA	$V_{CC} = \text{MAX}$, $V_{IN} = 2.7 \text{ V}$
					0.1 0.4	mA	$V_{CC} = \text{MAX}$, $V_{IN} = 7.0 \text{ V}$
I_{IL}	Input LOW Current	D Input E Input			-0.4 -1.6	mA	$V_{CC} = \text{MAX}$, $V_{IN} = 0.4 \text{ V}$
I_{OS}	Short Circuit Current (Note 1)		-20		-100	mA	$V_{CC} = \text{MAX}$
I_{CC}	Power Supply Current				12	mA	$V_{CC} = \text{MAX}$

Note 1: Not more than one output should be shorted at a time, nor for more than 1 second.

AC CHARACTERISTICS ($T_A = 25^\circ\text{C}$, $V_{CC} = 5.0 \text{ V}$)

Symbol	Parameter	Limits			Unit	Test Conditions
		Min	Typ	Max		
t_{PLH} t_{PHL}	Propagation Delay, Data to Q		15 9.0	27 17	ns	$V_{CC} = 5.0 \text{ V}$ $C_L = 15 \text{ pF}$
t_{PLH} t_{PHL}	Propagation Delay, Data to \bar{Q}		12 7.0	20 15	ns	
t_{PLH} t_{PHL}	Propagation Delay, Enable to Q		15 14	27 25	ns	
t_{PLH} t_{PHL}	Propagation Delay, Enable to \bar{Q}		16 7.0	30 15	ns	

SN54/74LS77

DC CHARACTERISTICS OVER OPERATING TEMPERATURE RANGE (unless otherwise specified)

Symbol	Parameter		Limits			Unit	Test Conditions	
			Min	Typ	Max			
V _{IH}	Input HIGH Voltage		2.0			V	Guaranteed Input HIGH Voltage for All Inputs	
V _{IL}	Input LOW Voltage	54			0.7	V	Guaranteed Input LOW Voltage for All Inputs	
		74			0.8			
V _{IK}	Input Clamp Diode Voltage			-0.65	-1.5	V	V _{CC} = MIN, I _{IN} = -18 mA	
V _{OH}	Output HIGH Voltage	54	2.5	3.5		V	V _{CC} = MIN, I _{OH} = MAX, V _{IN} = V _{IH} or V _{IL} per Truth Table	
		74	2.7	3.5		V		
V _{OL}	Output LOW Voltage	54, 74		0.25	0.4	V	I _{OL} = 4.0 mA	V _{CC} = V _{CC} MIN, V _{IN} = V _{IL} or V _{IH} per Truth Table
		74		0.35	0.5	V	I _{OL} = 8.0 mA	
I _{IH}	Input HIGH Current	D Input E Input			20 80	μA	V _{CC} = MAX, V _{IN} = 2.7 V	
		D Input E Input			0.1 0.4	mA	V _{CC} = MAX, V _{IN} = 7.0 V	
I _{IL}	Input LOW Current	D Input E Input			-0.4 -1.6	mA	V _{CC} = MAX, V _{IN} = 0.4 V	
I _{OS}	Short Circuit Current (Note 1)		-20		-100	mA	V _{CC} = MAX	
I _{CC}	Power Supply Current				13	mA	V _{CC} = MAX	

Note 1: Not more than one output should be shorted at a time, nor for more than 1 second.

AC CHARACTERISTICS (T_A = 25°C, V_{CC} = 5.0 V)

Symbol	Parameter		Limits			Unit	Test Conditions	
			Min	Typ	Max			
t _{PLH} t _{PHL}	Propagation Delay, Data to Q			11 9.0	19 17	ns	V _{CC} = 5.0 V C _L = 15 pF	
t _{PLH} t _{PHL}	Propagation Delay, Enable to Q			10 10	18 18	ns		

SN54/74LS75 • SN54/74LS77

LOGIC DIAGRAM

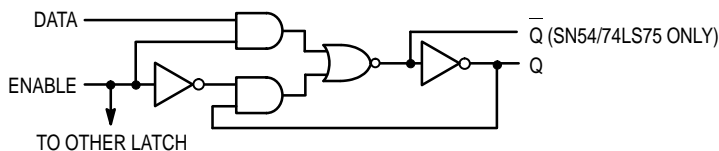

GUARANTEED OPERATING RANGES

Symbol	Parameter		Min	Typ	Max	Unit
V _{CC}	Supply Voltage	54	4.5	5.0	5.5	V
		74	4.75	5.0	5.25	
T _A	Operating Ambient Temperature Range	54	-55	25	125	°C
		74	0	25	70	
I _{OH}	Output Current — High	54, 74			-0.4	mA
I _{OL}	Output Current — Low	54			4.0	mA
		74			8.0	

AC SETUP REQUIREMENTS (T_A = 25°C, V_{CC} = 5.0 V)

Symbol	Parameter	Limits			Unit	Test Conditions
		Min	Typ	Max		
t _W	Enable Pulse Width High	20			ns	V _{CC} = 5.0 V
t _s	Setup Time	20			ns	
t _h	Hold Time	0			ns	

AC WAVEFORMS

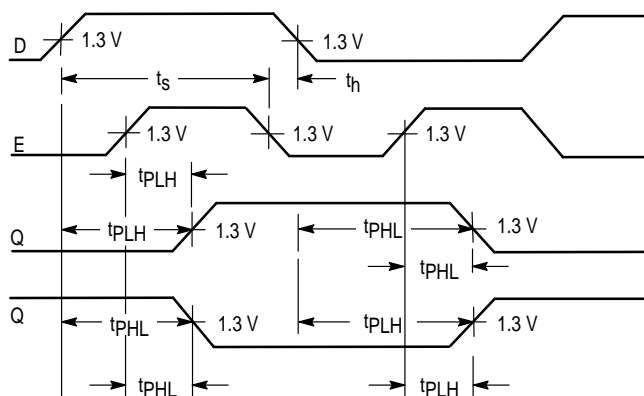

DEFINITION OF TERMS

SETUP TIME (t_s) — is defined as the minimum time required for the correct logic level to be present at the logic input prior to the clock transition from HIGH-to-LOW in order to be recognized and transferred to the outputs.

HOLD TIME (t_h) — is defined as the minimum time following the clock transition from HIGH-to-LOW that the logic level must be maintained at the input in order to ensure continued recognition. A negative HOLD TIME indicates that the correct logic level may be released prior to the clock transition from HIGH-to-LOW and still be recognized.