

# High Current Transistors

## NPN Silicon

**BC635**  
**BC637**  
**BC639**

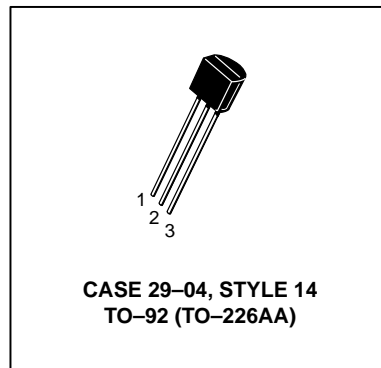
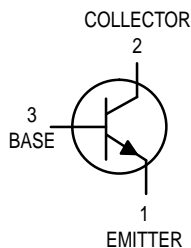

### MAXIMUM RATINGS

Rating	Symbol	BC 635	BC 637	BC 639	Unit
Collector–Emitter Voltage	$V_{CEO}$	45	60	80	Vdc
Collector–Base Voltage	$V_{CBO}$	45	60	80	Vdc
Emitter–Base Voltage	$V_{EBO}$	5.0			Vdc
Collector Current — Continuous	$I_C$	0.5			Adc
Total Device Dissipation @ $T_A = 25^\circ\text{C}$ Derate above $25^\circ\text{C}$	$P_D$	625 5.0			mW mW/°C
Total Device Dissipation @ $T_C = 25^\circ\text{C}$ Derate above $25^\circ\text{C}$	$P_D$	1.5 12			Watt mW/°C
Operating and Storage Junction Temperature Range	$T_J, T_{stg}$	–55 to +150			°C

### THERMAL CHARACTERISTICS

Characteristic	Symbol	Max	Unit
Thermal Resistance, Junction to Ambient	$R_{\theta JA}$	200	°C/W
Thermal Resistance, Junction to Case	$R_{\theta JC}$	83.3	°C/W

### ELECTRICAL CHARACTERISTICS ( $T_A = 25^\circ\text{C}$ unless otherwise noted)

Characteristic	Symbol	Min	Typ	Max	Unit
----------------	--------	-----	-----	-----	------

### OFF CHARACTERISTICS

Collector–Emitter Breakdown Voltage <sup>(1)</sup> ( $I_C = 10 \text{ mAdc}$ , $I_E = 0$ )	BC635 BC637 BC639	$V_{(BR)CEO}$	45 60 80	— — —	— — —	Vdc
Collector–Base Breakdown Voltage ( $I_C = 100 \mu\text{Adc}$ , $I_E = 0$ )	BC635 BC637 BC639	$V_{(BR)CBO}$	45 60 80	— — —	— — —	Vdc
Emitter–Base Breakdown Voltage ( $I_E = 10 \mu\text{Adc}$ , $I_C = 0$ )		$V_{(BR)EBO}$	5.0	—	—	Vdc
Collector Cutoff Current ( $V_{CB} = 30 \text{ Vdc}$ , $I_E = 0$ ) ( $V_{CB} = 30 \text{ Vdc}$ , $I_E = 0$ , $T_A = 125^\circ\text{C}$ )		$I_{CBO}$	— —	— —	100 10	nAdc $\mu\text{Adc}$

1. Pulse Test: Pulse Width  $\leq 300 \mu\text{s}$ , Duty Cycle 2.0%.

**BC635 BC637 BC639****ELECTRICAL CHARACTERISTICS** ( $T_A = 25^\circ\text{C}$  unless otherwise noted) (Continued)

Characteristic	Symbol	Min	Typ	Max	Unit
<b>ON CHARACTERISTICS<sup>(1)</sup></b>					
DC Current Gain ( $I_C = 5.0\text{ mA}$ , $V_{CE} = 2.0\text{ Vdc}$ ) ( $I_C = 150\text{ mA}$ , $V_{CE} = 2.0\text{ Vdc}$ )	$h_{FE}$	25	—	—	—
BC635		40	—	250	
BC637		40	—	160	
BC639		40	—	160	
( $I_C = 500\text{ mA}$ , $V_{CE} = 2.0\text{ V}$ )		25	—	—	
Collector–Emitter Saturation Voltage ( $I_C = 500\text{ mA}$ , $I_B = 50\text{ mA}$ )	$V_{CE(sat)}$	—	—	0.5	Vdc
Base–Emitter On Voltage ( $I_C = 500\text{ mA}$ , $V_{CE} = 2.0\text{ Vdc}$ )	$V_{BE(on)}$	—	—	1.0	Vdc
<b>DYNAMIC CHARACTERISTICS</b>					
Current–Gain — Bandwidth Product ( $I_C = 50\text{ mA}$ , $V_{CE} = 2.0\text{ Vdc}$ , $f = 100\text{ MHz}$ )	$f_T$	—	200	—	MHz
Output Capacitance ( $V_{CB} = 10\text{ Vdc}$ , $I_E = 0$ , $f = 1.0\text{ MHz}$ )	$C_{ob}$	—	7.0	—	pF
Input Capacitance ( $V_{EB} = 0.5\text{ Vdc}$ , $I_C = 0$ , $f = 1.0\text{ MHz}$ )	$C_{ib}$	—	50	—	pF

1. Pulse Test: Pulse Width  $\leq 300\ \mu\text{s}$ , Duty Cycle 2.0%.

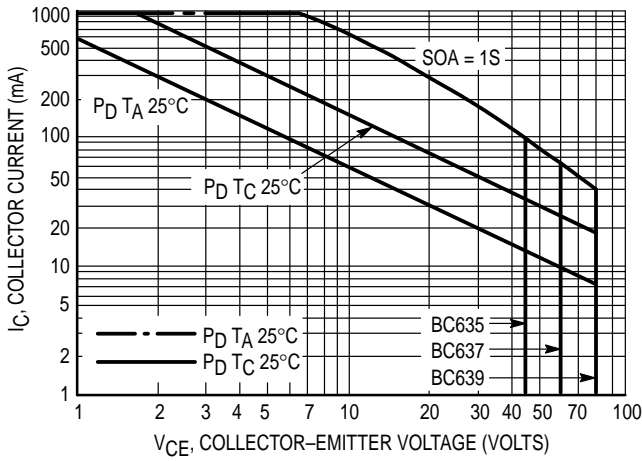

Figure 1. Active Region Safe Operating Area

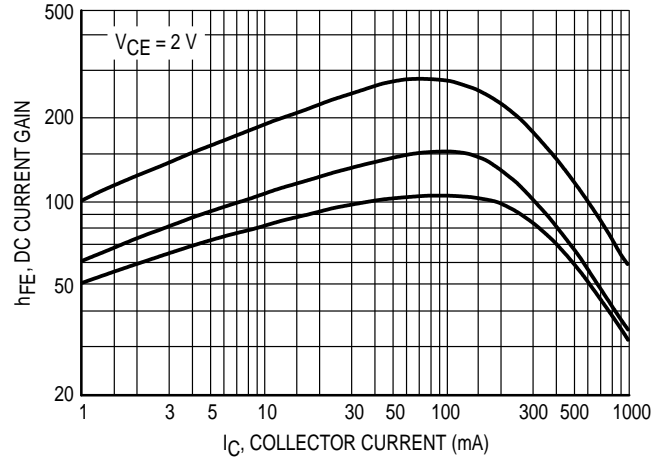

Figure 2. DC Current Gain

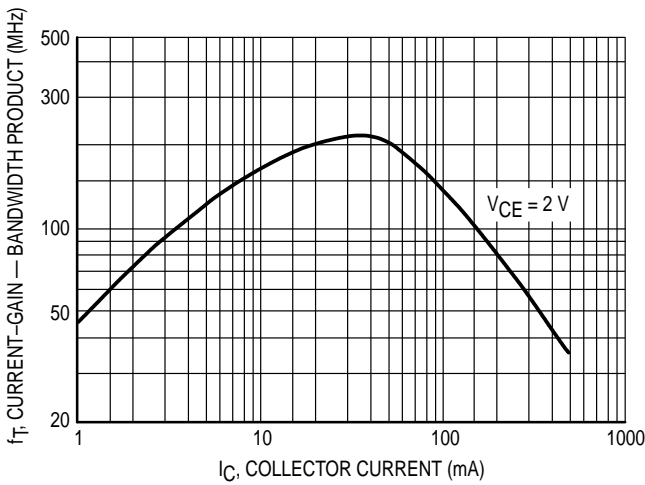

Figure 3. Current-Gain — Bandwidth Product

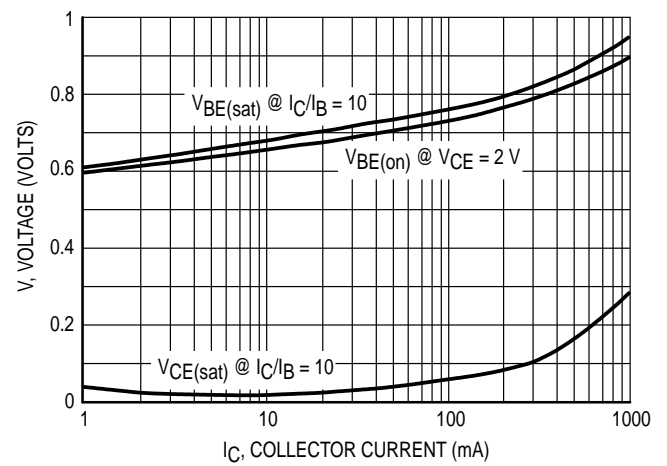

Figure 4. "Saturation" and "On" Voltages

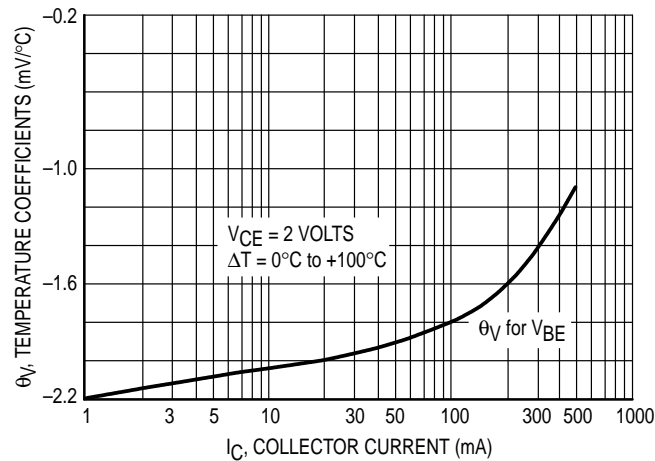

Figure 5. Temperature Coefficients

PACKAGE DIMENSIONS



CASE 029-04  
(TO-226AA)  
ISSUE AD

- NOTES:
1. DIMENSIONING AND TOLERANCING PER ANSI Y14.5M, 1982.
  2. CONTROLLING DIMENSION: INCH.
  3. CONTOUR OF PACKAGE BEYOND DIMENSION R IS UNCONTROLLED.
  4. DIMENSION F APPLIES BETWEEN P AND L. DIMENSION D AND J APPLY BETWEEN L AND K. MINIMUM LEAD DIMENSION IS UNCONTROLLED IN P AND BEYOND DIMENSION K MINIMUM.

DIM	INCHES		MILLIMETERS	
	MIN	MAX	MIN	MAX
A	0.175	0.205	4.45	5.20
B	0.170	0.210	4.32	5.33
C	0.125	0.165	3.18	4.19
D	0.016	0.022	0.41	0.55
F	0.016	0.019	0.41	0.48
G	0.045	0.055	1.15	1.39
H	0.095	0.105	2.42	2.66
J	0.015	0.020	0.39	0.50
K	0.500	—	12.70	—
L	0.250	—	6.35	—
N	0.080	0.105	2.04	2.66
P	—	0.100	—	2.54
R	0.115	—	2.93	—
V	0.135	—	3.43	—

- STYLE 14:  
PIN 1. EMITTER  
2. COLLECTOR  
3. BASE

Motorola reserves the right to make changes without further notice to any products herein. Motorola makes no warranty, representation or guarantee regarding the suitability of its products for any particular purpose, nor does Motorola assume any liability arising out of the application or use of any product or circuit, and specifically disclaims any and all liability, including without limitation consequential or incidental damages. "Typical" parameters can and do vary in different applications. All operating parameters, including "Typicals" must be validated for each customer application by customer's technical experts. Motorola does not convey any license under its patent rights nor the rights of others. Motorola products are not designed, intended, or authorized for use as components in systems intended for surgical implant into the body, or other applications intended to support or sustain life, or for any other application in which the failure of the Motorola product could create a situation where personal injury or death may occur. Should Buyer purchase or use Motorola products for any such unintended or unauthorized application, Buyer shall indemnify and hold Motorola and its officers, employees, subsidiaries, affiliates, and distributors harmless against all claims, costs, damages, and expenses, and reasonable attorney fees arising out of, directly or indirectly, any claim of personal injury or death associated with such unintended or unauthorized use, even if such claim alleges that Motorola was negligent regarding the design or manufacture of the part. Motorola and are registered trademarks of Motorola, Inc. Motorola, Inc. is an Equal Opportunity/Affirmative Action Employer.

How to reach us:

USA/EUROPE: Motorola Literature Distribution;  
P.O. Box 20912; Phoenix, Arizona 85036. 1-800-441-2447

JAPAN: Nippon Motorola Ltd.; Tatsumi-SPD-JLDC, Toshikatsu Otsuki,  
6F Seibu-Butsuryu-Center, 3-14-2 Tatsumi Koto-Ku, Tokyo 135, Japan. 03-3521-8315

MFAX: RMFAX0@email.sps.mot.com - TOUCHTONE (602) 244-6609  
INTERNET: http://Design-NET.com

HONG KONG: Motorola Semiconductors H.K. Ltd.; 8B Tai Ping Industrial Park,  
51 Ting Kok Road, Tai Po, N.T., Hong Kong. 852-26629298

