

Product Preview
Surface Mount
Schottky Power Rectifier
SMA Power Surface Mount Package

MBRA140T3

**SCHOTTKY BARRIER
RECTIFIER
1 AMPERES
40 VOLTS**



**CASE 403B-01
SMA**

... employing the Schottky Barrier principle in a large area metal-to-silicon power diode. State of the art geometry features epitaxial construction with oxide passivation and metal overlay contact. Ideally suited for low voltage, high frequency rectification, or as free wheeling and polarity diodes in surface mount applications where compact size and weight are critical to the system.

- Small Compact Surface Mountable Package with J-Bent Leads
- Rectangular Package for Automated Handling
- Highly Stable Oxide Passivated Junction
- Very Low Forward Voltage Drop
- Guardring for Stress Protection

Mechanical Characteristics:

- Case: Epoxy, Molded
- Weight: 70 mg (approximately)
- Finish: All External Surfaces Corrosion Resistant and Terminal Leads are Readily Solderable
- Lead and Mounting Surface Temperature for Soldering Purposes: 260°C Max. for 10 Seconds
- Shipped in 12 mm tape, 5000 units per 13 inch reel
- Polarity: Notch in Plastic Body Indicates Cathode Lead
- Marking: B4

MAXIMUM RATINGS

Rating	Symbol	Value	Unit
Peak Repetitive Reverse Voltage Working Peak Reverse Voltage DC Blocking Voltage	V_{RRM} V_{RWM} V_R	40	V
Average Rectified Forward Current (At Rated V_R , $T_C = 95^\circ\text{C}$)	I_O	1.0	A
Peak Repetitive Forward Current (At Rated V_R , Square Wave, 20 kHz, $T_C = 100^\circ\text{C}$)	I_{FRM}	2.0	A
Non-Repetitive Peak Surge Current (Surge applied at rated load conditions, halfwave, single phase, 60 Hz)	I_{FSM}	30	A
Storage/Operating Case Temperature	T_{stg}, T_C	-55 to +150	$^\circ\text{C}$
Operating Junction Temperature	T_J	-55 to +125	$^\circ\text{C}$
Voltage Rate of Change (Rated V_R , $T_J = 25^\circ\text{C}$)	dv/dt	10,000	V/ μs

THERMAL CHARACTERISTICS

Thermal Resistance — Junction-to-Lead (2)	R_{tjl}	35	$^\circ\text{C/W}$
Thermal Resistance — Junction-to-Ambient (2)	R_{tja}	86	

ELECTRICAL CHARACTERISTICS

Maximum Instantaneous Forward Voltage (1), see Figure 2 for other Values ($I_F = 1.0\text{ A}$) ($I_F = 2.0\text{ A}$)	V_F	$T_J = 25^\circ\text{C}$	$T_J = 100^\circ\text{C}$	V
		0.55 0.71	0.505 0.74	
Maximum Instantaneous Reverse Current, see Figure 4 for other Values ($V_R = 40\text{ V}$) ($V_R = 20\text{ V}$)	I_R	$T_J = 25^\circ\text{C}$	$T_J = 100^\circ\text{C}$	mA
		0.5 0.1	10 2.0	

This document contains information on a product under development. Motorola reserves the right to change or discontinue this product without notice.

(1) Pulse Test: Pulse Width $\leq 250\ \mu\text{s}$, Duty Cycle $\leq 2\%$.

(2) Mounted on 2" square pc board with 1" square total pad size, PC Board FR4.

REV 2

MBRA140T3

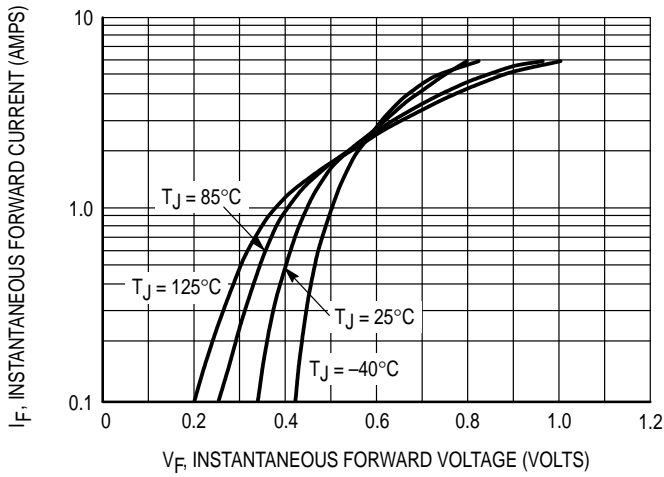

Figure 1. Typical Forward Voltage

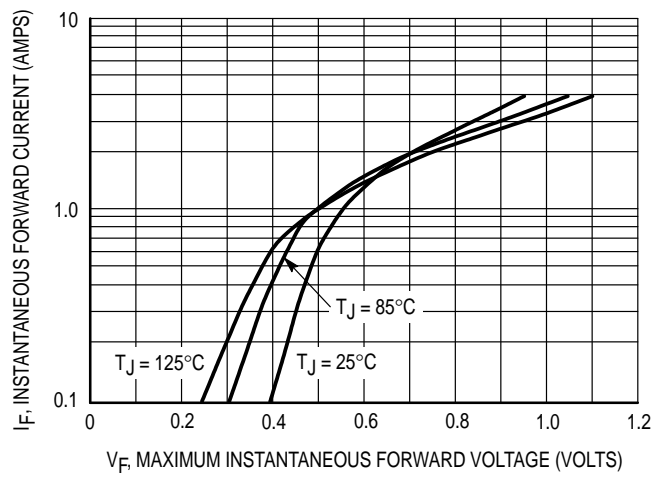

Figure 2. Maximum Forward Voltage

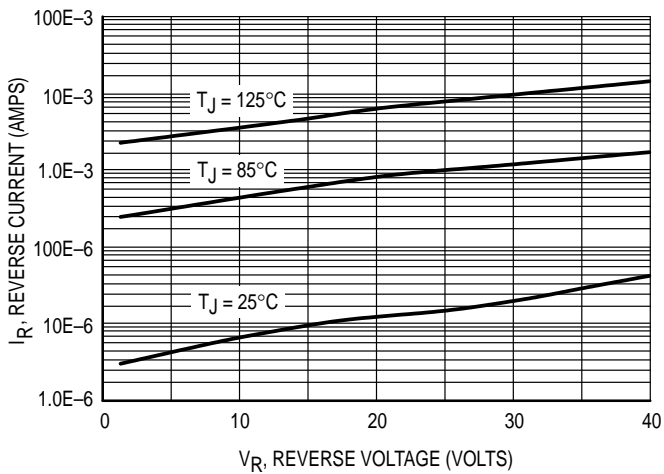

Figure 3. Typical Reverse Current

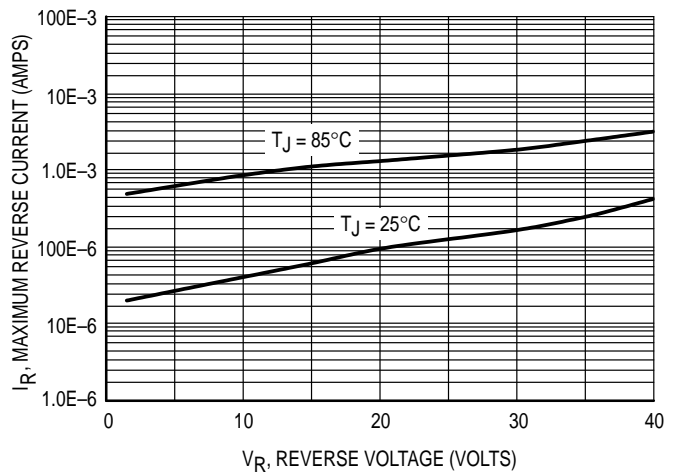

Figure 4. Maximum Reverse Current

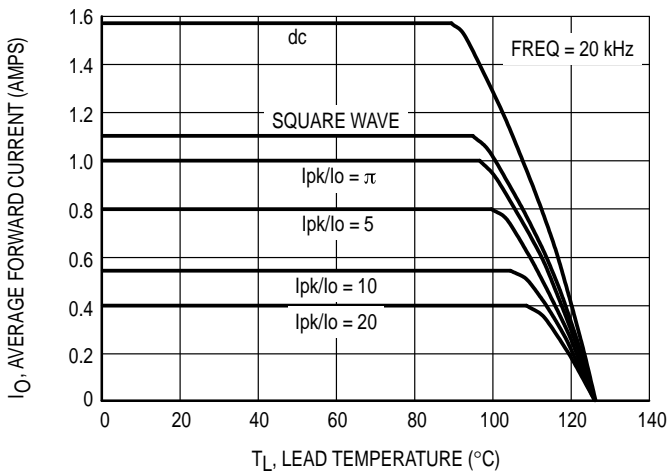

Figure 5. Current Derating

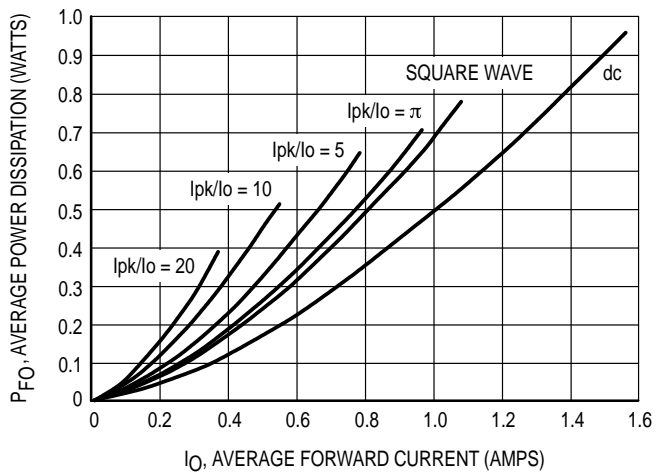

Figure 6. Forward Power Dissipation

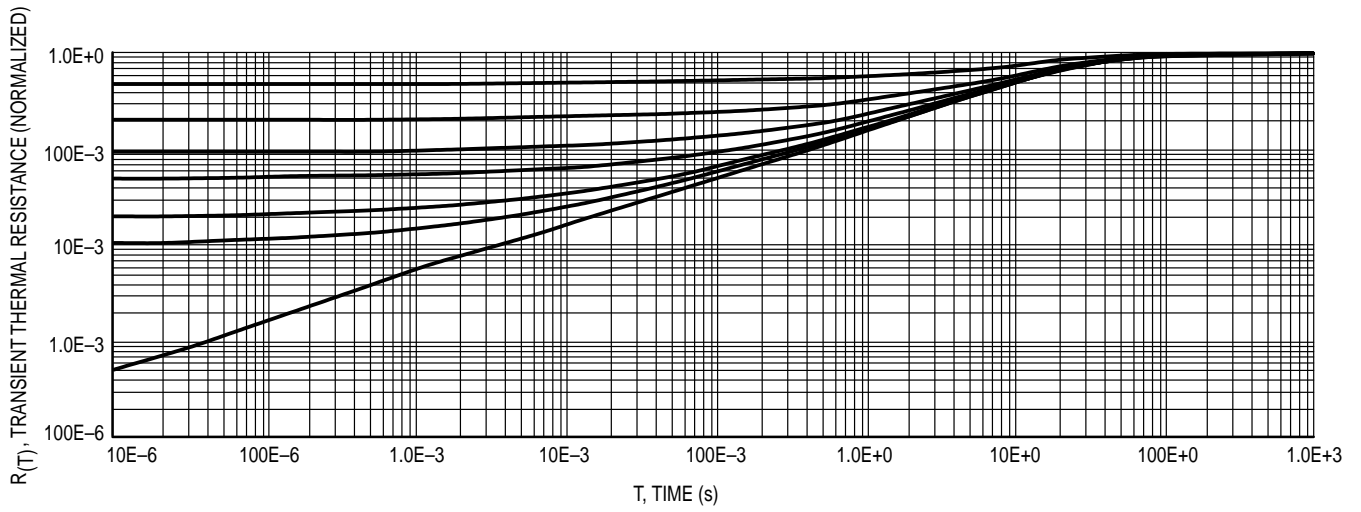

Figure 7. Thermal Response

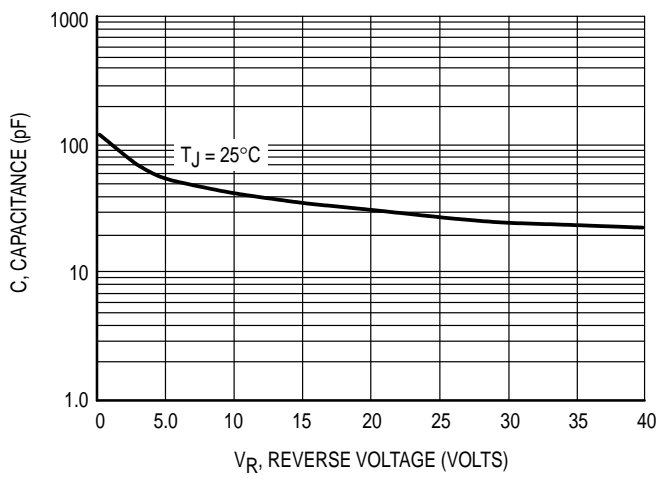
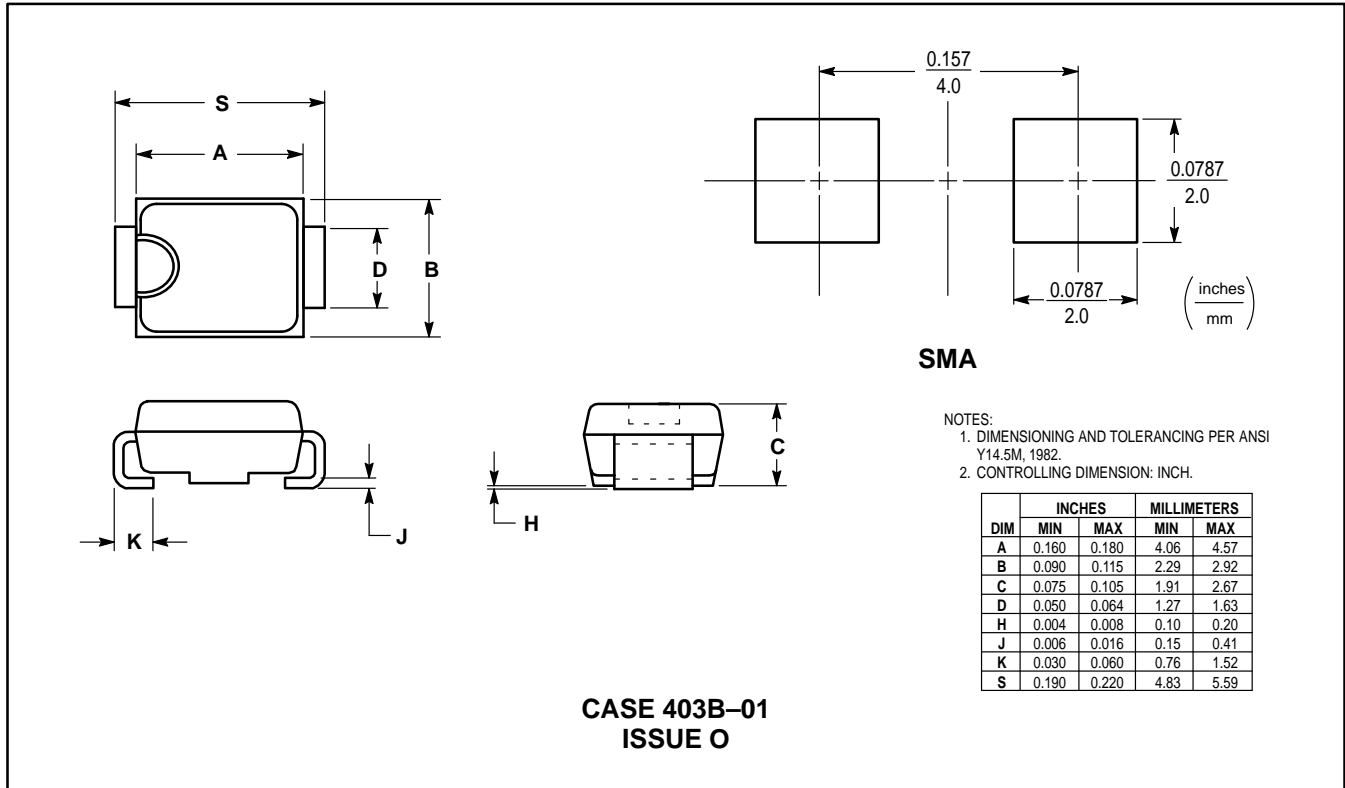

Figure 8. Capacitance

PACKAGE DIMENSIONS



Motorola reserves the right to make changes without further notice to any products herein. Motorola makes no warranty, representation or guarantee regarding the suitability of its products for any particular purpose, nor does Motorola assume any liability arising out of the application or use of any product or circuit, and specifically disclaims any and all liability, including without limitation consequential or incidental damages. "Typical" parameters which may be provided in Motorola data sheets and/or specifications can and do vary in different applications and actual performance may vary over time. All operating parameters, including "Typicals" must be validated for each customer application by customer's technical experts. Motorola does not convey any license under its patent rights nor the rights of others. Motorola products are not designed, intended, or authorized for use as components in systems intended for surgical implant into the body, or other applications intended to support or sustain life, or for any other application in which the failure of the Motorola product could create a situation where personal injury or death may occur. Should Buyer purchase or use Motorola products for any such unintended or unauthorized application, Buyer shall indemnify and hold Motorola and its officers, employees, subsidiaries, affiliates, and distributors harmless against all claims, costs, damages, and expenses, and reasonable attorney fees arising out of, directly or indirectly, any claim of personal injury or death associated with such unintended or unauthorized use, even if such claim alleges that Motorola was negligent regarding the design or manufacture of the part. Motorola and are registered trademarks of Motorola, Inc. Motorola, Inc. is an Equal Opportunity/Affirmative Action Employer.

How to reach us:

USA/EUROPE/Locations Not Listed: Motorola Literature Distribution; P.O. Box 20912; Phoenix, Arizona 85036. 1-800-441-2447 or 602-303-5454

MFAX: RMFAX0@email.sps.mot.com – TOUCHTONE 602-244-6609
INTERNET: http://Design-NET.com

JAPAN: Nippon Motorola Ltd.; Tatsumi-SPD-JLDC, 6F Seibu-Butsuryu-Center, 3-14-2 Tatsumi Koto-Ku, Tokyo 135, Japan. 03-81-3521-8315

ASIA/PACIFIC: Motorola Semiconductors H.K. Ltd.; 8B Tai Ping Industrial Park, 51 Ting Kok Road, Tai Po, N.T., Hong Kong. 852-26629298

