

Quad CMOS to PECL* Translator

The MC10H352 is a quad translator for interfacing data between a CMOS logic section and the PECL section of digital systems when only a +5.0 Vdc power supply is available. The MC10H352 has CMOS compatible inputs and PECL complementary open-emitter outputs that allow use as an inverting/non-inverting translator or as a differential line driver. When the common strobe input is at a low logic level, it forces all true outputs to the PECL low logic state ($\approx +3.2$ V) and all inverting outputs to the PECL high logic state ($\approx +4.1$ V).

The MC10H352 can also be used with the MC10H350 to transmit and receive CMOS information differentially via balanced twisted pair lines.

- Single +5.0 V Power Supply
- All V_{CC} Pins Isolated On Chip
- Differentially Drive Balanced Lines
- $t_{pd} = 1.3$ nsec Typical

MAXIMUM RATINGS

Characteristic	Symbol	Rating	Unit
Power Supply	V_{CC}	0 to +7.0	Vdc
Input Voltage ($V_{CC} = 5.0$ V)	V_I	0 to V_{CC}	Vdc
Output Current— Continuous — Surge	I_{out}	50 100	mA
Operating Temperature Range	T_A	0 to +75	°C
Storage Temperature Range— Plastic — Ceramic	T_{stg}	-55 to +150 -55 to +165	°C

ELECTRICAL CHARACTERISTICS ($V_{CC} = V_{CC1} = V_{CC2} = 5.0$ V \pm 5.0%)

Characteristic	Symbol	0°		25°		75°		Unit
		Min	Max	Min	Max	Min	Max	
Power Supply Current	ECL	—	50	—	45	—	50	mA
	TTL	—	20	—	15	—	20	mA
Reverse Current Pins 7, 8, 12, 14 Pin 9	I_R	—	25	—	20	—	25	μ A
		—	100	—	80	—	100	
Forward Current Pins 7, 8, 12, 14 Pin 9	I_F	—	-0.8	—	-0.6	—	-0.8	mA
		—	-3.2	—	-2.4	—	-3.2	
Input Voltage Breakdown	$V_{(BR)in}$	5.5	—	5.5	—	5.5	—	Vdc
Input Clamp Voltage ($I_{in} = -18$ mA)	V_I	—	-1.5	—	-1.5	—	-1.5	Vdc
High Output Voltage (1)	V_{OH}	3.98	4.16	4.02	4.19	4.08	4.27	Vdc
Low Output Voltage (1)	V_{OL}	3.05	3.37	3.05	3.37	3.05	3.37	Vdc
High Input Voltage	V_{IH}	3.15	—	3.15	—	3.15	—	Vdc
Low Input Voltage	V_{IL}	—	1.5	—	1.5	—	1.5	Vdc

(1) With V_{CC} at 5.0 V. V_{OH}/V_{OL} change 1:1 with V_{CC} .
*Positive Emitter Coupled Logic

MC10H352

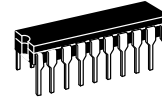

L SUFFIX
CERAMIC PACKAGE
CASE 732-03

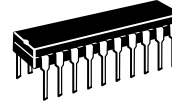

P SUFFIX
PLASTIC PACKAGE
CASE 738-03



FN SUFFIX
PLCC
CASE 775-02

LOGIC DIAGRAM

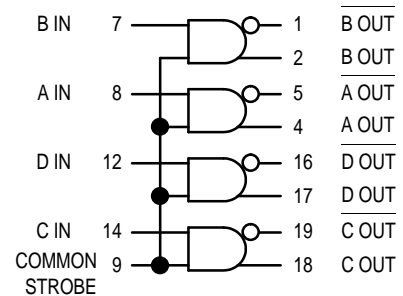

V_{CC} (+5.0 VDC) = PINS 6, 11, 15, 20
GND = PIN 10

DIP PIN ASSIGNMENT

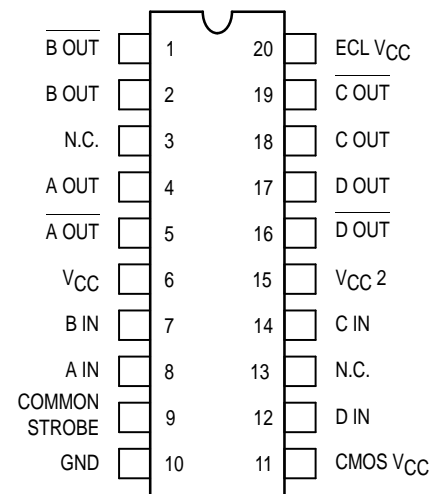

Pin assignment is for Dual-in-Line Package.
For PLCC pin assignment, see the Pin Conversion Tables on page 6-36 of the Motorola MECL Data Book (DL122/D).



AC PARAMETERS

Characteristic	Symbol	0°		25°		75°		Unit
		Min	Max	Min	Max	Min	Max	
Propagation Delay (1)	t_{pd}	0.4	1.9	0.4	2.0	0.4	2.1	ns
Rise Time (20% to 80%)	t_r	0.4	1.9	0.4	2.0	0.4	2.1	ns
Fall Time (80% to 20%)	t_f	0.4	1.9	0.4	2.0	0.4	2.1	ns
Maximum Operating Frequency	f_{max}	150	—	150	—	150	—	MHz

(1) Propagation delay is measured on this circuit from $V_{CC}/2$ on the input waveform to the 50% point on the output waveform.

NOTE:

Each MECL 10H series circuit has been designed to meet the dc specifications shown in the test table, after thermal equilibrium has been established. The circuit is in a test socket or mounted on a printed circuit board and transverse air flow greater than 500 lfpm is maintained. Outputs are terminated through a 50-ohm resistor to $V_{CC} - 2.0$ Vdc.

OUTLINE DIMENSIONS

FN SUFFIX
 PLASTIC PLCC PACKAGE
 CASE 775-02
 ISSUE C

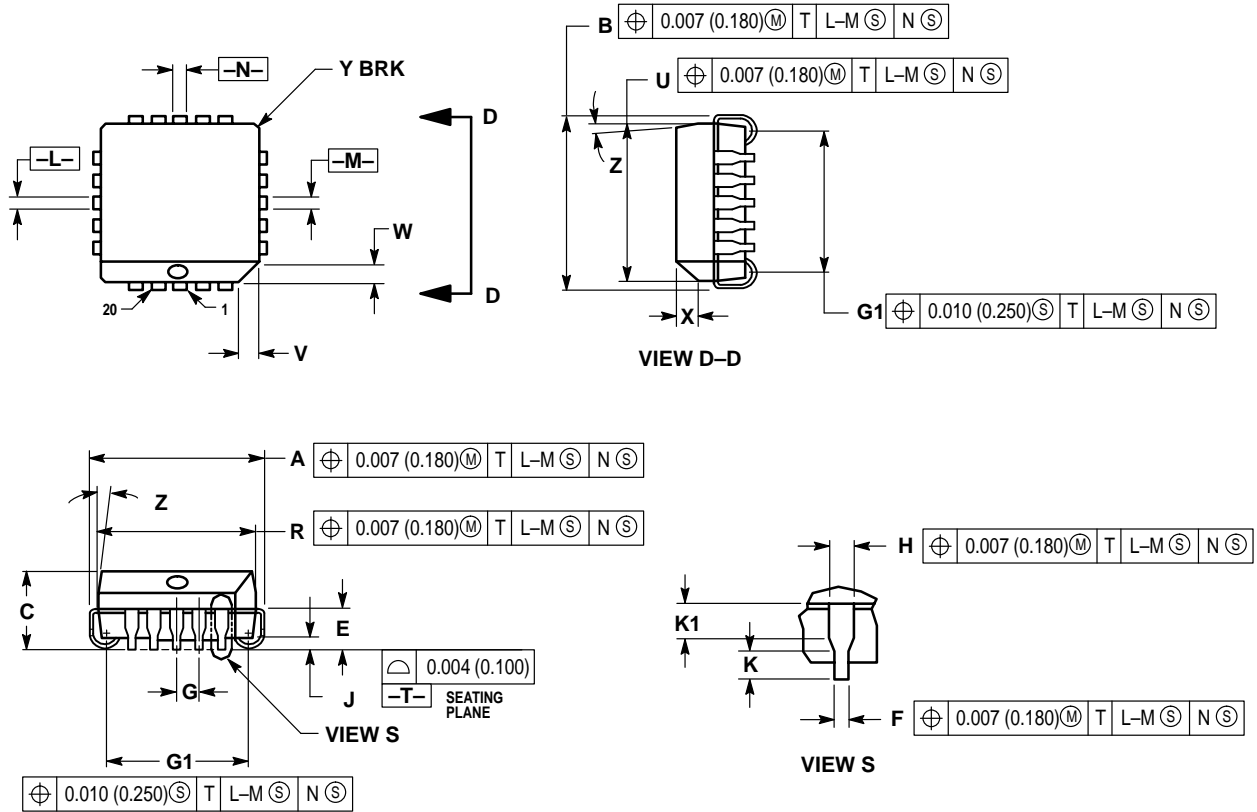

NOTES:

- DATUMS -L-, -M-, AND -N- DETERMINED WHERE TOP OF LEAD SHOULDER EXITS PLASTIC BODY AT MOLD PARTING LINE.
- DIMENSION G1, TRUE POSITION TO BE MEASURED AT DATUM -T-, SEATING PLANE.
- DIMENSIONS R AND U DO NOT INCLUDE MOLD FLASH. ALLOWABLE MOLD FLASH IS 0.010 (0.250) PER SIDE.
- DIMENSIONING AND TOLERANCING PER ANSI Y14.5M, 1982.
- CONTROLLING DIMENSION: INCH.
- THE PACKAGE TOP MAY BE SMALLER THAN THE PACKAGE BOTTOM BY UP TO 0.012 (0.300). DIMENSIONS R AND U ARE DETERMINED AT THE OUTERMOST EXTREMES OF THE PLASTIC BODY EXCLUSIVE OF MOLD FLASH, TIE BAR BURRS, GATE BURRS AND INTERLEAD FLASH, BUT INCLUDING ANY MISMATCH BETWEEN THE TOP AND BOTTOM OF THE PLASTIC BODY.
- DIMENSION H DOES NOT INCLUDE DAMBAR PROTRUSION OR INTRUSION. THE DAMBAR PROTRUSION(S) SHALL NOT CAUSE THE H DIMENSION TO BE GREATER THAN 0.037 (0.940). THE DAMBAR INTRUSION(S) SHALL NOT CAUSE THE H DIMENSION TO BE SMALLER THAN 0.025 (0.635).

DIM	INCHES		MILLIMETERS	
	MIN	MAX	MIN	MAX
A	0.385	0.395	9.78	10.03
B	0.385	0.395	9.78	10.03
C	0.165	0.180	4.20	4.57
E	0.090	0.110	2.29	2.79
F	0.013	0.019	0.33	0.48
G	0.050 BSC		1.27 BSC	
H	0.026	0.032	0.66	0.81
J	0.020	—	0.51	—
K	0.025	—	0.64	—
R	0.350	0.356	8.89	9.04
U	0.350	0.356	8.89	9.04
V	0.042	0.048	1.07	1.21
W	0.042	0.048	1.07	1.21
X	0.042	0.056	1.07	1.42
Y	—	0.020	—	0.50
Z	2°	10°	2°	10°
G1	0.310	0.330	7.88	8.38
K1	0.040	—	1.02	—

OUTLINE DIMENSIONS

L SUFFIX
CERAMIC DIP PACKAGE
 CASE 732-03
 ISSUE E

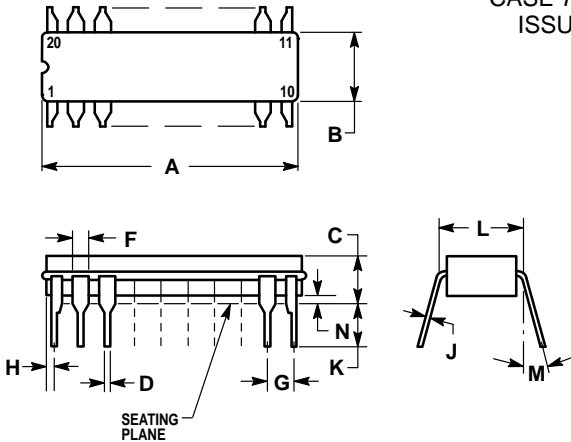

- NOTES:
- LEADS WITHIN 0.010 DIAMETER, TRUE POSITION AT SEATING PLANE, AT MAXIMUM MATERIAL CONDITION.
 - DIMENSION L TO CENTER OF LEADS WHEN FORMED PARALLEL.
 - DIMENSIONS A AND B INCLUDE MENISCUS.

DIM	INCHES	
	MIN	MAX
A	0.940	0.990
B	0.260	0.295
C	0.150	0.200
D	0.015	0.022
F	0.055	0.065
G	0.100 BSC	
H	0.020	0.050
J	0.008	0.012
K	0.125	0.160
L	0.300 BSC	
M	0° 15°	
N	0.010	0.040

P SUFFIX
PLASTIC DIP PACKAGE
 CASE 738-03
 ISSUE E

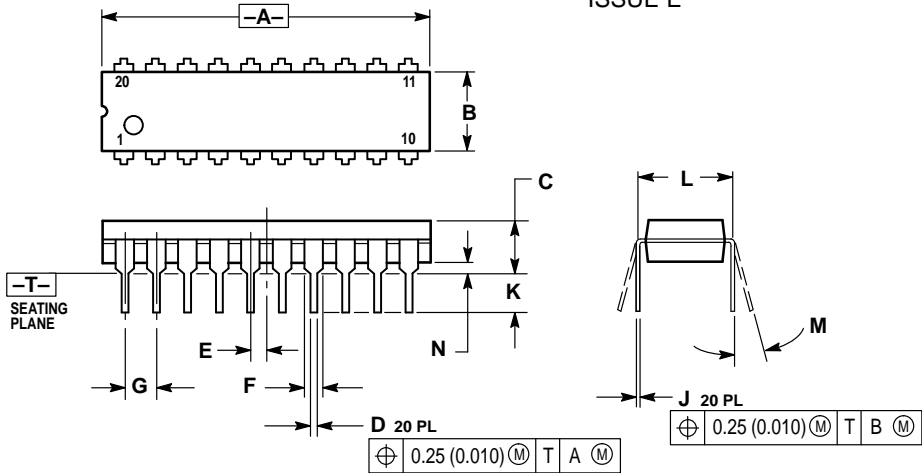

- NOTES:
- DIMENSIONING AND TOLERANCING PER ANSI Y14.5M, 1982.
 - CONTROLLING DIMENSION: INCH.
 - DIMENSION L TO CENTER OF LEAD WHEN FORMED PARALLEL.
 - DIMENSION B DOES NOT INCLUDE MOLD FLASH.

DIM	INCHES		MILLIMETERS	
	MIN	MAX	MIN	MAX
A	1.010	1.070	25.66	27.17
B	0.240	0.260	6.10	6.60
C	0.150	0.180	3.81	4.57
D	0.015	0.022	0.39	0.55
E	0.050 BSC		1.27 BSC	
F	0.050	0.070	1.27	1.77
G	0.100 BSC		2.54 BSC	
J	0.008	0.015	0.21	0.38
K	0.110	0.140	2.80	3.55
L	0.300 BSC		7.62 BSC	
M	0° 15°		0° 15°	
N	0.020	0.040	0.51	1.01

Motorola reserves the right to make changes without further notice to any products herein. Motorola makes no warranty, representation or guarantee regarding the suitability of its products for any particular purpose, nor does Motorola assume any liability arising out of the application or use of any product or circuit, and specifically disclaims any and all liability, including without limitation consequential or incidental damages. "Typical" parameters which may be provided in Motorola data sheets and/or specifications can and do vary in different applications and actual performance may vary over time. All operating parameters, including "Typicals" must be validated for each customer application by customer's technical experts. Motorola does not convey any license under its patent rights nor the rights of others. Motorola products are not designed, intended, or authorized for use as components in systems intended for surgical implant into the body, or other applications intended to support or sustain life, or for any other application in which the failure of the Motorola product could create a situation where personal injury or death may occur. Should Buyer purchase or use Motorola products for any such unintended or unauthorized application, Buyer shall indemnify and hold Motorola and its officers, employees, subsidiaries, affiliates, and distributors harmless against all claims, costs, damages, and expenses, and reasonable attorney fees arising out of, directly or indirectly, any claim of personal injury or death associated with such unintended or unauthorized use, even if such claim alleges that Motorola was negligent regarding the design or manufacture of the part. Motorola and $\text{\textcircled{M}}$ are registered trademarks of Motorola, Inc. Motorola, Inc. is an Equal Opportunity/Affirmative Action Employer.

How to reach us:
USA/EUROPE/Locations Not Listed: Motorola Literature Distribution;
 P.O. Box 20912; Phoenix, Arizona 85036. 1-800-441-2447 or 602-303-5454

JAPAN: Nippon Motorola Ltd.; Tatsumi-SPD-JLDC, 6F Seibu-Butsuryu-Center,
 3-14-2 Tatsumi Koto-Ku, Tokyo 135, Japan. 03-81-3521-8315

MFAX: RMFAX0@email.sps.mot.com – TOUCHTONE 602-244-6609
INTERNET: http://Design-NET.com

ASIA/PACIFIC: Motorola Semiconductors H.K. Ltd.; 8B Tai Ping Industrial Park,
 51 Ting Kok Road, Tai Po, N.T., Hong Kong. 852-26629298

