

MC33206 MC33207

Advance Information

Rail-To-Rail Operational Amplifiers with Enable Feature

The MC33206/7 family of operational amplifiers provide rail-to-rail operation on both the input and output. The inputs can be driven as high as 200 mV beyond the supply rails without phase reversal on the outputs and the output can swing within 50 mV of each rail. This rail-to-rail operation enables the user to make full use of the supply voltage range available. It is designed to work at very low supply voltages (± 0.9 V) yet can operate with a single supply of up to 12 V and ground. Output current boosting techniques provide a high output current capability while keeping the drain current of the amplifier to a minimum.

The MC33206/7 has an enable mode that can be controlled externally. The typical supply current in the standby mode is $<1.0 \mu\text{A}$ ($V_{\text{Enable}} = \text{Gnd}$). The addition of an enable function makes this amplifier an ideal choice for power sensitive applications, battery powered equipment (instrumentation and monitoring), portable telecommunication, and sample-and-hold applications.

- Standby Mode ($I_D \leq 1.0 \mu\text{A}$, Typ)
- Low Voltage, Single Supply Operation (1.8 V and Ground to 12 V and Ground)
- Rail-to-Rail Input Common Mode Voltage Range
- Output Voltage Swings within 50 mV of both Rails
- No Phase Reversal on the Output for Over-Driven Input Signals
- High Output Current ($I_{\text{SC}} = 80 \text{ mA}$, Typ)
- Low Supply Current ($I_D = 0.9 \text{ mA}$, Typ)
- 600 Ω Output Drive Capability
- Typical Gain Bandwidth Product = 2.2 MHz

ORDERING INFORMATION

Operational Amplifier Function	Device	Operating Temperature Range	Package
Dual	MC33206D	$T_A = -40^\circ \text{ to } +105^\circ\text{C}$	SO-14
	MC33206P		Plastic DIP
Quad	MC33207D		SO-16
	MC33207P		Plastic DIP

LOW VOLTAGE RAIL-TO-RAIL OPERATIONAL AMPLIFIERS

SEMICONDUCTOR TECHNICAL DATA

MC33206

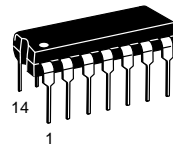

P SUFFIX
PLASTIC PACKAGE
CASE 646

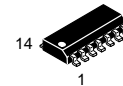

D SUFFIX
PLASTIC PACKAGE
CASE 751A
(SO-14)

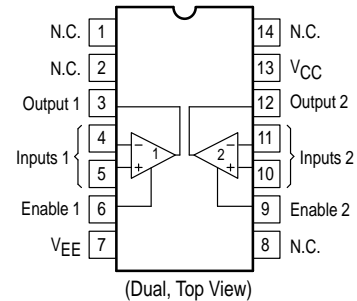

MC33207

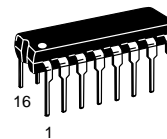

P SUFFIX
PLASTIC PACKAGE
CASE 648

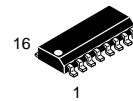

D SUFFIX
PLASTIC PACKAGE
CASE 751B
(SO-16)

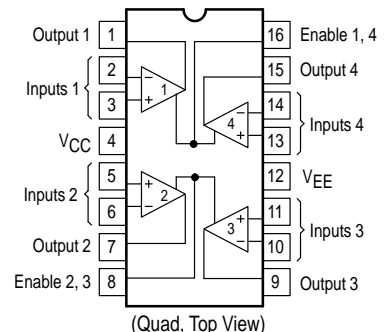

MC33206 MC33207

MAXIMUM RATINGS

Rating	Symbol	Value	Unit
Supply Voltage (V_{CC} to V_{EE})	V_S	13	V
ESD Protection Voltage at any Pin Human Body Model	V_{ESD}	2,000	V
Voltage at any Device Pin	V_{DP}	$V_S \pm 0.5$	V
Input Differential Voltage Range	V_{IDR}	(Note 1)	V
Common Mode Input Voltage Range (Note 2)	V_{CM}	$V_{CC} + 0.5$ to $V_{EE} - 0.5$	V
Output Short Circuit Duration (Note 3)	t_s	(Note 3)	sec
Maximum Junction Temperature	T_J	+150	°C
Storage Temperature Range	T_{stg}	-65 to +150	°C
Maximum Power Dissipation	P_D	(Note 3)	mW

- NOTES:**
1. The differential input voltage of each amplifier is limited by two internal parallel back-to-back diodes. For additional differential input voltage range, use current limiting resistors in series with the input pins.
 2. The common-mode input voltage range of each amplifier is limited by diodes connected from the inputs to both power supply rails. Therefore, the voltage on either input must not exceed either supply rail by more than 500 mV.
 3. Power dissipation must be considered to ensure maximum junction temperature (T_J) is not exceeded.
 4. ESD data available upon request.

DC ELECTRICAL CHARACTERISTICS ($V_{CC} = 5.0$ V, $V_{EE} = 0$ V, $V_{Enable} = 5.0$ V, $T_A = 25^\circ\text{C}$, unless otherwise noted.)

Characteristic	Figure	Symbol	Min	Typ	Max	Unit
Input Offset Voltage ($V_{CM} = 0$ to 0.5 V, $V_{CM} = 1.0$ to 5.0 V) MC33206: $T_A = 25^\circ\text{C}$ $T_A = -40^\circ$ to $+105^\circ\text{C}$ MC33207: $T_A = 25^\circ\text{C}$ $T_A = -40^\circ$ to $+105^\circ\text{C}$	–	V_{IO}	–	0.5 1.0 0.5 1.0	8.0 11 10 13	mV
Input Offset Voltage Temperature Coefficient ($R_S = 50 \Omega$) $T_A = -40^\circ$ to $+105^\circ\text{C}$	–	$\Delta V_{IO}/\Delta T$	–	2.0	–	$\mu\text{V}/^\circ\text{C}$
Input Bias Current ($V_{CM} = 0$ to 0.5 V, $V_{CM} = 1.0$ to 5.0 V) $T_A = 25^\circ\text{C}$ $T_A = -40^\circ$ to $+105^\circ\text{C}$	–	$ I_{IB} $	–	80 100	200 250	nA
Input Offset Current ($V_{CM} = 0$ to 0.5 V, $V_{CM} = 1.0$ to 5.0 V) $T_A = 25^\circ\text{C}$ $T_A = -40^\circ$ to $+105^\circ\text{C}$	–	$ I_{IO} $	–	5.0 10	50 100	nA
Common Mode Input Voltage Range	–	V_{ICR}	– V_{EE}	$V_{CC} + 0.2$ $V_{EE} - 0.2$	V_{CC} –	V
Large Signal Voltage Gain ($V_{CC} = 5.0$ V, $V_{EE} = -5.0$ V) $R_L = 10 \text{ k}\Omega$ $R_L = 600 \Omega$	–	A_{VOL}	50 25	300 250	– –	kV/V
Output Voltage Swing ($V_{ID} = \pm 0.2$ V) $R_L = 10 \text{ k}\Omega$ $R_L = 10 \text{ k}\Omega$ $R_L = 600 \Omega$ $R_L = 600 \Omega$	–	V_{OH} V_{OL} V_{OH} V_{OL}	4.85 – 4.75 –	4.95 0.05 4.85 0.15	– 0.15 – 0.25	V
Common Mode Rejection ($V_{in} = 0$ to 5.0 V)	–	CMR	60	90	–	dB
Power Supply Rejection Ratio $V_{CC}/V_{EE} = 5.0$ V/Gnd to 3.0 V/Gnd	–	PSRR PSR	– 66	25 92	500 –	$\mu\text{V}/\text{V}$ dB
Output Short Circuit Current (Source and Sink)	–	I_{SC}	50	80	–	mA

MC33206 MC33207

DC ELECTRICAL CHARACTERISTICS (continued) ($V_{CC} = 5.0\text{ V}$, $V_{EE} = 0\text{ V}$, $V_{Enable} = 5.0\text{ V}$, $T_A = 25^\circ\text{C}$, unless otherwise noted.)

Characteristic	Figure	Symbol	Min	Typ	Max	Unit
Power Supply Current ($V_O = 2.5\text{ V}$, $T_A = -40^\circ$ to $+105^\circ\text{C}$, per Amplifier) MC33206: $V_{Enable} = 5.0\text{ Vdc}$ $V_{Enable} = \text{Gnd (Standby)}$ MC33207: $V_{Enable} = 5.0\text{ Vdc}$ $V_{Enable} = \text{Gnd (Standby)}$	–	I_D	–	0.8 0.5 1.5 0.5	1.125 6.0 2.25 6.0	mA μA mA μA
Enable Input Voltage (per Amplifier) Enabled – Amplifier “On” Disabled – Amplifier “Off” (Standby)	–	V_{Enable}	–	$V_{EE} + 1.8$ $V_{EE} + 0.3$	– –	V
Enable Input Current (Note 5) (per Amplifier) $V_{Enable} = 12\text{ V}$ $V_{Enable} = 5.0\text{ V}$ $V_{Enable} = 1.8\text{ V}$ $V_{Enable} = \text{Gnd}$	–	I_{Enable}	–	2.5 2.2 0.8 0	– – – –	μA

NOTE: 5. External control circuitry must provide for an initial turn-off transient of $<10\ \mu\text{A}$.

AC ELECTRICAL CHARACTERISTICS ($V_{CC} = 5.0\text{ V}$, $V_{EE} = 0\text{ V}$, $V_{Enable} = 5.0\text{ V}$, $T_A = 25^\circ\text{C}$, unless otherwise noted.)

Characteristic	Figure	Symbol	Min	Typ	Max	Unit
Slew Rate ($V_S = \pm 2.5\text{ V}$, $V_O = -2.0$ to $+2.0\text{ V}$, $R_L = 2.0\text{ k}\Omega$, $A_V = 1.0$)	–	SR	0.5	1.0	–	V/ μs
Gain Bandwidth Product ($f = 100\text{ kHz}$)	–	GBW	–	2.2	–	MHz
Phase Margin ($R_L = 600\ \Omega$, $C_L = 0\text{ pF}$)	–	ϕ_M	–	65	–	Deg
Gain Margin ($R_L = 600\ \Omega$, $C_L = 0\text{ pF}$)	–	A_M	–	12	–	dB
Channel Separation ($f = 1.0\text{ Hz}$ to 20 kHz , $A_V = 100$)	–	CS	–	90	–	dB
Power Bandwidth ($V_O = 4.0\text{ Vpp}$, $R_L = 600\ \Omega$, THD $\leq 1\%$)	–	BWP	–	28	–	kHz
Total Harmonic Distortion ($R_L = 600\ \Omega$, $V_O = 1.0\text{ Vpp}$, $A_V = 1.0$) $f = 1.0\text{ kHz}$ $f = 10\text{ kHz}$	–	THD	–	0.002 0.008	– –	%
Open Loop Output Impedance ($V_O = 0\text{ V}$, $f = 2.0\text{ MHz}$, $A_V = 10$)	–	$ Z_O $	–	100	–	Ω
Differential Input Resistance ($V_{CM} = 0\text{ V}$)	–	R_{in}	–	200	–	k Ω
Differential Input Capacitance ($V_{CM} = 0\text{ V}$)	–	C_{in}	–	8.0	–	pF
Equivalent Input Noise Voltage ($R_S = 100\ \Omega$) $f = 10\text{ Hz}$ $f = 1.0\text{ kHz}$	–	e_n	–	25 20	– –	nV/ $\sqrt{\text{Hz}}$
Equivalent Input Noise Current $f = 10\text{ Hz}$ $f = 1.0\text{ kHz}$	–	i_n	–	0.8 0.2	– –	pA/ $\sqrt{\text{Hz}}$
Time Delay for Device to Turn On	–	t_{on}	–	10	–	μs
Time Delay for Device to Turn Off	–	t_{off}	–	2.0	–	μs

MC33206 MC33207

Figure 1. Circuit Schematic
(Each Amplifier)

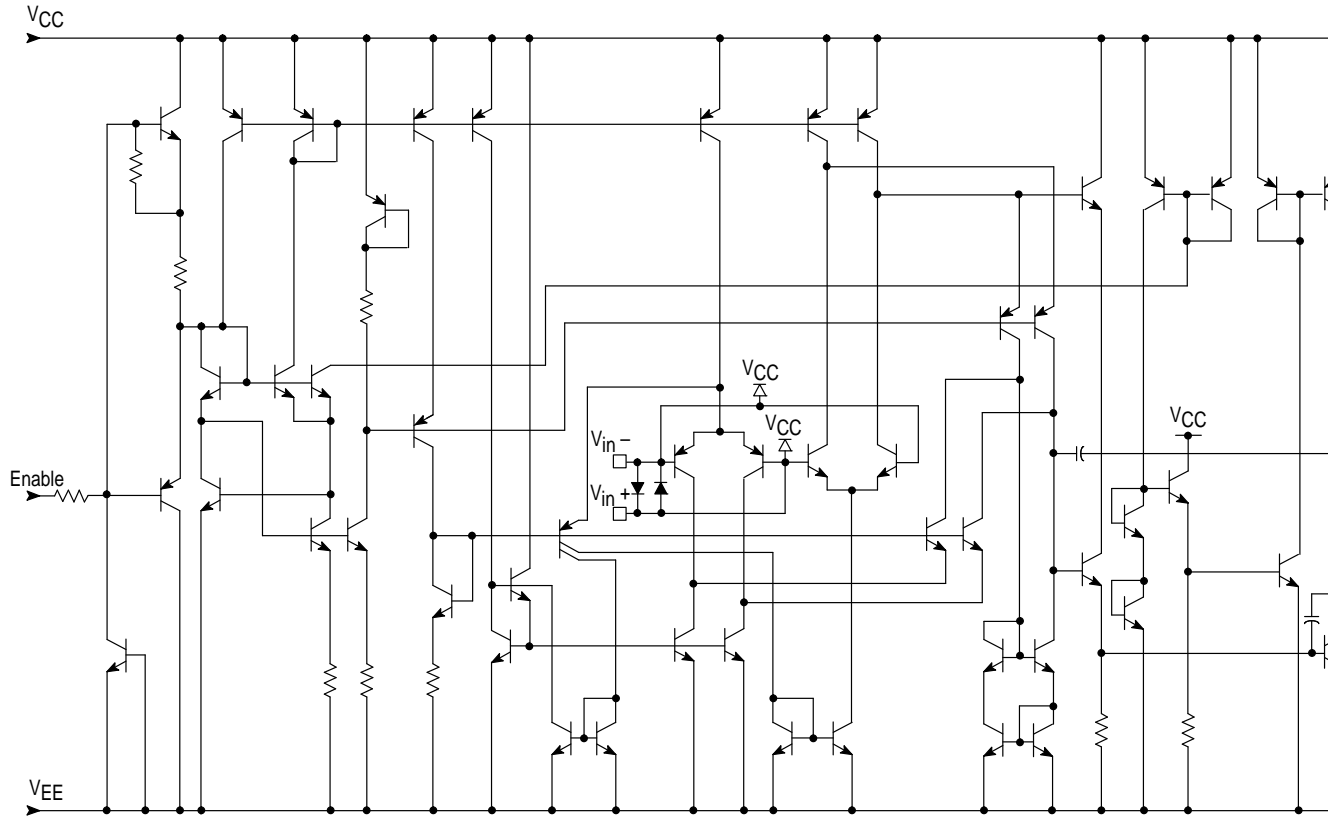

This device contains 96 active transistors (each amplifier).

Figure 2. Maximum Power Dissipation versus Temperature

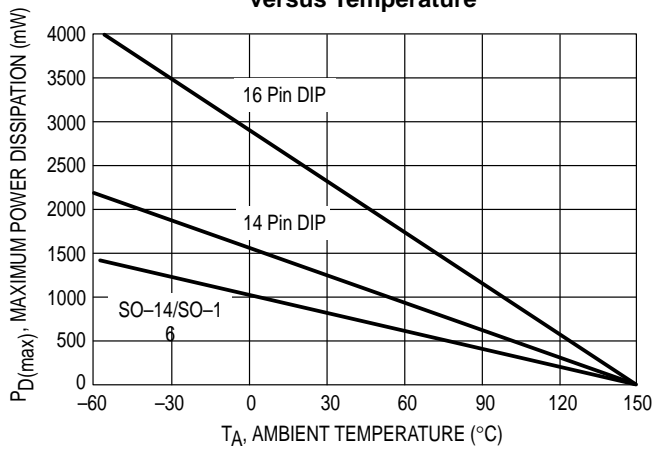

Figure 3. Input Offset Voltage Distribution

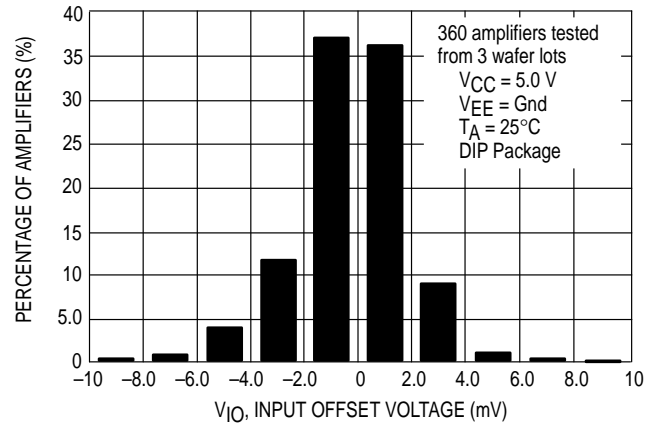

Figure 4. Input Offset Voltage Temperature Coefficient Distribution

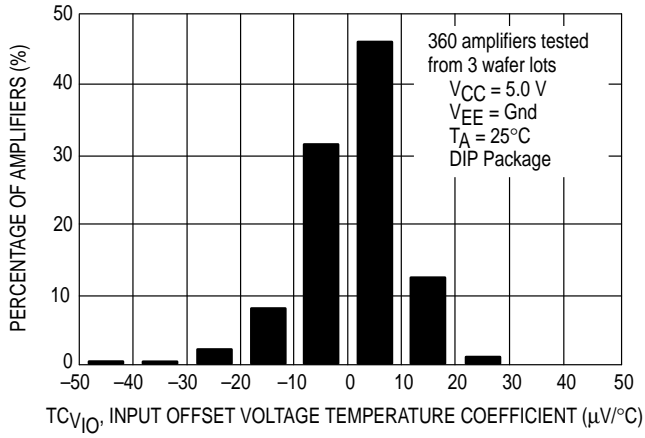

Figure 5. Input Bias Current versus Temperature

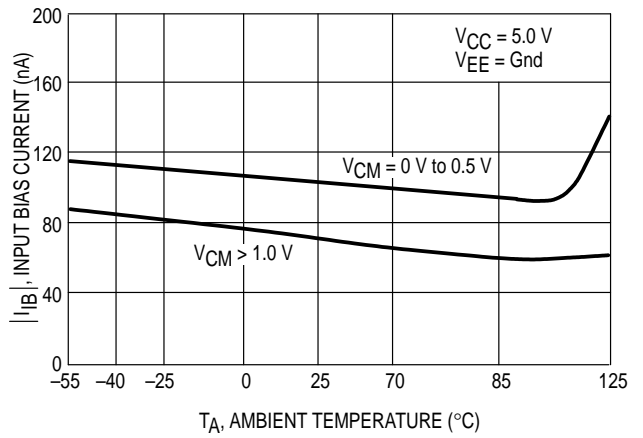

Figure 6. Input Bias Current versus Common Mode Voltage

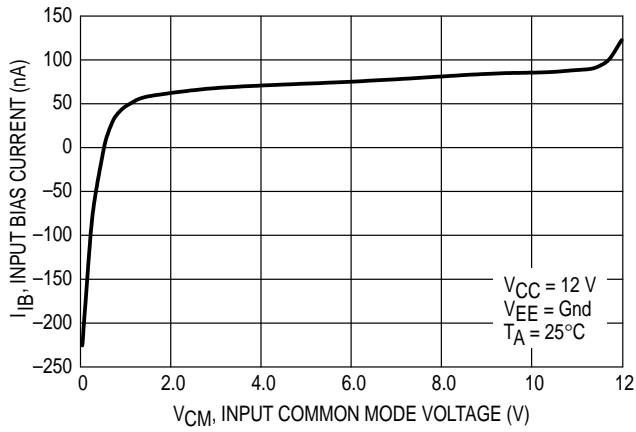

Figure 7. Open Loop Voltage Gain versus Temperature

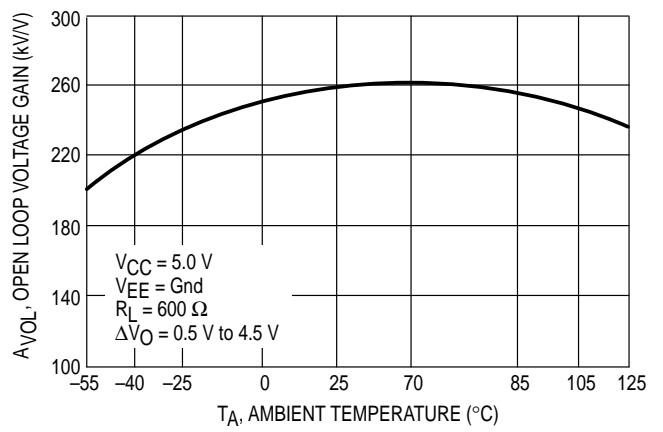

Figure 8. Output Voltage Swing versus Supply Voltage

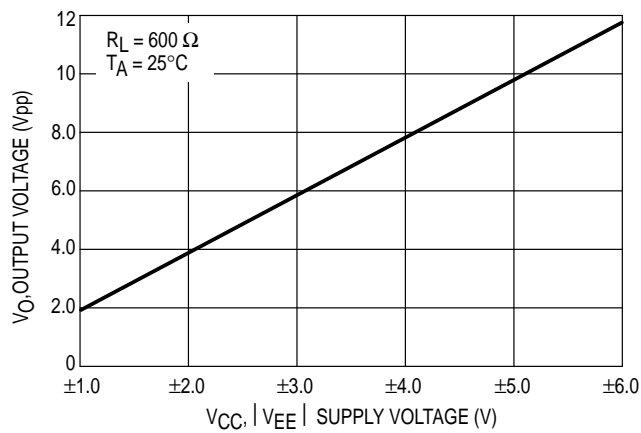

Figure 9. Output Saturation Voltage versus Load Current

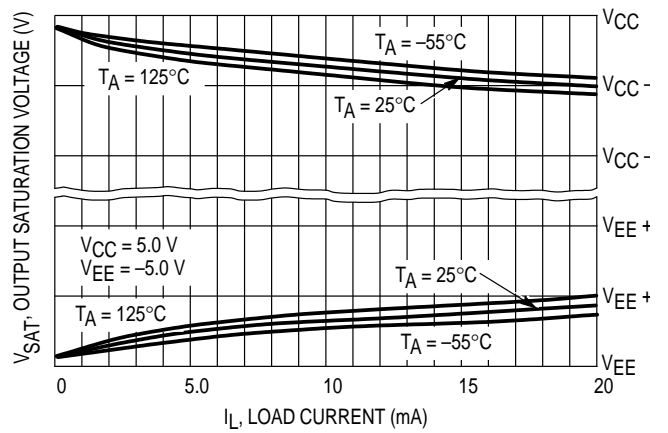

Figure 10. Output Voltage versus Frequency

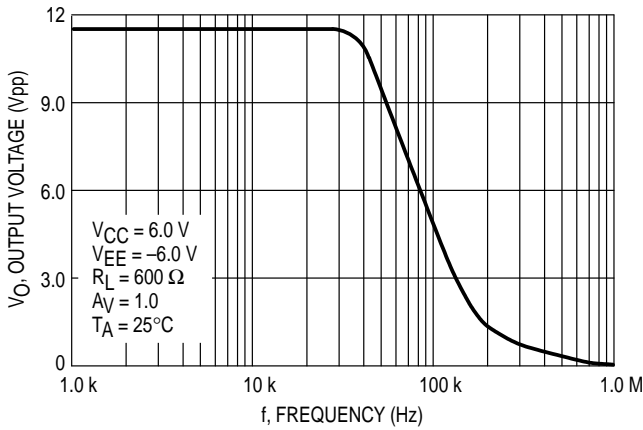

Figure 11. Common Mode Rejection versus Frequency

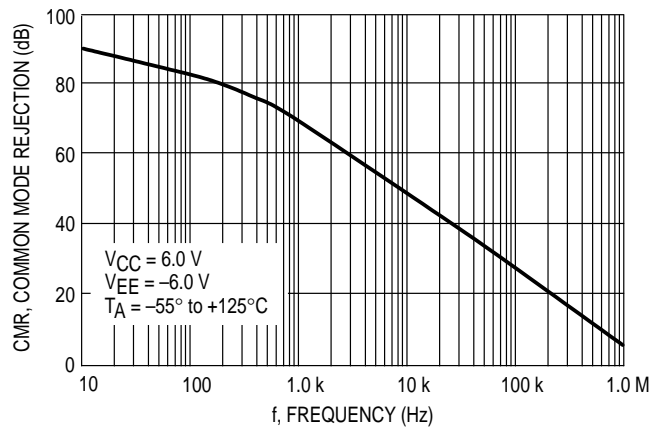

Figure 12. Power Supply Rejection versus Frequency

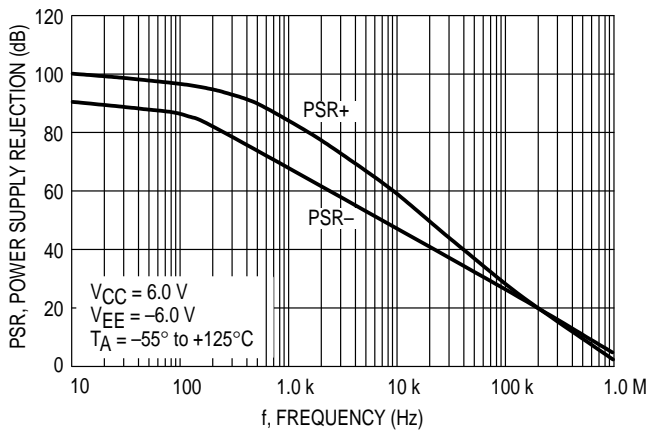

Figure 13. Output Short Circuit Current versus Output Voltage

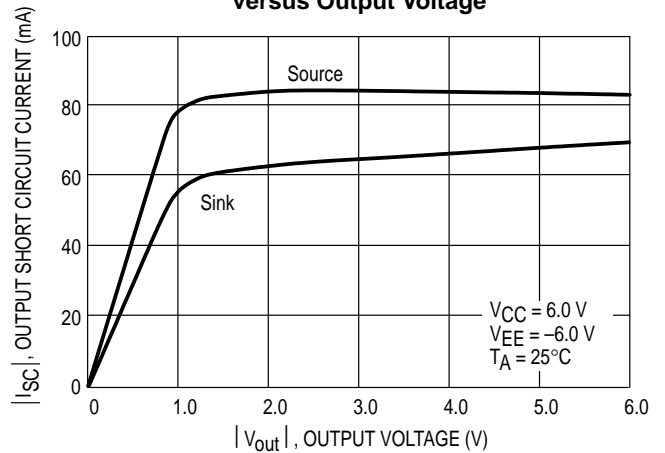

Figure 14. Output Short Circuit Current versus Temperature

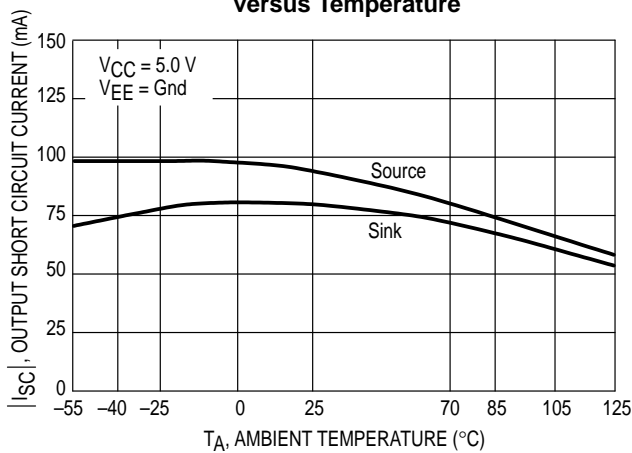

Figure 15. Supply Current per Amplifier versus Supply Voltage with No Load

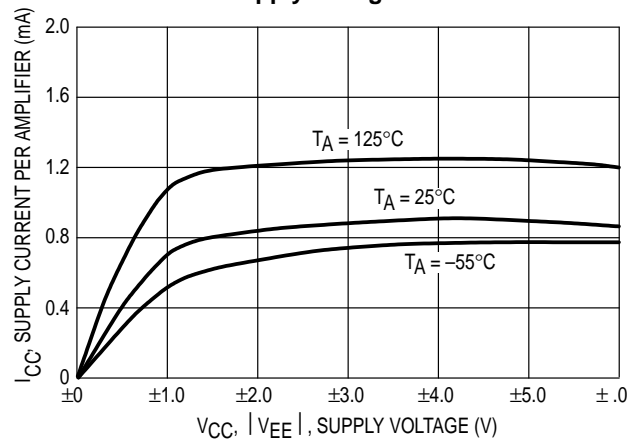

Figure 16. Slew Rate versus Temperature

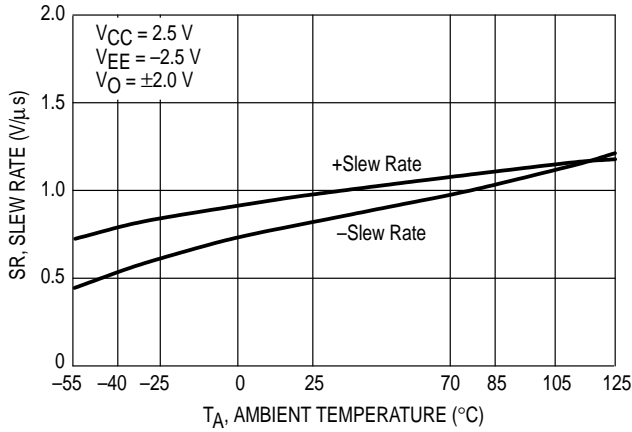

Figure 17. Gain Bandwidth Product versus Temperature

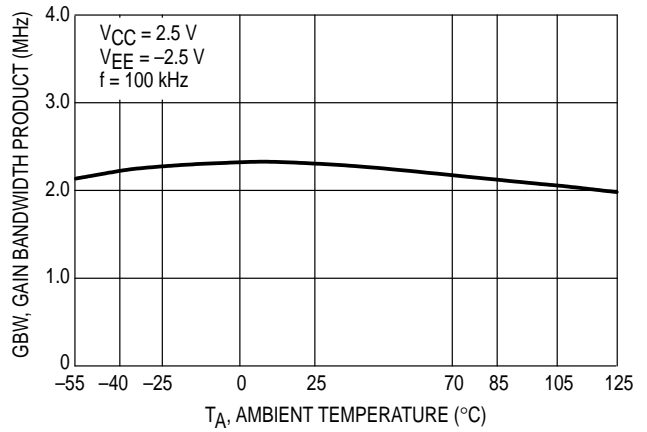

Figure 18. Voltage Gain and Phase versus Frequency

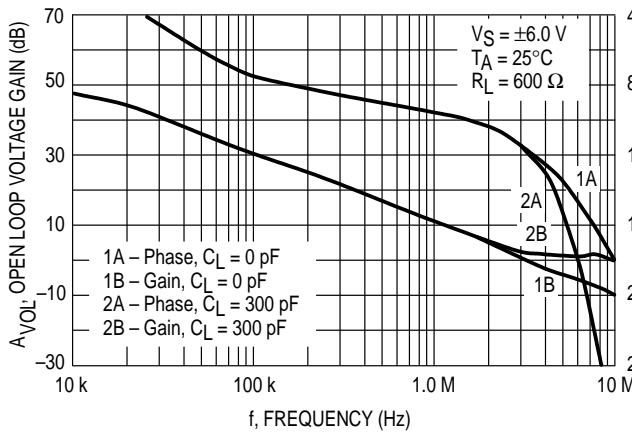

Figure 19. Voltage Gain and Phase versus Frequency

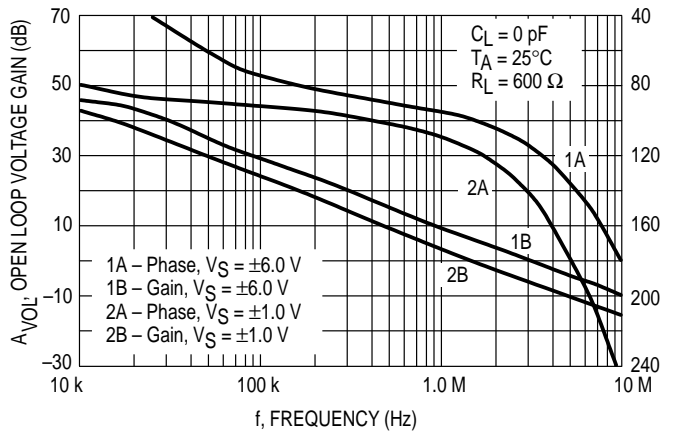

Figure 20. Gain and Phase Margin versus Temperature

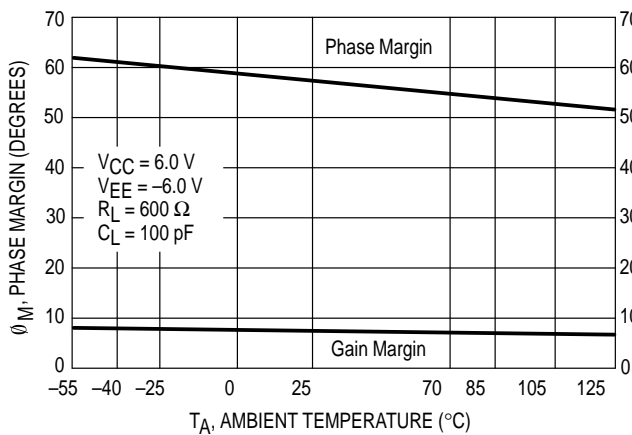

Figure 21. Gain and Phase Margin versus Differential Source Resistance

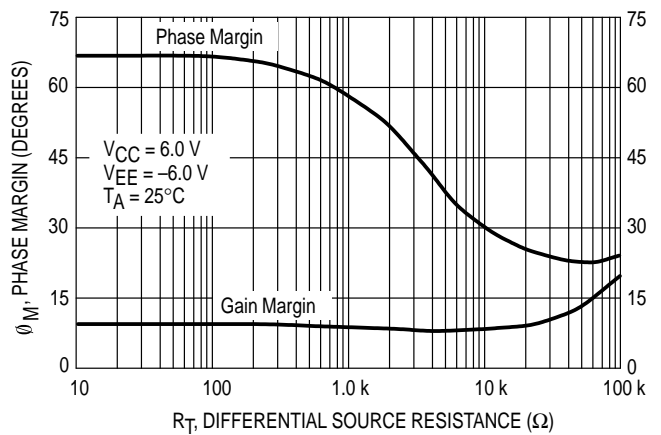

Figure 22. Gain and Phase Margin versus Capacitive Load

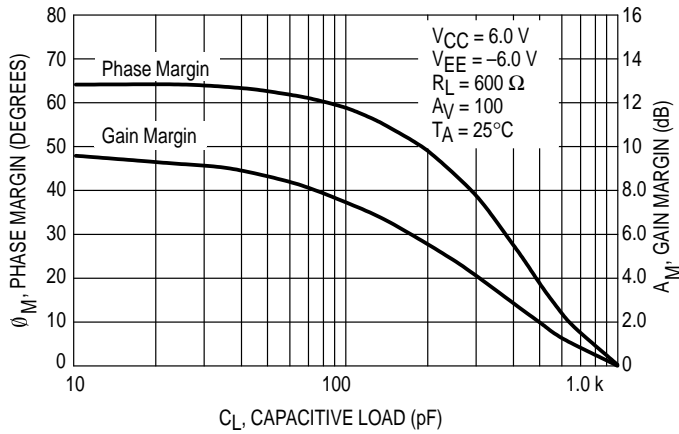

Figure 23. Output Voltage versus Load Resistance

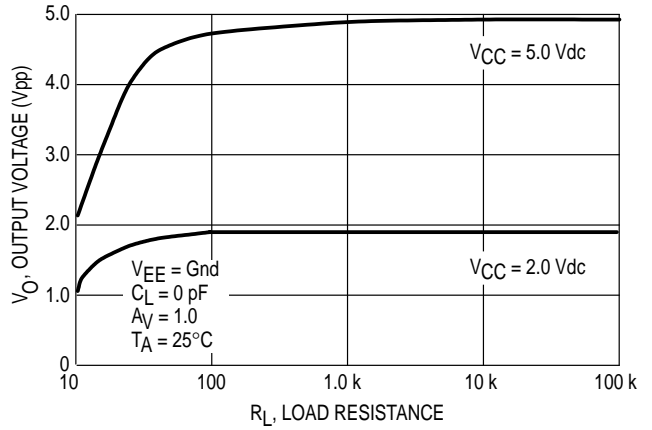

Figure 24. Channel Separation versus Frequency

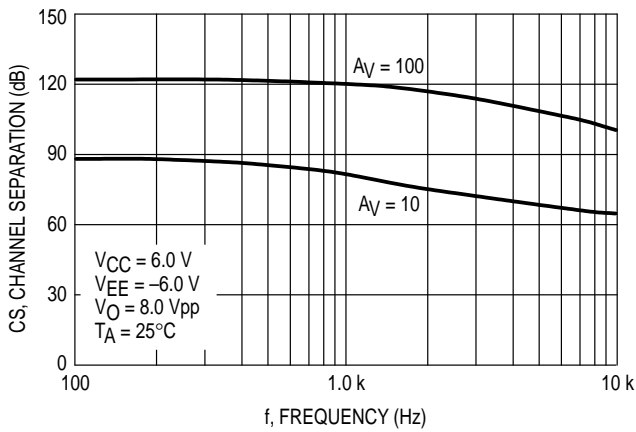

Figure 25. Total Harmonic Distortion versus Frequency

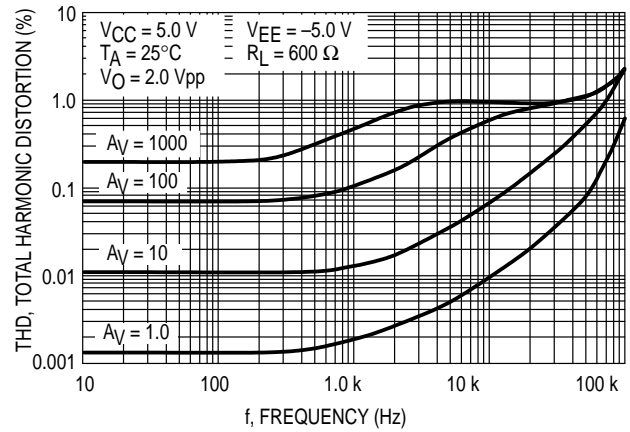
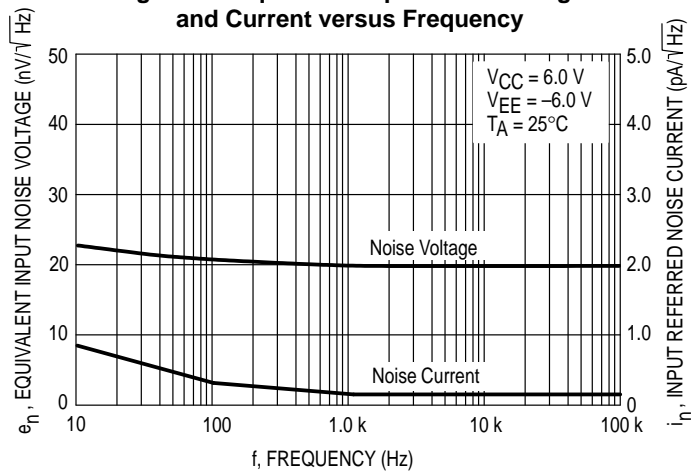

Figure 26. Equivalent Input Noise Voltage and Current versus Frequency



GENERAL INFORMATION

The MC33206/7 family of operational amplifiers are unique in their ability to swing rail-to-rail on both the input and the output with a completely bipolar design. This offers low noise, high output current capability and a wide common mode input voltage range even with low supply voltages. Operation is guaranteed over an extended temperature range and at supply voltages of 2.0 V, 3.3 V and 5.0 V and ground.

Since the common mode input voltage range extends from V_{CC} to V_{EE} , it can be operated with either single or split voltage supplies. The MC33206/7 are guaranteed not to latch or phase reverse over the entire common mode range, however, the inputs should not be allowed to exceed maximum ratings.

CIRCUIT INFORMATION

Rail-to-rail performance is achieved at the input of the amplifiers by using parallel NPN-PNP differential input stages. When the inputs are within 800 mV of the negative rail, the PNP stage is on. When the inputs are more than 800 mV greater than V_{EE} , the NPN stage is on. This switching of input pairs will cause a reversal of input bias currents (see Figure 6). Also, slight differences in offset voltage may be noted between the NPN and PNP pairs. Cross-coupling techniques have been used to keep this change to a minimum.

In addition to its rail-to-rail performance, the output stage is current boosted to provide 80 mA of output current, enabling the op amp to drive 600 Ω loads. Because of this high output current capability, care should be taken not to exceed the 150°C maximum junction temperature.

Enable Function

The MC33206/07 enable pins allow the user to externally control the device. (Refer to the Pin Diagram on the first page of this data sheet for enable pin connections.) If the enable pins are pulled low (Gnd) each amplifier (MC33206) and amplifier pair (MC33207) will be disabled. When the enable pins are at a logic high ($V_{Enable} \geq V_{EE} = 1.8 V$) the amplifiers will turn "on". Refer to the data sheet characteristics for the required levels needed to change logical state.

The time to change states (from device "on" to "off" and "off" to "on") is defined as the time delay. The Circuit in Figure 27 is used to measure t_{on} and t_{off} . Typical t_{on} and t_{off} measurements are shown in Figures 28 and 29. When the device is turned off ($V_{Enable} = Gnd$) an internal regulator is shut off disabling the amplifier.

Figure 27. Test Circuit for t_{on} and t_{off}

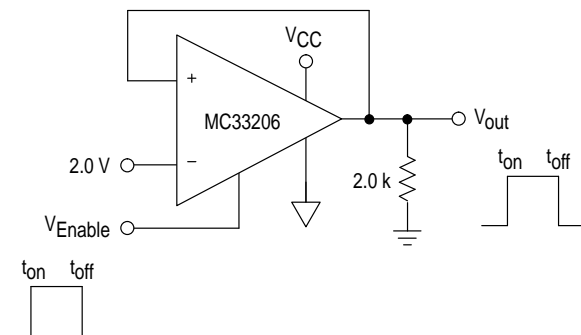

Figure 28. t_{on} Response

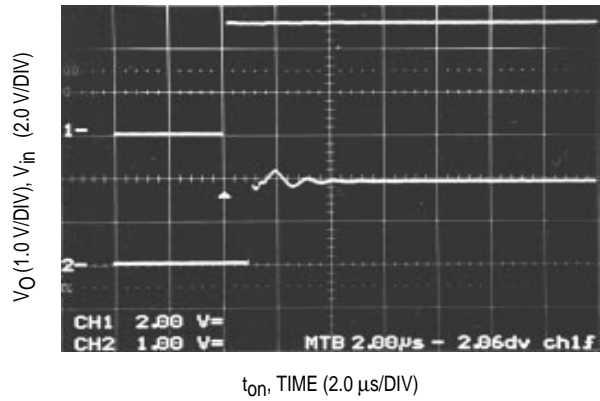
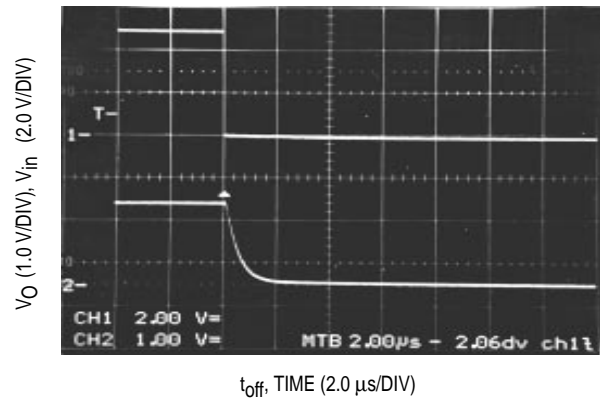

Figure 29. t_{off} Response



Low Voltage Operation

The MC33206/07 will operate at supply voltages down to 1.8 V and ground. Since this device is a rail-to-rail on both the input and output, one can be assured of continued operation in battery applications when battery voltages drop to low voltage levels. This is called End of Discharge (see Figure 30). Now, the user can select a minimum quantity of batteries best suited for the particular design depending on the type of battery chosen. This will minimize part count in many designs.

Figure 30. Typical Battery Characteristics

Type	Operating Voltage	End of Discharge
Alkaline	1.5 V	0.9 V
NiCd	1.2 V	1.0 V
NiMh	1.2 V	1.0 V
Silver Oxide	1.6 V	1.3 V
Lithium Ion	3.6 V	2.5 V

Compensating for Output Capacitance

The combination of device output impedance and increasing capacitive loading will cause phase delay (reducing the phase margin) in any amplifier (Figure 22). If the loading is excessive, the resulting response can be circuit oscillation. In other words, an amplifier can become unstable when the phase becomes greater than 180 degrees before the open loop gain drops to unity gain. Figures 18 and 19 show this situation as frequency increases for a given load. The MC33206/7 can typically drive up to 300 pF loads at unity gain without oscillating.

Figure 31. Capacitive Loads Compensation

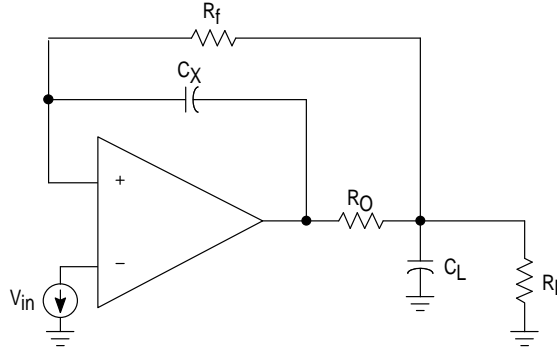

There are several ways to compensate for this phenomena. Adding series resistance to the output is one way, but not an ideal solution. A dc voltage error will occur at the output. A better design solution to compensate for higher capacitive loads would be to use the circuit in Figure 31. This design helps to counteract the loss of phase margin by taking the high frequency output signal and feeding it back into the amplifier inverting input. This technique helps to overcome oscillation due to a highly capacitive load. Keep in mind that compensation will have the affect of lowering the Gain Bandwidth Product (GPW). The values of C_X and R_O , are determined experimentally. Typical C_X and C_L will be the same value.

SPICE Model

If a SPICE Macromodel is desired for the MC33206/07, the user can define the characteristics from the following information. Obtain the SPICE Macromodel for the MC33204 Rail-to-Rail Operational Amplifier (device is the same as the MC33207). For the Enable feature of the MC33207, simulate it as a bipolar switch. The Macromodel does not include an input capacitance between the inverting and noninverting inputs. This capacitor is called C_{in} . Add 3.0 to 5.0 pF if stability analysis is required.

Figure 32. Noninverting Amplifier Slew Rate

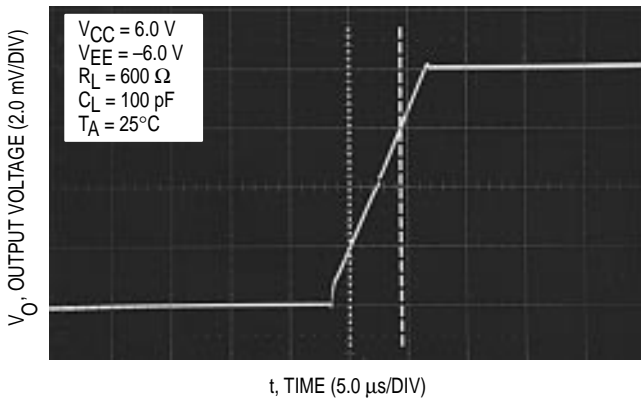

Figure 33. Small Signal Transient Response

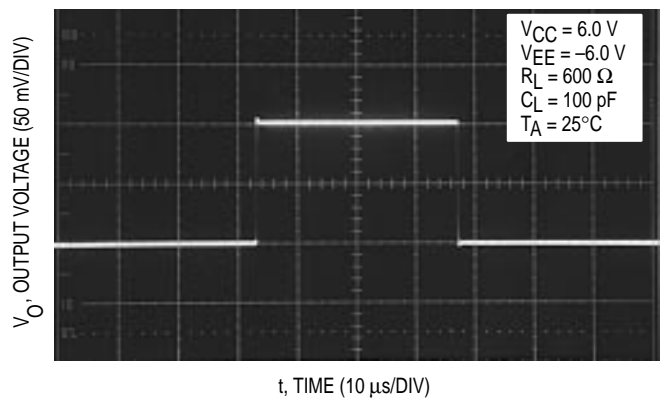
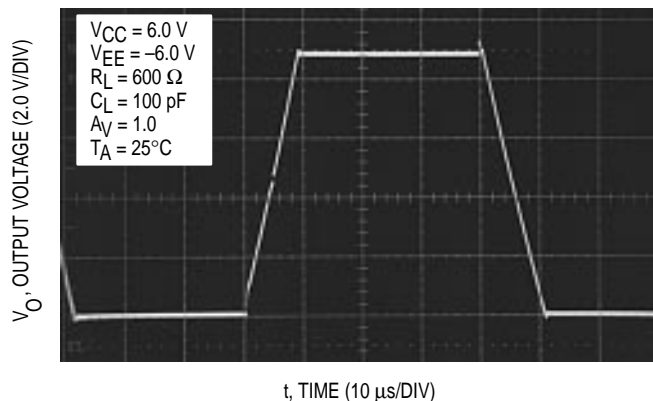
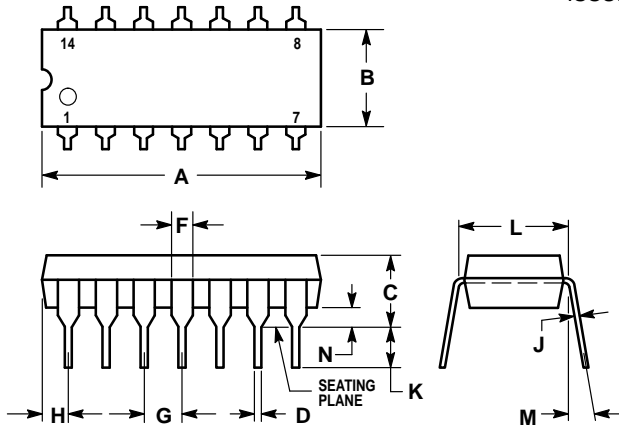

Figure 34. Large Signal Transient Response



OUTLINE DIMENSIONS

P SUFFIX
PLASTIC PACKAGE
CASE 646-06
ISSUE L



- NOTES:
- LEADS WITHIN 0.13 (0.005) RADIUS OF TRUE POSITION AT SEATING PLANE AT MAXIMUM MATERIAL CONDITION.
 - DIMENSION L TO CENTER OF LEADS WHEN FORMED PARALLEL.
 - DIMENSION B DOES NOT INCLUDE MOLD FLASH.
 - ROUNDED CORNERS OPTIONAL.

DIM	INCHES		MILLIMETERS	
	MIN	MAX	MIN	MAX
A	0.715	0.770	18.16	19.56
B	0.240	0.260	6.10	6.60
C	0.145	0.185	3.69	4.69
D	0.015	0.021	0.38	0.53
F	0.040	0.070	1.02	1.78
G	0.100 BSC		2.54 BSC	
H	0.052	0.095	1.32	2.41
J	0.008	0.015	0.20	0.38
K	0.115	0.135	2.92	3.43
L	0.300 BSC		7.62 BSC	
M	0°	10°	0°	10°
N	0.015	0.039	0.39	1.01

D SUFFIX
PLASTIC PACKAGE
CASE 751A-03
(SO-14)
ISSUE F

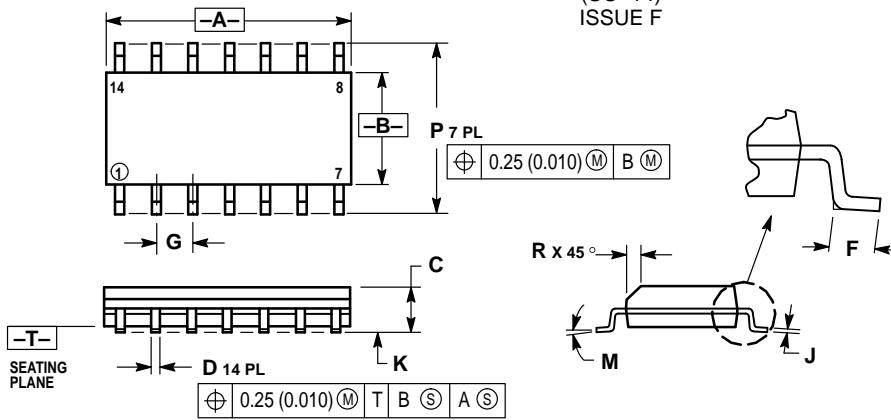

- NOTES:
- DIMENSIONING AND TOLERANCING PER ANSI Y14.5M, 1982.
 - CONTROLLING DIMENSION: MILLIMETER.
 - DIMENSIONS A AND B DO NOT INCLUDE MOLD PROTRUSION.
 - MAXIMUM MOLD PROTRUSION 0.15 (0.006) PER SIDE.
 - DIMENSION D DOES NOT INCLUDE DAMBAR PROTRUSION. ALLOWABLE DAMBAR PROTRUSION SHALL BE 0.127 (0.005) TOTAL IN EXCESS OF THE D DIMENSION AT MAXIMUM MATERIAL CONDITION.

DIM	MILLIMETERS		INCHES	
	MIN	MAX	MIN	MAX
A	8.55	8.75	0.337	0.344
B	3.80	4.00	0.150	0.157
C	1.35	1.75	0.054	0.068
D	0.35	0.49	0.014	0.019
F	0.40	1.25	0.016	0.049
G	1.27 BSC		0.050 BSC	
J	0.19	0.25	0.008	0.009
K	0.10	0.25	0.004	0.009
M	0°	7°	0°	7°
P	5.80	6.20	0.228	0.244
R	0.25	0.50	0.010	0.019

P SUFFIX
PLASTIC PACKAGE
CASE 648-08
ISSUE R

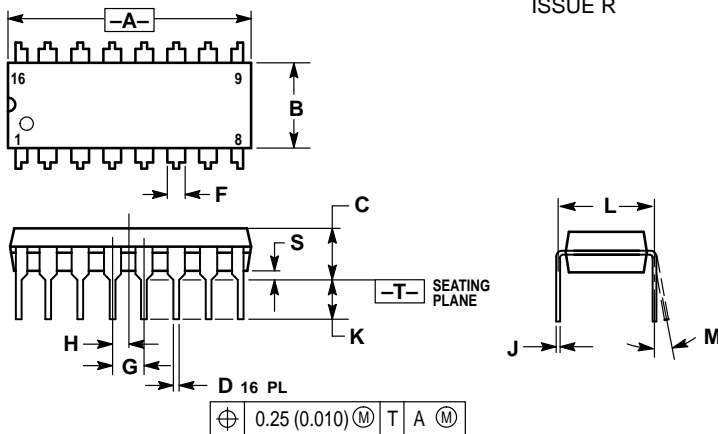

- NOTES:
- DIMENSIONING AND TOLERANCING PER ANSI Y14.5M, 1982.
 - CONTROLLING DIMENSION: INCH.
 - DIMENSION L TO CENTER OF LEADS WHEN FORMED PARALLEL.
 - DIMENSION B DOES NOT INCLUDE MOLD FLASH.
 - ROUNDED CORNERS OPTIONAL.

DIM	INCHES		MILLIMETERS	
	MIN	MAX	MIN	MAX
A	0.740	0.770	18.80	19.55
B	0.250	0.270	6.35	6.85
C	0.145	0.175	3.69	4.44
D	0.015	0.021	0.39	0.53
F	0.040	0.70	1.02	1.77
G	0.100 BSC		2.54 BSC	
H	0.050 BSC		1.27 BSC	
J	0.008	0.015	0.21	0.38
K	0.110	0.130	2.80	3.30
L	0.295	0.305	7.50	7.74
M	0°	10°	0°	10°
S	0.020	0.040	0.51	1.01

MC33206 MC33207

OUTLINE DIMENSIONS

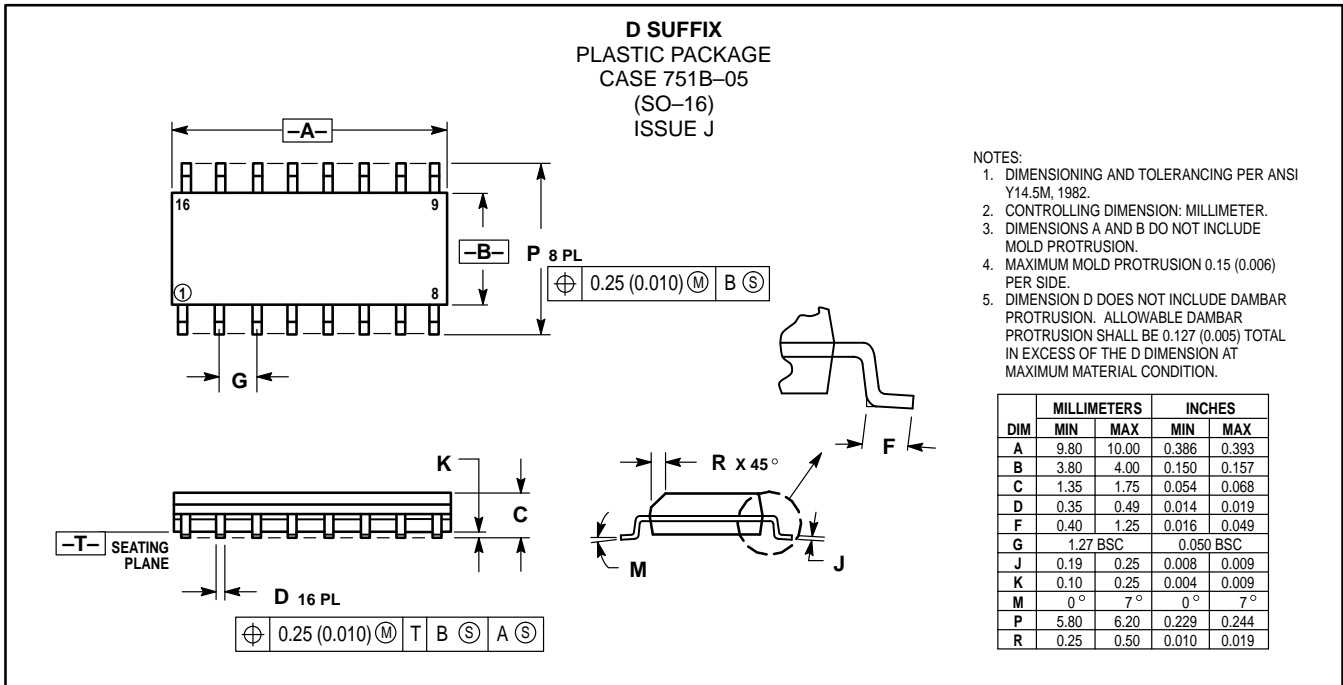

Motorola reserves the right to make changes without further notice to any products herein. Motorola makes no warranty, representation or guarantee regarding the suitability of its products for any particular purpose, nor does Motorola assume any liability arising out of the application or use of any product or circuit, and specifically disclaims any and all liability, including without limitation consequential or incidental damages. "Typical" parameters which may be provided in Motorola data sheets and/or specifications can and do vary in different applications and actual performance may vary over time. All operating parameters, including "Typicals" must be validated for each customer application by customer's technical experts. Motorola does not convey any license under its patent rights nor the rights of others. Motorola products are not designed, intended, or authorized for use as components in systems intended for surgical implant into the body, or other applications intended to support or sustain life, or for any other application in which the failure of the Motorola product could create a situation where personal injury or death may occur. Should Buyer purchase or use Motorola products for any such unintended or unauthorized application, Buyer shall indemnify and hold Motorola and its officers, employees, subsidiaries, affiliates, and distributors harmless against all claims, costs, damages, and expenses, and reasonable attorney fees arising out of, directly or indirectly, any claim of personal injury or death associated with such unintended or unauthorized use, even if such claim alleges that Motorola was negligent regarding the design or manufacture of the part. Motorola and are registered trademarks of Motorola, Inc. Motorola, Inc. is an Equal Opportunity/Affirmative Action Employer.

How to reach us:

USA/EUROPE/Locations Not Listed: Motorola Literature Distribution; P.O. Box 20912; Phoenix, Arizona 85036. 1-800-441-2447 or 602-303-5454

JAPAN: Nippon Motorola Ltd.; Tatsumi-SPD-JLDC, 6F Seibu-Butsuryu-Center, 3-14-2 Tatsumi Koto-Ku, Tokyo 135, Japan. 03-81-3521-8315

MFAX: RMFAX0@email.sps.mot.com – TOUCHTONE 602-244-6609
INTERNET: http://Design-NET.com

ASIA/PACIFIC: Motorola Semiconductors H.K. Ltd.; 8B Tai Ping Industrial Park, 51 Ting Kok Road, Tai Po, N.T., Hong Kong. 852-26629298

