

Product Preview

256K x 16 Bit 3.3 V Asynchronous Fast Static RAM

The MCM6343 is a 4,194,304-bit static random access memory organized as 262,144 words of 16 bits. Static design eliminates the need for external clocks or timing strobes.

The MCM6343 is equipped with chip enable (\bar{E}), write enable (\bar{W}), and output enable (\bar{G}) pins, allowing for greater system flexibility and eliminating bus contention problems. Separate byte enable controls (LB and UB) allow individual bytes to be written and read. LB controls the lower bits DQ0 to DQ7, while UB controls the upper bits DQ8 to DQ15.

The MCM6343 is available in a 400 mil, 44-lead small-outline SOJ package and a 44-lead TSOP Type II package.

- Single 3.3 V \pm 0.3 V Power Supply
- Fast Access Time: 12/15 ns
- Equal Address and Chip Enable Access Time
- All Inputs and Outputs are TTL Compatible
- Data Byte Control
- Fully Static Operation
- Power Operation: 250/240/230 mA Maximum, Active AC
- Commercial and Standard Industrial Temperature Option: - 40 to + 85°C

BLOCK DIAGRAM

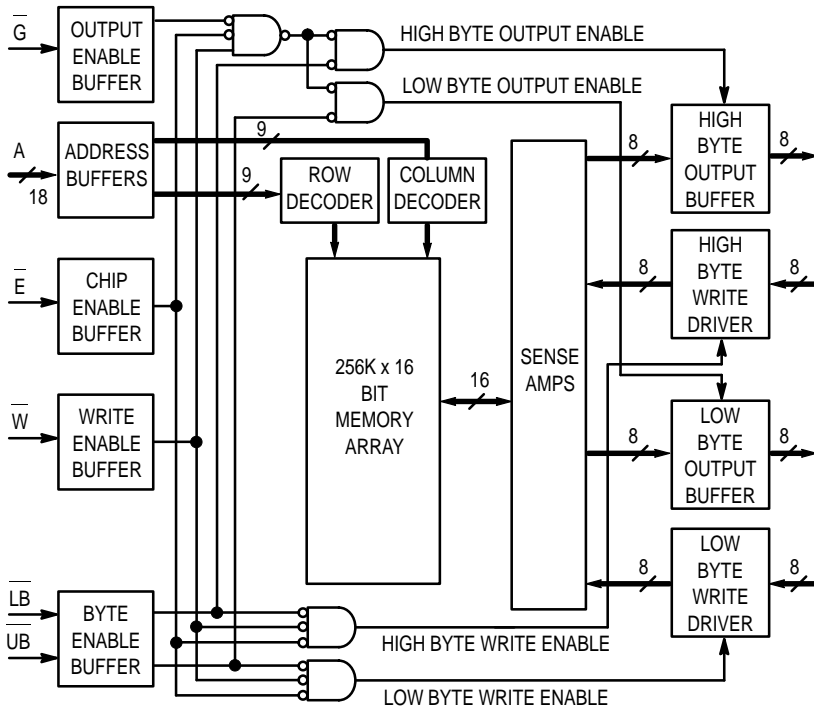

MCM6343

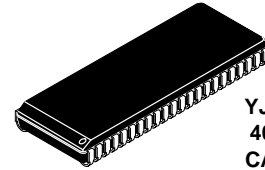

YJ PACKAGE
400 MIL SOJ
CASE 919-01



TS PACKAGE
TSOP TYPE II
CASE 924A-02

PIN ASSIGNMENT

A	1	44	A
A	2	43	A
A	3	42	A
A	4	41	G
A	5	40	UB
E	6	39	LB
DQ0	7	38	DQ15
DQ1	8	37	DQ14
DQ2	9	36	DQ13
DQ3	10	35	DQ12
VDD	11	34	VSS
VSS	12	33	VDD
DQ4	13	32	DQ11
DQ5	14	31	DQ10
DQ6	15	30	DQ9
DQ7	16	29	DQ8
W	17	28	NC
A	18	27	A
A	19	26	A
A	20	25	A
A	21	24	A
A	22	23	A

PIN NAMES

A0 - A17	Address Input
E	Chip Enable
W	Write Enable
G	Output Enable
UB	Upper Byte
LB	Lower Byte
DQ0 - DQ15	Data Input/Output
VDD	+ 3.3 V Power Supply
VSS	Ground
NC	No Connection

This document contains information on a product under development. Motorola reserves the right to change or discontinue this product without notice.

REV 2
2/10/98

TRUTH TABLE (X = Don't Care)

E	G	W	LB	UB	Mode	V _{DD} Current	DQ0 – DQ7	DQ8 – DQ15
H	X	X	X	X	Not Selected	I _{SB1} , I _{SB2}	High-Z	High-Z
L	H	H	X	X	Output Disabled	I _{DDA}	High-Z	High-Z
L	X	X	H	H	Output Disabled	I _{DDA}	High-Z	High-Z
L	L	H	L	H	Low Byte Read	I _{DDA}	D _{out}	High-Z
L	L	H	H	L	High Byte Read	I _{DDA}	High-Z	D _{out}
L	L	H	L	L	Word Read	I _{DDA}	D _{out}	D _{out}
L	X	L	L	H	Low Byte Write	I _{DDA}	D _{in}	High-Z
L	X	L	H	L	High Byte Write	I _{DDA}	High-Z	D _{in}
L	X	L	L	L	Word Write	I _{DDA}	D _{in}	D _{in}

ABSOLUTE MAXIMUM RATINGS (See Notes)

Rating	Symbol	Value	Unit
Supply Voltage	V _{DD}	- 0.5 to + 4.6	V
Voltage on Any Pin	V _{in}	- 0.5 to V _{DD} + 0.5	V
Output Current per Pin	I _{out}	± 20	mA
Package Power Dissipation	P _D	TBD	W
Temperature Under Bias	T _{bias}	- 10 to + 85 - 45 to + 90	°C
Operating Temperature	T _A	0 to + 70 - 45 to + 85	°C
Storage Temperature	T _{stg}	- 55 to + 150	°C

This device contains circuitry to protect the inputs against damage due to high static voltages or electric fields; however, it is advised that normal precautions be taken to avoid application of any voltage higher than maximum rated voltages to these high-impedance circuits.

This CMOS memory circuit has been designed to meet the dc and ac specifications shown in the tables, after thermal equilibrium has been established. The circuit is in a test socket or mounted on a printed circuit board and transverse air flow of at least 500 linear feet per minute is maintained.

NOTES:

1. Permanent device damage may occur if ABSOLUTE MAXIMUM RATINGS are exceeded. Functional operation should be restricted to RECOMMENDED OPERATING CONDITIONS. Exposure to higher than recommended voltages for extended periods of time could affect device reliability.
2. All voltages are referenced to V_{SS}.
3. Power dissipation capability will be dependent upon package characteristics and use environment.

DC OPERATING CONDITIONS AND CHARACTERISTICS

($V_{DD} = 3.3 \text{ V} \pm 0.3 \text{ V}$, $T_A = 0 \text{ to } 70^\circ\text{C}$, Unless Otherwise Noted)

($T_A = -40 \text{ to } +85^\circ\text{C}$ for Industrial Temperature Offering)

RECOMMENDED OPERATING CONDITIONS

Parameter	Symbol	Min	Typ	Max	Unit
Power Supply Voltage	V_{DD}	3.0	3.3	3.6	V
Input High Voltage	V_{IH}	2.2	—	$V_{DD} + 0.3^{**}$	V
Input Low Voltage	V_{IL}	-0.5^*	—	0.8	V

* $V_{IL}(\text{min}) = -0.5 \text{ V dc}$; $V_{IL}(\text{min}) = -2.0 \text{ V ac}$ (pulse width $\leq 20 \text{ ns}$) for $I \leq 20.0 \text{ mA}$.

** $V_{IH}(\text{max}) = V_{DD} + 0.3 \text{ V dc}$; $V_{IH}(\text{max}) = V_{DD} + 2.0 \text{ V ac}$ (pulse width $\leq 20 \text{ ns}$) for $I \leq 20.0 \text{ mA}$.

DC CHARACTERISTICS

Parameter	Symbol	Min	Max	Unit
Input Leakage Current (All Inputs, $V_{in} = 0 \text{ to } V_{DD}$)	$I_{lkg(I)}$	—	± 1.0	μA
Output Leakage Current ($E = V_{IH}$, $V_{out} = 0 \text{ to } V_{DD}$)	$I_{lkg(O)}$	—	± 1.0	μA
Output Low Voltage ($I_{OL} = +4.0 \text{ mA}$) ($I_{OL} = +100 \mu\text{A}$)	V_{OL}	—	0.4 $V_{SS} + 0.2$	V
Output High Voltage ($I_{OH} = -4.0 \text{ mA}$) ($I_{OH} = -100 \mu\text{A}$)	V_{OH}	2.4 $V_{DD} - 0.2$	—	V

POWER SUPPLY CURRENTS

Parameter	Symbol	0 to 70°C	-40 to +85°C	Unit
AC Active Supply Current ($I_{out} = 0 \text{ mA}$, $V_{CC} = \text{max}$) MCM6343-12: $t_{AVAV} = 12 \text{ ns}$ MCM6343-15: $t_{AVAV} = 15 \text{ ns}$	I_{CC}	240 230	240	mA
AC Standby Current ($V_{CC} = \text{max}$, $E = V_{IH}$, No other restrictions on other inputs) MCM6343-12: $t_{AVAV} = 12 \text{ ns}$ MCM6343-15: $t_{AVAV} = 15 \text{ ns}$	I_{SB1}	50 45	55 50	mA
CMOS Standby Current ($E \geq V_{CC} - 0.2 \text{ V}$, $V_{in} \leq V_{SS} + 0.2 \text{ V}$ or $\geq V_{CC} - 0.2 \text{ V}$) ($V_{CC} = \text{max}$, $f = 0 \text{ MHz}$)	I_{SB2}	5	5	mA

CAPACITANCE ($f = 1.0 \text{ MHz}$, $dV = 3.0 \text{ V}$, $T_A = 25^\circ\text{C}$, Periodically Sampled Rather Than 100% Tested)

Parameter	Symbol	Typ	Max	Unit
Address Input Capacitance	C_{in}	—	6	pF
Control Input Capacitance	C_{in}	—	6	pF
Input/Output Capacitance	$C_{I/O}$	—	8	pF

AC OPERATING CONDITIONS AND CHARACTERISTICS

($V_{CC} = 3.3\text{ V} \pm 0.3\text{ V}$, $T_A = 0\text{ to } +70^\circ\text{C}$, Unless Otherwise Noted)

($T_A = -40\text{ to } +85^\circ\text{C}$ for Industrial Temperature Offering)

Logic Input Timing Measurement Reference Level 1.50 V
 Logic Input Pulse Levels 0 to 3.0 V
 Input Rise/Fall Time 2 ns

Output Timing Reference Level 1.50 V
 Output Load See Figure 1

READ CYCLE TIMING (See Notes 1, 2, and 3)

Parameter	Symbol	MCM6343-12		MCM6343-15		Unit	Notes
		Min	Max	Min	Max		
Read Cycle Time	t_{AVAV}	12	—	15	—	ns	4
Address Access Time	t_{AVQV}	—	12	—	15	ns	
Enable Access Time	t_{ELQV}	—	12	—	15	ns	5
Output Enable Access Time	t_{GLQV}	—	6	—	7	ns	
Output Hold from Address Change	t_{AXQX}	3	—	3	—	ns	
Enable Low to Output Active	t_{ELQX}	3	—	3	—	ns	6, 7, 8
Output Enable Low to Output Active	t_{GLQX}	0	—	0	—	ns	6, 7, 8
Enable High to Output High-Z	t_{EHQZ}	0	6	0	7	ns	6, 7, 8
Output Enable High to Output High-Z	t_{GHQZ}	0	6	0	7	ns	6, 7, 8
Byte Enable Access Time	t_{BLQV}	—	6	—	7	ns	
Byte Enable Low to Output Active	t_{BLQX}	0	—	0	—	ns	6, 7, 8
Byte High to Output High-Z	t_{BHQZ}	0	6	0	7	ns	6, 7, 8

NOTES:

1. W is high for read cycle.
2. Product sensitivities to noise require proper grounding and decoupling of power supplies as well as minimization or elimination of bus contention conditions during read and write cycles.
3. Device is continuously selected ($E \leq V_{IL}$, $G \leq V_{IL}$).
4. All read cycle timings are referenced from the last valid address to the first transitioning address.
5. Addresses valid prior to or coincident with E going low.
6. At any given voltage and temperature, $t_{EHQZ}\text{ max} < t_{ELQX}\text{ min}$, and $t_{GHQZ}\text{ max} < t_{GLQX}\text{ min}$, both for a given device and from device to device.
7. This parameter is sampled and not 100% tested.
8. Transition is measured $\pm 200\text{ mV}$ from steady-state voltage.

TIMING LIMITS

The table of timing values shows either a minimum or a maximum limit for each parameter. Input requirements are specified from the external system point of view. Thus, address setup time is shown as a minimum since the system must supply at least that much time. On the other hand, responses from the memory are specified from the device point of view. Thus, the access time is shown as a maximum since the device never provides data later than that time.

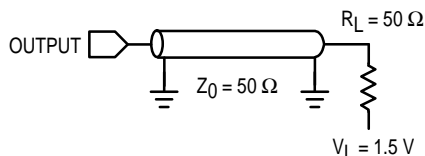
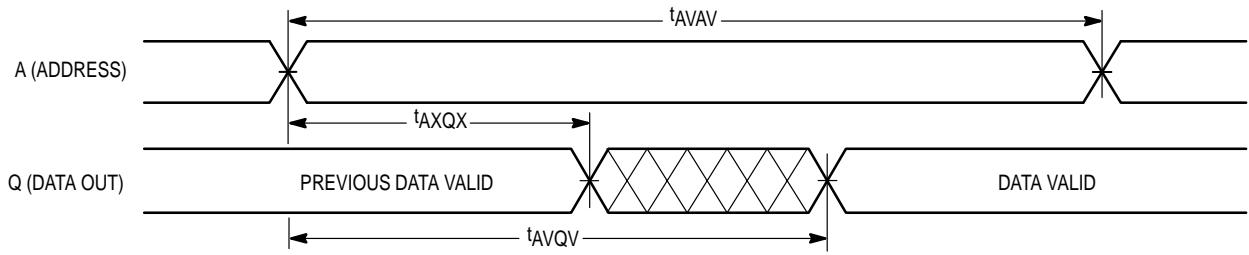
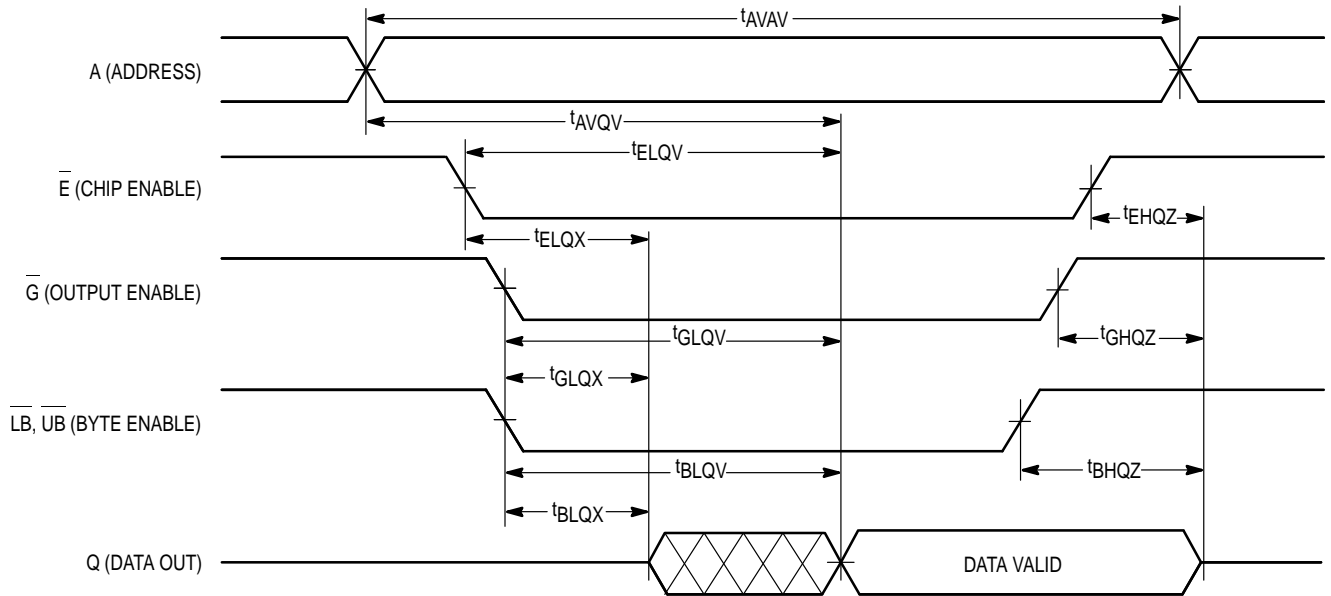

Figure 1. AC Test Load

READ CYCLE 1 (See Note 8)



READ CYCLE 2 (See Note 4)



WRITE CYCLE 1 (\bar{W} Controlled; See Notes 1, 2, and 3)

Parameter	Symbol	MCM6343-12		MCM6343-15		Unit	Notes
		Min	Max	Min	Max		
Write Cycle Time	t_{AVAV}	12	—	15	—	ns	4
Address Setup Time	t_{AVWL}	0	—	0	—	ns	
Address Valid to End of Write	t_{AVWH}	10	—	12	—	ns	
Address Valid to End of Write (G High)	t_{AVWH}	9	—	10	—	ns	
Write Pulse Width	t_{WLWH} t_{WLEH}	10	—	12	—	ns	
Write Pulse Width (G High)	t_{WLWH} t_{WLEH}	9	—	10	—	ns	
Data Valid to End of Write	t_{DVWH}	6	—	7	—	ns	
Data Hold Time	t_{WHDX}	0	—	0	—	ns	
Write Low to Data High-Z	t_{WLQZ}	0	6	0	7	ns	5, 6, 7
Write High to Output Active	t_{WHQX}	3	—	3	—	ns	5, 6, 7
Write Recovery Time	t_{WHAX}	0	—	0	—	ns	

NOTES:

1. A write occurs during the overlap of \bar{E} low and \bar{W} low.
2. Product sensitivities to noise require proper grounding and decoupling of power supplies as well as minimization or elimination of bus contention conditions during read and write cycles.
3. If \bar{G} goes low coincident with or after \bar{W} goes low, the output will remain in a high-impedance state.
4. All write cycle timings are referenced from the last valid address to the first transitioning address.
5. This parameter is sampled and not 100% tested.
6. Transition is measured ± 200 mV from steady-state voltage.
7. At any given voltage and temperature, $t_{WLQZ} \text{ max} < t_{WHQX} \text{ min}$ both for a given device and from device to device.

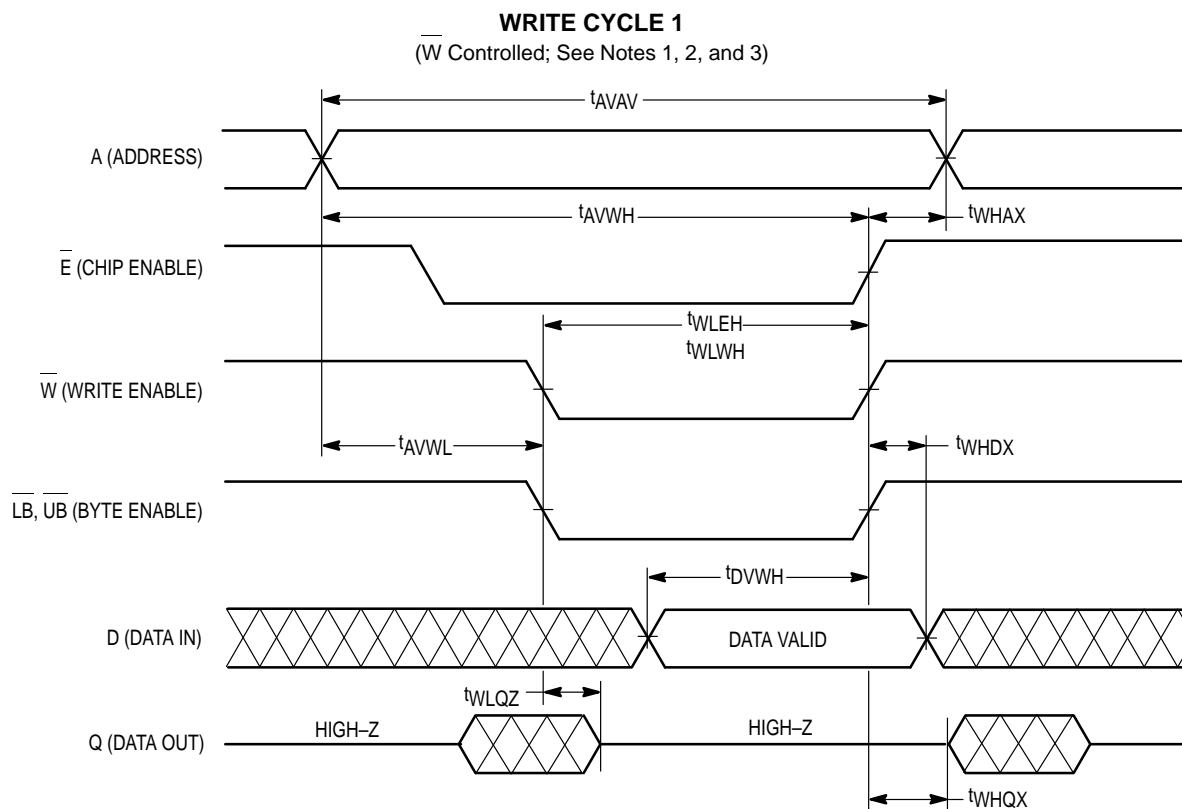

WRITE CYCLE 2 (\bar{E} Controlled; See Notes 1, 2, and 3)

Parameter	Symbol	MCM6343-12		MCM6343-15		Unit	Notes
		Min	Max	Min	Max		
Write Cycle Time	t_{AVAV}	12	—	15	—	ns	4
Address Setup Time	t_{AVEL}	0	—	0	—	ns	
Address Valid to End of Write	t_{AVEH}	10	—	12	—	ns	
Address Valid to End of Write (G High)	t_{AVEH}	9	—	10	—	ns	
Enable to End of Write	t_{ELEH} , t_{ELWH}	10	—	12	—	ns	5, 6
Enable to End of Write (G High)	t_{ELEH} , t_{ELWH}	9	—	10	—	ns	5, 6
Data Valid to End of Write	t_{DVEH}	6	—	7	—	ns	
Data Hold Time	t_{EHDX}	0	—	0	—	ns	
Write Recovery Time	t_{EHAX}	0	—	0	—	ns	

NOTES:

1. A write occurs during the overlap of \bar{E} low and \bar{W} low.
2. Product sensitivities to noise require proper grounding and decoupling of power supplies as well as minimization or elimination of bus contention conditions during read and write cycles.
3. If G goes low coincident with or after W goes low, the output will remain in a high-impedance state.
4. All write cycle timing is referenced from the last valid address to the first transitioning address.
5. If \bar{E} goes low coincident with or after W goes low, the output will remain in a high-impedance condition.
6. If E goes high coincident with or before W goes high, the output will remain in a high-impedance condition.

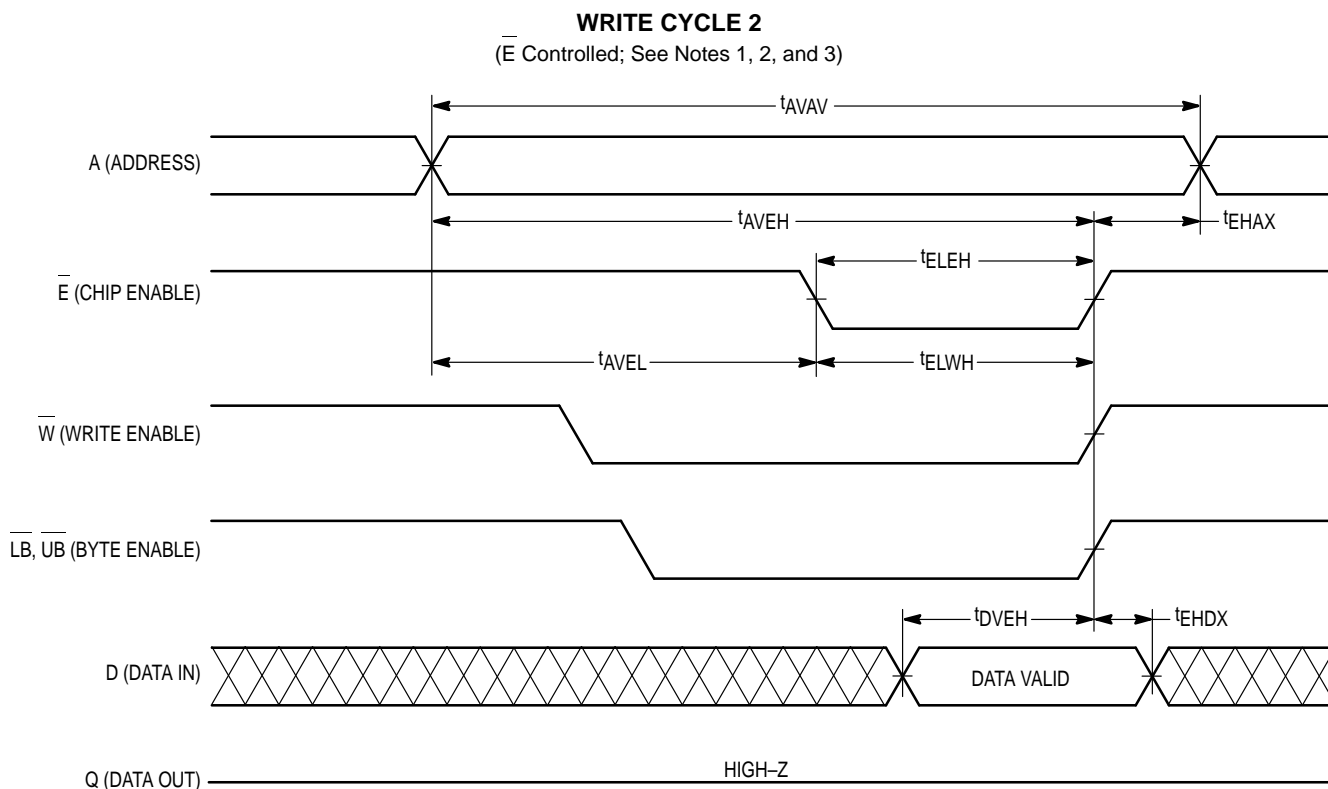

WRITE CYCLE 3 (\bar{E} Controlled; See Notes 1, 2, and 3)

Parameter	Symbol	MCM6343-12		MCM6343-15		Unit	Notes
		Min	Max	Min	Max		
Write Cycle Time	t_{AVAV}	12	—	15	—	ns	4
Address Setup Time	t_{AVBL}	0	—	0	—	ns	
Address Valid to End of Write	t_{AVBH}	10	—	12	—	ns	
Address Valid to End of Write (G High)	t_{AVBH}	9	—	10	—	ns	
Byte Pulse Width	t_{BLWH} t_{BLEH}	10	—	12	—	ns	
Byte Pulse Width (G High)	t_{BLWH} t_{BLEH}	9	—	10	—	ns	
Data Valid to End of Write	t_{DVBH}	6	—	7	—	ns	
Data Hold Time	t_{BHDX}	0	—	0	—	ns	

NOTES:

1. A write occurs during the overlap of \bar{E} low and \bar{W} low.
2. Product sensitivities to noise require proper grounding and decoupling of power supplies as well as minimization or elimination of bus contention conditions during read and write cycles.
3. If G goes low coincident with or after W goes low, the output will remain in a high-impedance state.
4. All write cycle timings are referenced from the last valid address to the first transitioning address.

WRITE CYCLE 3
(\bar{E} Controlled; See Notes 1, 2, and 3)

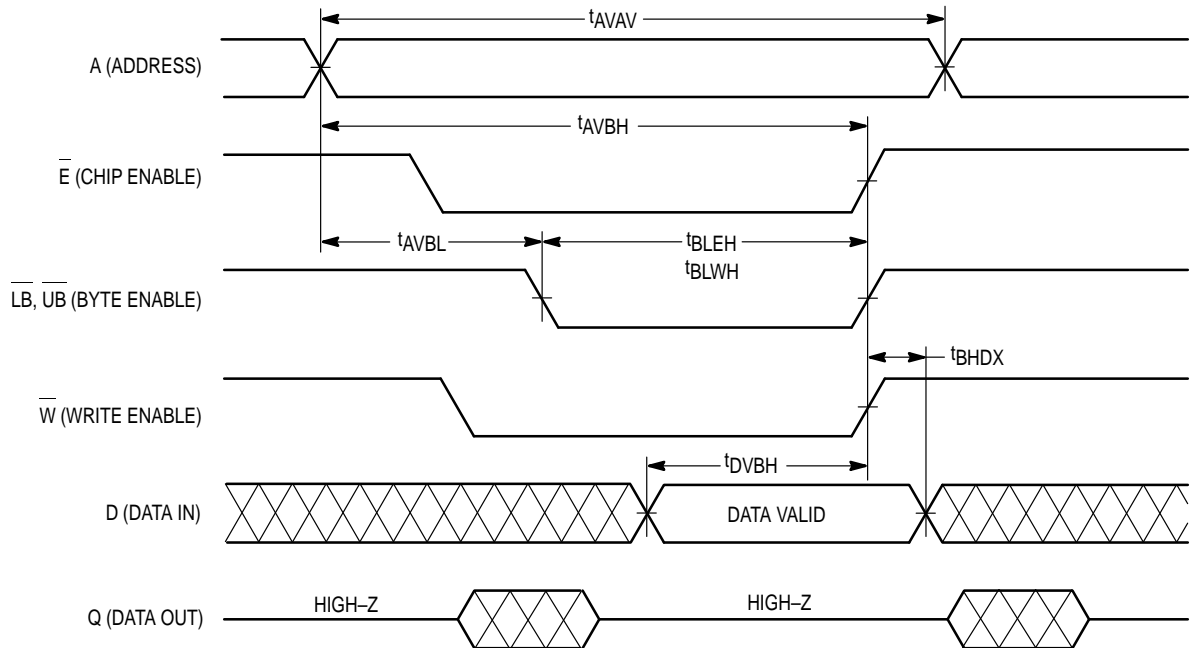

ORDERING INFORMATION (Order by Full Part Number)

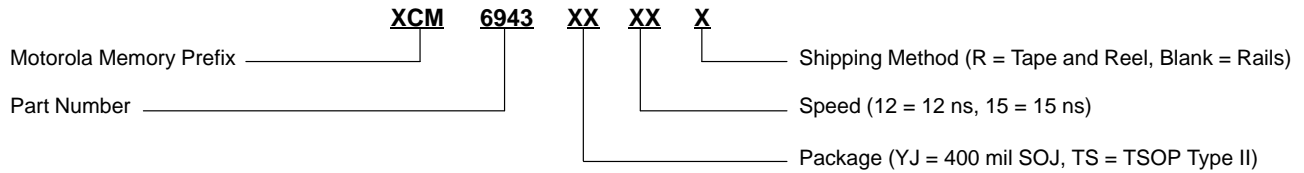

Full Commercial Part Numbers —	MCM6343YJ12	MCM6343YJ12R	MCM6343TS12
	MCM6343YJ15	MCM6343YJ15R	MCM6343TS15
Full Industrial Part Numbers —	SCM6343YJ12A	SCM6343YJ12AR	SCM6343TS12A*
	SCM6343YJ15A	SCM6343YJ15AR	SCM6343TS15A*

* Not available in Tape and Reel.

PACKAGE DIMENSIONS

**YJ PACKAGE
44-LEAD
400 MIL SOJ
CASE 919-01**

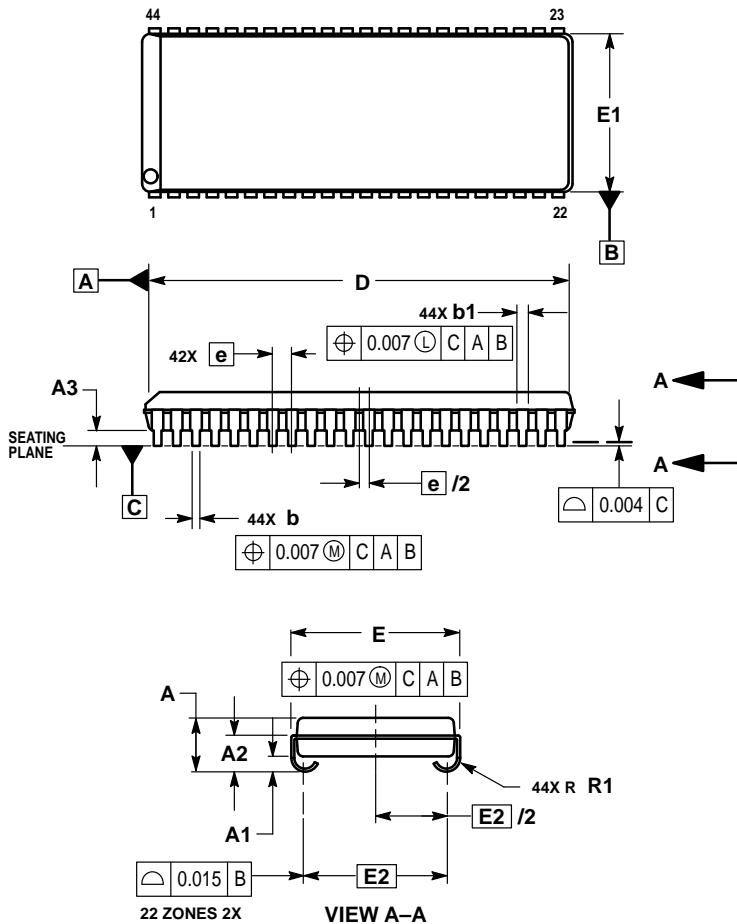

NOTES:

1. DIMENSIONING AND TOLERANCING PER ASME Y14.5M, 1994.
2. CONTROLLING DIMENSION: INCH.
3. DIMENSION D DOES NOT INCLUDE MOLD FLASH, TIE BAR BURRS AND GATE BURRS. MOLD FLASH, TIE BAR BURRS AND GATE BURRS SHALL NOT EXCEED 0.006 PER END. DIMENSION E1 DOES NOT INCLUDE INTERLEAD FLASH. INTERLEAD FLASH SHALL NOT EXCEED 0.010 PER SIDE.
4. THE PACKAGE TOP MAY BE SMALLER THAN THE PACKAGE BOTTOM. DIMENSIONS D AND E1 AND, HENCE, DATUMS A AND B, ARE DETERMINED AT THE OUTERMOST EXTREMES OF THE PLASTIC BODY EXCLUSIVE OF MOLD FLASH, TIE BAR BURRS, GATE BURRS AND INTERLEAD FLASH, BUT INCLUDING ANY MISMATCH BETWEEN THE TOP AND BOTTOM OF THE PLASTIC BODY.
5. DIMENSION b1 DOES NOT INCLUDE DAMBAR PROTRUSION OR INTRUSION. THE DAMBAR PROTRUSION(S) SHALL NOT CAUSE THE SHOULDER WIDTH TO EXCEED b1 MAX BY MORE THAN 0.005. THE DAMBAR INTRUSION(S) SHALL NOT REDUCE THE SHOULDER WIDTH TO LESS THAN 0.001 BELOW b1 MIN.

DIM	INCHES	
	MIN	MAX
A	0.128	0.148
A1	0.025	—
A2	0.082	—
A3	0.035	0.045
b	0.015	0.020
b1	0.026	0.032
D	1.120	1.130
E	0.435	0.445
E1	0.395	0.405
E2	0.370 BSC	
e	0.050 BSC	
R1	0.030	0.040

**TS PACKAGE
44-LEAD
TSOP TYPE II
CASE 924A-02**

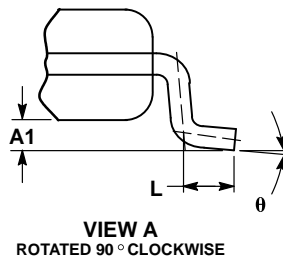
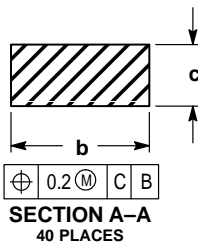
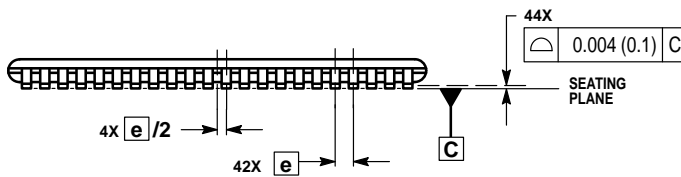
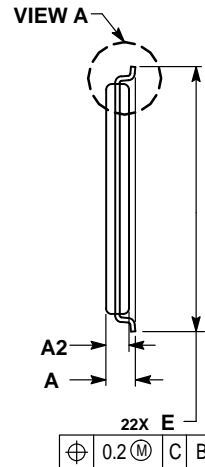
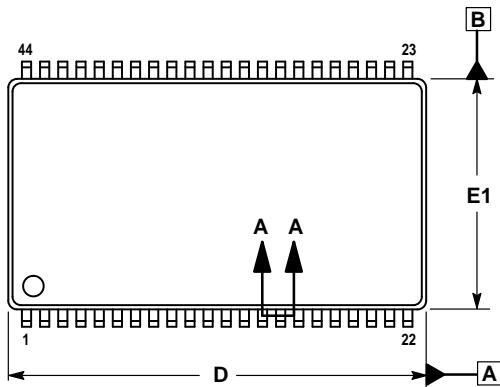

NOTES:

1. DIMENSIONS AND TOLERANCING PER ASME Y14.5M, 1994.
2. DIMENSIONS IN MILLIMETER.
3. DIMENSION D1 AND E1 DO NOT INCLUDE MOLD PROTRUSION. ALLOWABLE MOLD PROTRUSION IS 0.15 PER SIDE.
4. DIMENSION b DOES NOT INCLUDE DAMBAR PROTRUSIONS. DAMBAR PROTRUSION SHALL NOT CAUSE THE LEAD WIDTH TO EXCEED 0.58.

MILLIMETERS		
DIM	MIN	MAX
A	—	1.20
A1	0.05	0.15
A2	0.95	1.05
b	0.30	0.45
c	0.12	0.21
D	18.28	18.54
e	0.80 BSC	
E	11.56	11.96
E1	10.03	10.29
L	0.40	0.60
θ	0°	5°

Motorola reserves the right to make changes without further notice to any products herein. Motorola makes no warranty, representation or guarantee regarding the suitability of its products for any particular purpose, nor does Motorola assume any liability arising out of the application or use of any product or circuit, and specifically disclaims any and all liability, including without limitation consequential or incidental damages. "Typical" parameters which may be provided in Motorola data sheets and/or specifications can and do vary in different applications and actual performance may vary over time. All operating parameters, including "Typicals" must be validated for each customer application by customer's technical experts. Motorola does not convey any license under its patent rights nor the rights of others. Motorola products are not designed, intended, or authorized for use as components in systems intended for surgical implant into the body, or other applications intended to support or sustain life, or for any other application in which the failure of the Motorola product could create a situation where personal injury or death may occur. Should Buyer purchase or use Motorola products for any such unintended or unauthorized application, Buyer shall indemnify and hold Motorola and its officers, employees, subsidiaries, affiliates, and distributors harmless against all claims, costs, damages, and expenses, and reasonable attorney fees arising out of, directly or indirectly, any claim of personal injury or death associated with such unintended or unauthorized use, even if such claim alleges that Motorola was negligent regarding the design or manufacture of the part. Motorola and are registered trademarks of Motorola, Inc. Motorola, Inc. is an Equal Opportunity/Affirmative Action Employer.

Mfax is a trademark of Motorola, Inc.

How to reach us:

USA/EUROPE/Locations Not Listed: Motorola Literature Distribution;
P.O. Box 5405, Denver, Colorado, 80217. 1-303-675-2140 or 1-800-441-2447

JAPAN: Nippon Motorola Ltd.: SPD, Strategic Planning Office, 141,
4-32-1 Nishi-Gotanda, Shagawa-ku, Tokyo, Japan. 03-5487-8488

Mfax™: RMFAX0@email.sps.mot.com – TOUCHTONE 1-602-244-6609
Motorola Fax Back System – US & Canada ONLY 1-800-774-1848
– http://sps.motorola.com/mfax/

ASIA/PACIFIC: Motorola Semiconductors H.K. Ltd.; 8B Tai Ping Industrial Park,
51 Ting Kok Road, Tai Po, N.T., Hong Kong. 852-26629298

HOME PAGE: <http://motorola.com/sps/>

CUSTOMER FOCUS CENTER: 1-800-521-6274

