

Silicon Power Transistors

The MJ15023 and MJ15025 are PowerBase power transistors designed for high power audio, disk head positioners and other linear applications.

- High Safe Operating Area (100% Tested) —
2 A @ 80 V
- High DC Current Gain —
 $h_{FE} = 15$ (Min) @ $I_C = 8$ Adc

PNP
MJ15023
MJ15025*

*Motorola Preferred Device

16 AMPERE
SILICON
POWER TRANSISTORS
200 AND 250 VOLTS
250 WATTS

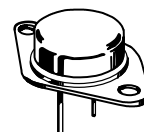

CASE 1-07
TO-204AA
(TO-3)

MAXIMUM RATINGS

Rating	Symbol	MJ15023	MJ15025	Unit
Collector-Emitter Voltage	V_{CEO}	200	250	Vdc
Collector-Base Voltage	V_{CB0}	350	400	Vdc
Emitter-Base Voltage	V_{EBO}	5		Vdc
Collector-Emitter Voltage	V_{CEX}	400		Vdc
Collector Current — Continuous Peak (1)	I_C	16 30		Adc
Base Current — Continuous	I_B	5		Adc
Total Power Dissipation @ $T_C = 25^\circ\text{C}$ Derate above 25°C	P_D	250 1.43		Watts W/ $^\circ\text{C}$
Operating and Storage Junction Temperature Range	T_J, T_{stg}	-65 to +200		$^\circ\text{C}$

THERMAL CHARACTERISTICS

Characteristic	Symbol	Max	Unit
Thermal Resistance, Junction to Case	$R_{\theta JC}$	0.70	$^\circ\text{C/W}$

(1) Pulse Test: Pulse Width = 5 ms, Duty Cycle \leq 10%.

Preferred devices are Motorola recommended choices for future use and best overall value.

REV 7

MJ15023 MJ15025

ELECTRICAL CHARACTERISTICS (T_C = 25°C unless otherwise noted)

Characteristic	Symbol	Min	Max	Unit
OFF CHARACTERISTICS				
Collector–Emitter Sustaining Voltage (1) (I _C = 100 mAdc, I _B = 0)	MJ15023 MJ15025	V _{CEO(sus)}	200 250	—
Collector Cutoff Current (V _{CE} = 200 Vdc, V _{BE(off)} = 1.5 Vdc) (V _{CE} = 250 Vdc, V _{BE(off)} = 1.5 Vdc)	MJ15023 MJ15025	I _{CEX}	— —	250 250
Collector Cutoff Current (V _{CE} = 150 Vdc, I _B = 0) (V _{CE} = 200 Vdc, I _B = 0)	MJ15023 MJ15025	I _{CEO}	— —	500 500
Emitter Cutoff Current (V _{CE} = 5 Vdc, I _B = 0)	Both	I _{EBO}	—	500

SECOND BREAKDOWN

Second Breakdown Collector Current with Base Forward Biased (V _{CE} = 50 Vdc, t = 0.5 s (non-repetitive)) (V _{CE} = 80 Vdc, t = 0.5 s (non-repetitive))	I _{S/b}	5 2	— —	Adc
---	------------------	--------	--------	-----

ON CHARACTERISTICS

DC Current Gain (I _C = 8 Adc, V _{CE} = 4 Vdc) (I _C = 16 Adc, V _{CE} = 4 Vdc)	h _{FE}	15 5	60 —	—
Collector–Emitter Saturation Voltage (I _C = 8 Adc, I _B = 0.8 Adc) (I _C = 16 Adc, I _B = 3.2 Adc)	V _{CE(sat)}	—	1.4 4.0	Vdc
Base–Emitter On Voltage (I _C = 8 Adc, V _{CE} = 4 Vdc)	V _{BE(on)}	—	2.2	Vdc

DYNAMIC CHARACTERISTICS

Current–Gain — Bandwidth Product (I _C = 1 Adc, V _{CE} = 10 Vdc, f _{test} = 1 MHz)	f _T	4	—	MHz
Output Capacitance (V _{CB} = 10 Vdc, I _E = 0, f _{test} = 1 MHz)	C _{ob}	—	600	pF

(1) Pulse Test: Pulse Width = 300 μs, Duty Cycle ≤ 2%.

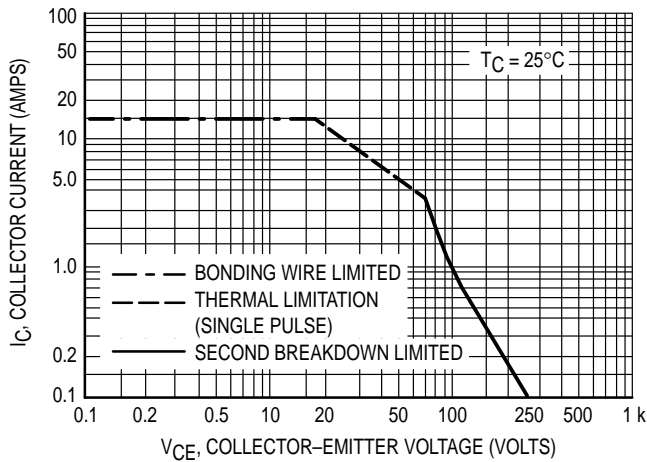

Figure 1. Active–Region Safe Operating Area

There are two limitations on the powerhandling ability of a transistor: average junction temperature and second breakdown. Safe operating area curves indicate I_C – V_{CE} limits of the transistor that must be observed for reliable operation; i.e., the transistor must not be subjected to greater dissipation than the curves indicate.

The data of Figure 1 is based on T_{J(pk)} = 200°C; T_C is variable depending on conditions. At high case temperatures, thermal limitations will reduce the power that can be handled to values less than the limitations imposed by second breakdown.

TYPICAL CHARACTERISTICS

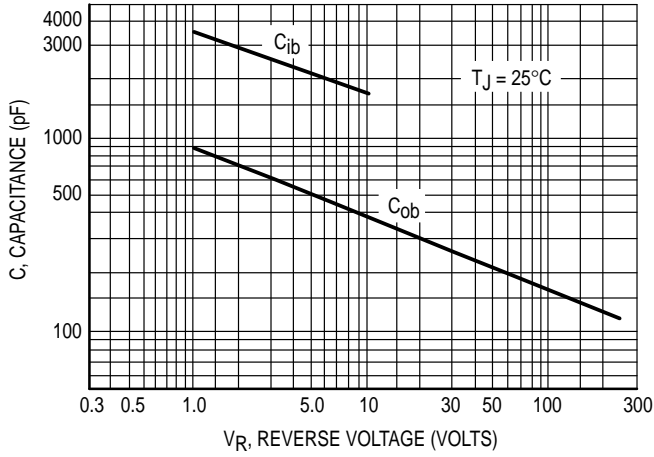

Figure 2. Capacitances

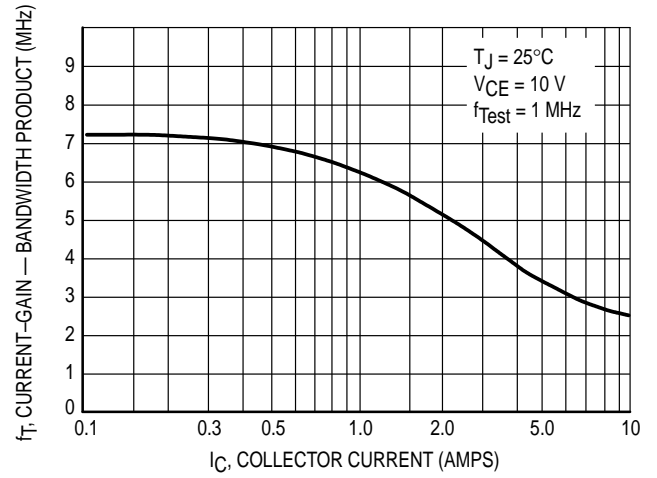

Figure 3. Current-Gain — Bandwidth Product

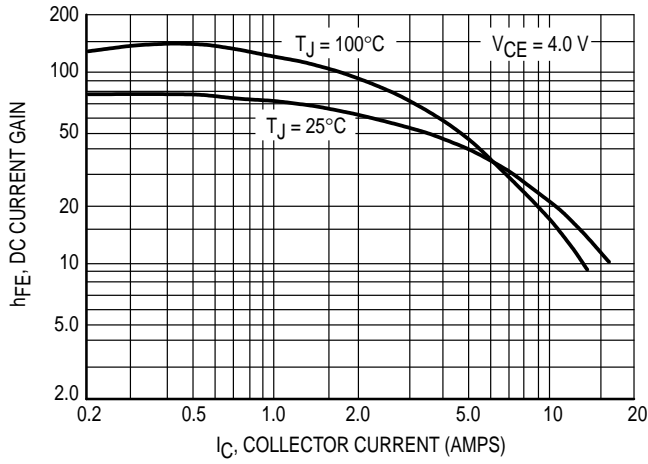

Figure 4. DC Current Gain

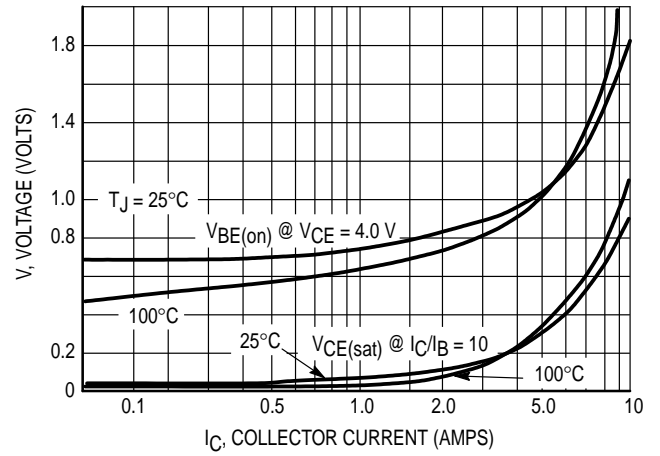
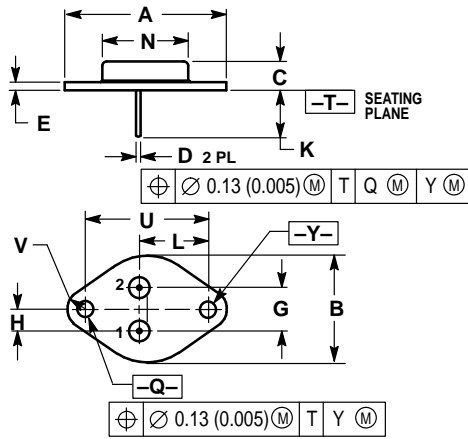

Figure 5. "On" Voltages

PACKAGE DIMENSIONS



- NOTES:
1. DIMENSIONING AND TOLERANCING PER ANSI Y14.5M, 1982.
 2. CONTROLLING DIMENSION: INCH.
 3. ALL RULES AND NOTES ASSOCIATED WITH REFERENCED TO-204AA OUTLINE SHALL APPLY.

DIM	INCHES		MILLIMETERS	
	MIN	MAX	MIN	MAX
A	1.550 REF		39.37 REF	
B	—	1.050	—	26.67
C	0.250	0.335	6.35	8.51
D	0.038	0.043	0.97	1.09
E	0.055	0.070	1.40	1.77
G	0.430 BSC		10.92 BSC	
H	0.215 BSC		5.46 BSC	
K	0.440	0.480	11.18	12.19
L	0.665 BSC		16.89 BSC	
N	—	0.830	—	21.08
Q	0.151	0.165	3.84	4.19
U	1.187 BSC		30.15 BSC	
V	0.131	0.188	3.33	4.77

- STYLE 1:
1. BASE
 2. EMITTER
- CASE: COLLECTOR

CASE 1-07
TO-204AA (TO-3)
ISSUE Z

Motorola reserves the right to make changes without further notice to any products herein. Motorola makes no warranty, representation or guarantee regarding the suitability of its products for any particular purpose, nor does Motorola assume any liability arising out of the application or use of any product or circuit, and specifically disclaims any and all liability, including without limitation consequential or incidental damages. "Typical" parameters can and do vary in different applications. All operating parameters, including "Typicals" must be validated for each customer application by customer's technical experts. Motorola does not convey any license under its patent rights nor the rights of others. Motorola products are not designed, intended, or authorized for use as components in systems intended for surgical implant into the body, or other applications intended to support or sustain life, or for any other application in which the failure of the Motorola product could create a situation where personal injury or death may occur. Should Buyer purchase or use Motorola products for any such unintended or unauthorized application, Buyer shall indemnify and hold Motorola and its officers, employees, subsidiaries, affiliates, and distributors harmless against all claims, costs, damages, and expenses, and reasonable attorney fees arising out of, directly or indirectly, any claim of personal injury or death associated with such unintended or unauthorized use, even if such claim alleges that Motorola was negligent regarding the design or manufacture of the part. Motorola and are registered trademarks of Motorola, Inc. Motorola, Inc. is an Equal Opportunity/Affirmative Action Employer.

How to reach us:
USA / EUROPE: Motorola Literature Distribution;
P.O. Box 20912; Phoenix, Arizona 85036. 1-800-441-2447

JAPAN: Nippon Motorola Ltd.; Tatsumi-SPD-JLDC, Toshikatsu Otsuki,
6F Seibu-Butsuryu-Center, 3-14-2 Tatsumi Koto-Ku, Tokyo 135, Japan. 03-3521-8315

MFAX: RMFAX0@email.sps.mot.com - TOUCHTONE (602) 244-6609
INTERNET: http://Design-NET.com

HONG KONG: Motorola Semiconductors H.K. Ltd.; 8B Tai Ping Industrial Park,
51 Ting Kok Road, Tai Po, N.T., Hong Kong. 852-26629298

