

# Complementary Silicon Power Transistors

... designed for general-purpose switching and amplifier applications.

- DC Current Gain —  $h_{FE} = 20-70 @ I_C = 4 \text{ Adc}$
- Collector-Emitter Saturation Voltage —  
 $V_{CE(sat)} = 1.1 \text{ Vdc (Max) @ } I_C = 4 \text{ Adc}$
- Excellent Safe Operating Area

## MAXIMUM RATINGS

Rating	Symbol	Value	Unit
Collector-Emitter Voltage	$V_{CEO}$	60	Vdc
Collector-Emitter Voltage	$V_{CER}$	70	Vdc
Collector-Base Voltage	$V_{CB}$	100	Vdc
Emitter-Base Voltage	$V_{EB}$	7	Vdc
Collector Current — Continuous	$I_C$	15	A <sub>dc</sub>
Base Current	$I_B$	7	A <sub>dc</sub>
Total Power Dissipation @ $T_C = 25^\circ\text{C}$ Derate above $25^\circ\text{C}$	$P_D$	115 0.657	Watts W/ $^\circ\text{C}$
Operating and Storage Junction Temperature Range	$T_J, T_{stg}$	-65 to +200	$^\circ\text{C}$

## THERMAL CHARACTERISTICS

Characteristic	Symbol	Max	Unit
Thermal Resistance, Junction to Case	$R_{\theta JC}$	1.52	$^\circ\text{C/W}$

**NPN**  
**2N3055 \***  
**PNP**  
**MJ2955 \***

\*Motorola Preferred Device

**15 AMPERE**  
**POWER TRANSISTORS**  
**COMPLEMENTARY**  
**SILICON**  
**60 VOLTS**  
**115 WATTS**

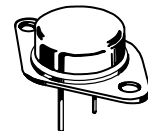

**CASE 1-07**  
**TO-204AA**  
**(TO-3)**

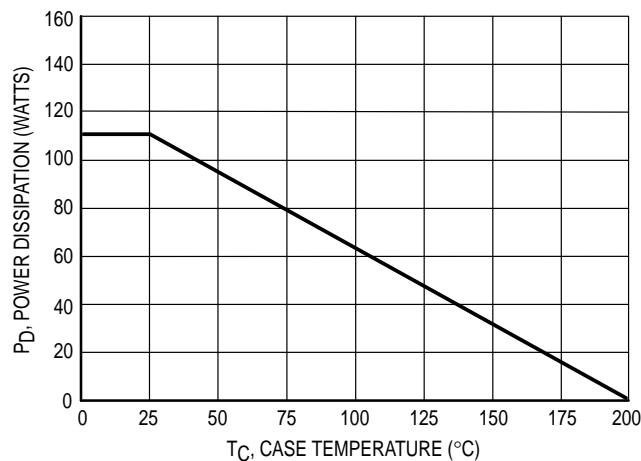

**Figure 1. Power Derating**

Preferred devices are Motorola recommended choices for future use and best overall value.

## 2N3055 MJ2955

### ELECTRICAL CHARACTERISTICS ( $T_C = 25^\circ\text{C}$ unless otherwise noted)

Characteristic	Symbol	Min	Max	Unit
<b>*OFF CHARACTERISTICS</b>				
Collector–Emitter Sustaining Voltage (1) ( $I_C = 200\text{ mA}$ , $I_B = 0$ )	$V_{CEO(sus)}$	60	—	Vdc
Collector–Emitter Sustaining Voltage (1) ( $I_C = 200\text{ mA}$ , $R_{BE} = 100\text{ Ohms}$ )	$V_{CER(sus)}$	70	—	Vdc
Collector Cutoff Current ( $V_{CE} = 30\text{ Vdc}$ , $I_B = 0$ )	$I_{CEO}$	—	0.7	mA
Collector Cutoff Current ( $V_{CE} = 100\text{ Vdc}$ , $V_{BE(off)} = 1.5\text{ Vdc}$ ) ( $V_{CE} = 100\text{ Vdc}$ , $V_{BE(off)} = 1.5\text{ Vdc}$ , $T_C = 150^\circ\text{C}$ )	$I_{CEX}$	—	1.0 5.0	mA
Emitter Cutoff Current ( $V_{BE} = 7.0\text{ Vdc}$ , $I_C = 0$ )	$I_{EBO}$	—	5.0	mA

### \*ON CHARACTERISTICS (1)

DC Current Gain ( $I_C = 4.0\text{ Adc}$ , $V_{CE} = 4.0\text{ Vdc}$ ) ( $I_C = 10\text{ Adc}$ , $V_{CE} = 4.0\text{ Vdc}$ )	$h_{FE}$	20 5.0	70 —	—
Collector–Emitter Saturation Voltage ( $I_C = 4.0\text{ Adc}$ , $I_B = 400\text{ mA}$ ) ( $I_C = 10\text{ Adc}$ , $I_B = 3.3\text{ Adc}$ )	$V_{CE(sat)}$	—	1.1 3.0	Vdc
Base–Emitter On Voltage ( $I_C = 4.0\text{ Adc}$ , $V_{CE} = 4.0\text{ Vdc}$ )	$V_{BE(on)}$	—	1.5	Vdc

### SECOND BREAKDOWN

Second Breakdown Collector Current with Base Forward Biased ( $V_{CE} = 40\text{ Vdc}$ , $t = 1.0\text{ s}$ , Nonrepetitive)	$I_{s/b}$	2.87	—	A
---	-----------	------	---	---

### DYNAMIC CHARACTERISTICS

Current Gain — Bandwidth Product ( $I_C = 0.5\text{ Adc}$ , $V_{CE} = 10\text{ Vdc}$ , $f = 1.0\text{ MHz}$ )	$f_T$	2.5	—	MHz
*Small–Signal Current Gain ( $I_C = 1.0\text{ Adc}$ , $V_{CE} = 4.0\text{ Vdc}$ , $f = 1.0\text{ kHz}$ )	$h_{fe}$	15	120	—
*Small–Signal Current Gain Cutoff Frequency ( $V_{CE} = 4.0\text{ Vdc}$ , $I_C = 1.0\text{ Adc}$ , $f = 1.0\text{ kHz}$ )	$f_{hfe}$	10	—	kHz

\* Indicates Within JEDEC Registration. (2N3055)

(1) Pulse Test: Pulse Width  $\leq 300\text{ }\mu\text{s}$ , Duty Cycle  $\leq 2.0\%$ .

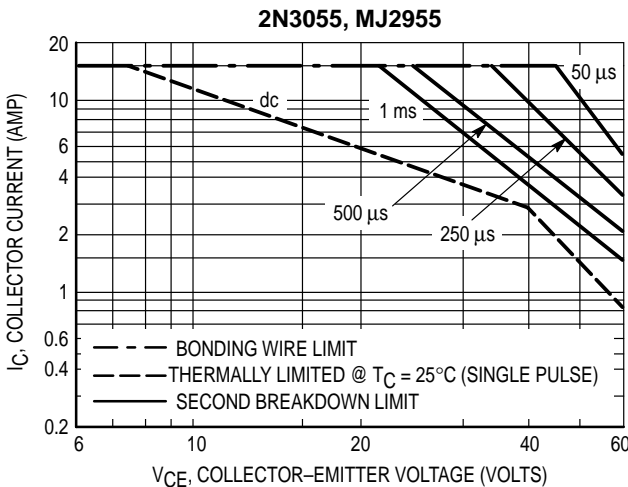

There are two limitations on the power handling ability of a transistor: average junction temperature and second breakdown. Safe operating area curves indicate  $I_C - V_{CE}$  limits of the transistor that must be observed for reliable operation; i.e., the transistor must not be subjected to greater dissipation than the curves indicate.

The data of Figure 2 is based on  $T_C = 25^\circ\text{C}$ ;  $T_{J(pk)}$  is variable depending on power level. Second breakdown pulse limits are valid for duty cycles to 10% but must be derated for temperature according to Figure 1.

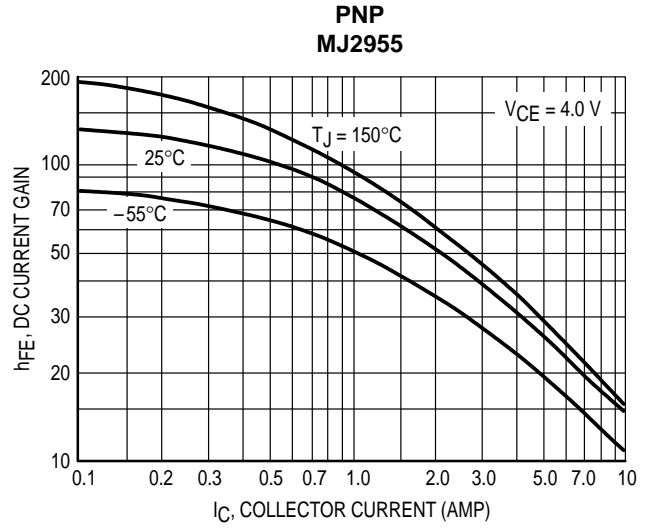
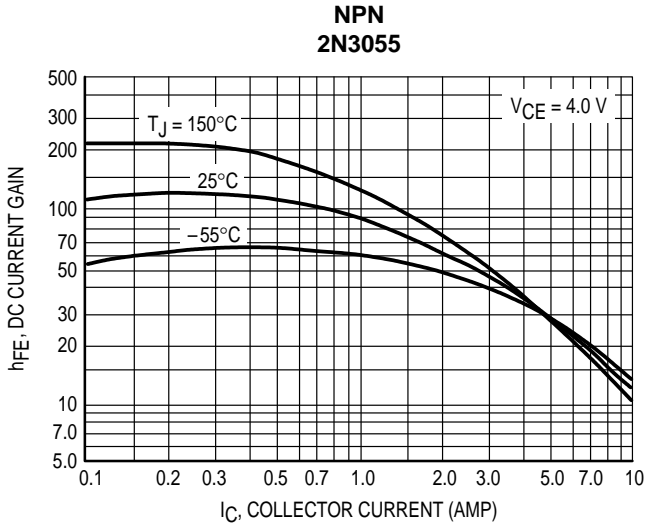

Figure 3. DC Current Gain

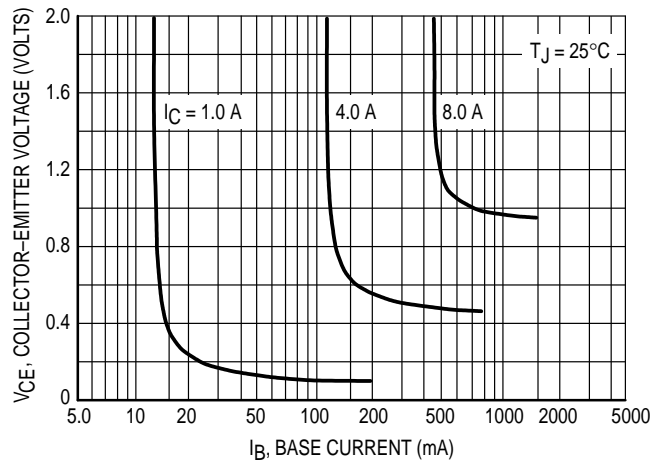
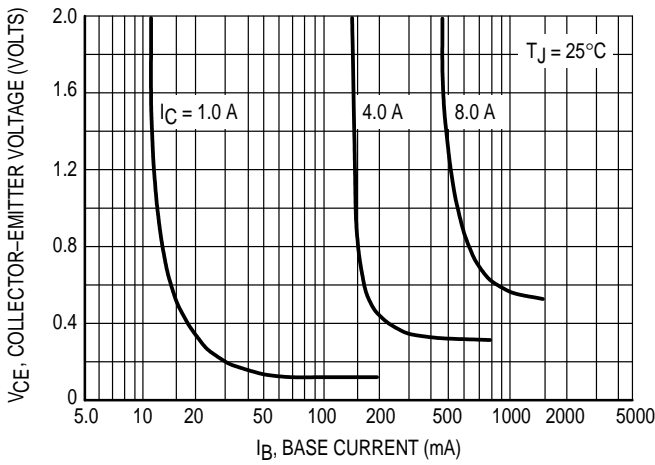

Figure 4. Collector Saturation Region

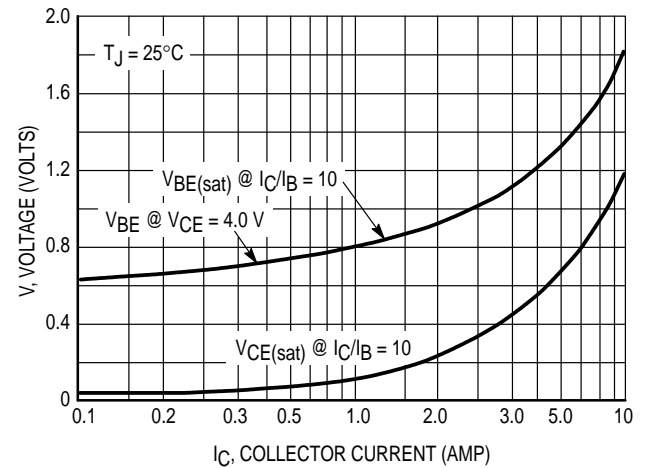
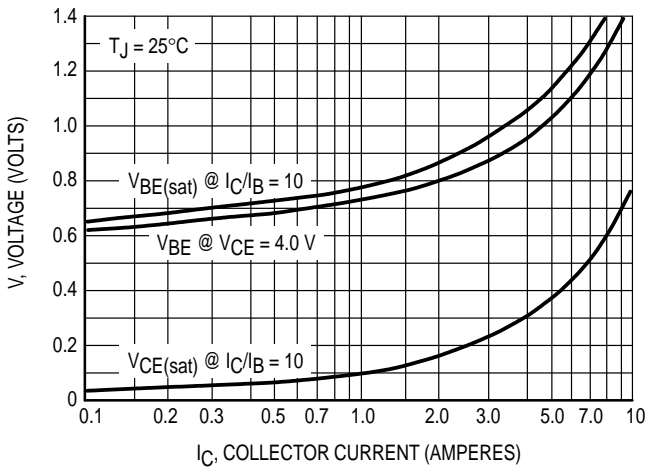
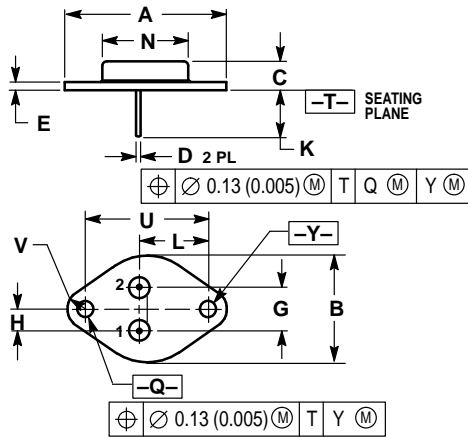

Figure 5. "On" Voltages

PACKAGE DIMENSIONS



- NOTES:
1. DIMENSIONING AND TOLERANCING PER ANSI Y14.5M, 1982.
  2. CONTROLLING DIMENSION: INCH.
  3. ALL RULES AND NOTES ASSOCIATED WITH REFERENCED TO-204AA OUTLINE SHALL APPLY.

DIM	INCHES		MILLIMETERS	
	MIN	MAX	MIN	MAX
A	1.550 REF		39.37 REF	
B	—	1.050	—	26.67
C	0.250	0.335	6.35	8.51
D	0.038	0.043	0.97	1.09
E	0.055	0.070	1.40	1.77
G	0.430 BSC		10.92 BSC	
H	0.215 BSC		5.46 BSC	
K	0.440	0.480	11.18	12.19
L	0.665 BSC		16.89 BSC	
N	—	0.830	—	21.08
Q	0.151	0.165	3.84	4.19
U	1.187 BSC		30.15 BSC	
V	0.131	0.188	3.33	4.77

STYLE 1:  
 PIN 1: BASE  
 2: EMITTER  
 CASE: COLLECTOR

CASE 1-07  
 TO-204AA (TO-3)  
 ISSUE Z

Motorola reserves the right to make changes without further notice to any products herein. Motorola makes no warranty, representation or guarantee regarding the suitability of its products for any particular purpose, nor does Motorola assume any liability arising out of the application or use of any product or circuit, and specifically disclaims any and all liability, including without limitation consequential or incidental damages. "Typical" parameters can and do vary in different applications. All operating parameters, including "Typicals" must be validated for each customer application by customer's technical experts. Motorola does not convey any license under its patent rights nor the rights of others. Motorola products are not designed, intended, or authorized for use as components in systems intended for surgical implant into the body, or other applications intended to support or sustain life, or for any other application in which the failure of the Motorola product could create a situation where personal injury or death may occur. Should Buyer purchase or use Motorola products for any such unintended or unauthorized application, Buyer shall indemnify and hold Motorola and its officers, employees, subsidiaries, affiliates, and distributors harmless against all claims, costs, damages, and expenses, and reasonable attorney fees arising out of, directly or indirectly, any claim of personal injury or death associated with such unintended or unauthorized use, even if such claim alleges that Motorola was negligent regarding the design or manufacture of the part. Motorola and are registered trademarks of Motorola, Inc. Motorola, Inc. is an Equal Opportunity/Affirmative Action Employer.

How to reach us:  
 USA / EUROPE: Motorola Literature Distribution;  
 P.O. Box 20912; Phoenix, Arizona 85036. 1-800-441-2447

JAPAN: Nippon Motorola Ltd.; Tatsumi-SPD-JLDC, Toshikatsu Otsuki,  
 6F Seibu-Butsuryu-Center, 3-14-2 Tatsumi Koto-Ku, Tokyo 135, Japan. 03-3521-8315

MFAX: RMFAX0@email.sps.mot.com - TOUCHTONE (602) 244-6609  
 INTERNET: http://Design-NET.com

HONG KONG: Motorola Semiconductors H.K. Ltd.; 8B Tai Ping Industrial Park,  
 51 Ting Kok Road, Tai Po, N.T., Hong Kong. 852-26629298

