

Switching Transistors

PNP Silicon

MPS3638,A

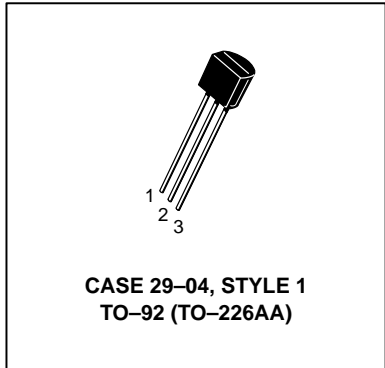
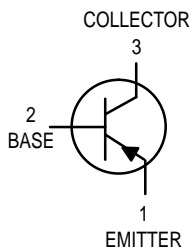

MAXIMUM RATINGS

Rating	Symbol	Value	Unit
Collector–Emitter Voltage	V_{CEO}	–25	Vdc
Collector–Emitter Voltage	V_{CES}	–25	Vdc
Collector–Base Voltage	V_{CBO}	–25	Vdc
Emitter–Base Voltage	V_{EBO}	–4.0	Vdc
Collector Current — Continuous	I_C	–500	mAdc
Total Device Dissipation @ $T_A = 25^\circ\text{C}$ Derate above 25°C	P_D	625 5.0	mW mW/ $^\circ\text{C}$
Total Device Dissipation @ $T_C = 25^\circ\text{C}$ Derate above 25°C	P_D	1.5 12	Watts mW/ $^\circ\text{C}$
Operating and Storage Junction Temperature Range	T_J, T_{stg}	–55 to +150	$^\circ\text{C}$

THERMAL CHARACTERISTICS

Characteristic	Symbol	Max	Unit
Thermal Resistance, Junction to Ambient	$R_{\theta JA}^{(1)}$	200	$^\circ\text{C}/\text{W}$
Thermal Resistance, Junction to Case	$R_{\theta JC}$	83.3	$^\circ\text{C}/\text{W}$

ELECTRICAL CHARACTERISTICS ($T_A = 25^\circ\text{C}$ unless otherwise noted)

Characteristic	Symbol	Min	Max	Unit
----------------	--------	-----	-----	------

OFF CHARACTERISTICS

Collector–Emitter Breakdown Voltage ($I_C = -100 \mu\text{Adc}, V_{BE} = 0$)	$V_{(BR)CES}$	–25	—	Vdc
Collector–Emitter Sustaining Voltage ⁽²⁾ ($I_C = -10 \text{ mAdc}, I_B = 0$)	$V_{CEO(sus)}$	–25	—	Vdc
Collector–Base Breakdown Voltage ($I_C = -100 \mu\text{Adc}, I_E = 0$)	$V_{(BR)CBO}$	–25	—	Vdc
Emitter–Base Breakdown Voltage ($I_E = -100 \mu\text{Adc}, I_C = 0$)	$V_{(BR)EBO}$	–4.0	—	Vdc
Collector Cutoff Current ($V_{CE} = -15 \text{ Vdc}, V_{BE} = 0$) ($V_{CE} = -15 \text{ Vdc}, V_{BE} = 0, T_A = -65^\circ\text{C}$)	I_{CES}	—	–0.035 –2.0	μAdc
Emitter Cutoff Current ($V_{EB} = -3.0 \text{ V}, I_C = 0$)	I_{EBO}	—	–35	nA
Base Current ($V_{CE} = -15 \text{ Vdc}, V_{BE} = 0$)	I_B	—	–0.035	μAdc

- $R_{\theta JA}$ is measured with the device soldered into a typical printed circuit board.
- Pulse Test: Pulse Width $\leq 300 \mu\text{s}$; Duty Cycle $\leq 2.0\%$.

MPS3638,A

ELECTRICAL CHARACTERISTICS ($T_A = 25^\circ\text{C}$ unless otherwise noted) (Continued)

Characteristic	Symbol	Min	Max	Unit
ON CHARACTERISTICS(2)				
DC Current Gain ($I_C = -1.0\text{ mAdc}$, $V_{CE} = -10\text{ Vdc}$)	h_{FE}	80	—	—
	MPS3638A			
($I_C = -10\text{ mAdc}$, $V_{CE} = -10\text{ Vdc}$)		20	—	
	MPS3638			
	MPS3638A	100	—	
($I_C = -50\text{ mAdc}$, $V_{CE} = -1.0\text{ Vdc}$)		30	—	
	MPS3638			
	MPS3638A	100	—	
($I_C = -300\text{ mAdc}$, $V_{CE} = -2.0\text{ Vdc}$)		20	—	
	MPS3638			
	MPS3638A	20	—	
Collector–Emitter Saturation Voltage ($I_C = -50\text{ mAdc}$, $I_B = -2.5\text{ mAdc}$) ($I_C = -300\text{ mAdc}$, $I_B = -30\text{ mAdc}$)	$V_{CE(sat)}$	—	-0.25	Vdc
		—	-1.0	
Base–Emitter Saturation Voltage ($I_C = -50\text{ mAdc}$, $I_B = -2.5\text{ mAdc}$) ($I_C = -300\text{ mAdc}$, $I_B = -30\text{ mAdc}$)	$V_{BE(sat)}$	—	-1.1	Vdc
		-0.80	-2.0	

SMALL–SIGNAL CHARACTERISTICS

Current–Gain — Bandwidth Product ($V_{CE} = -3.0\text{ Vdc}$, $I_C = -50\text{ mAdc}$, $f = 100\text{ MHz}$)	f_T	100	—	MHz
		150	—	
	MPS3638			
	MPS3638A			
Output Capacitance ($V_{CB} = -10\text{ Vdc}$, $I_E = 0$, $f = 1.0\text{ MHz}$)	C_{obo}	—	20	pF
		—	10	
	MPS3638			
	MPS3638A			
Input Capacitance ($V_{EB} = -0.5\text{ Vdc}$, $I_C = 0$, $f = 1.0\text{ MHz}$)	C_{ibo}	—	65	pF
		—	25	
	MPS3638			
	MPS3638A			
Input Impedance ($I_C = -10\text{ mAdc}$, $V_{CE} = -10\text{ Vdc}$, $f = 1.0\text{ kHz}$)	h_{ie}	—	2000	k Ω
Voltage Feedback Ratio ($I_C = -10\text{ mAdc}$, $V_{CE} = -10\text{ Vdc}$, $f = 1.0\text{ kHz}$)	h_{re}	—	26	$\times 10^{-4}$
		—	15	
	MPS3638			
	MPS3638A			
Small–Signal Current Gain ($I_C = -10\text{ mAdc}$, $V_{CE} = -10\text{ Vdc}$, $f = 1.0\text{ kHz}$)	h_{fe}	25	—	—
		100	—	
	MPS3638			
	MPS3638A			
Output Admittance ($I_C = -10\text{ mAdc}$, $V_{CE} = -10\text{ Vdc}$, $f = 1.0\text{ kHz}$)	h_{oe}	—	1.2	mmhos

SWITCHING CHARACTERISTICS

Delay Time	$(V_{CC} = -10\text{ Vdc}$, $I_C = -300\text{ mAdc}$, $I_{B1} = -30\text{ mAdc}$)	t_d	—	20	ns
Rise Time		t_r	—	70	ns
Storage Time	$(V_{CC} = -10\text{ Vdc}$, $I_C = -300\text{ mAdc}$, $I_{B1} = -30\text{ mAdc}$, $I_{B2} = -30\text{ mAdc}$)	t_s	—	140	ns
Fall Time		t_f	—	70	ns
Turn–On Time	$(I_C = -300\text{ mAdc}$, $I_{B1} = -30\text{ mAdc}$)	t_{on}	—	75	ns
Turn–Off Time	$(I_C = -300\text{ mAdc}$, $I_{B1} = -30\text{ mAdc}$, $I_{B2} = 30\text{ mAdc}$)	t_{off}	—	170	ns

2. Pulse Test: Pulse Width $\leq 300\ \mu\text{s}$; Duty Cycle $\leq 2.0\%$.

SWITCHING TIME EQUIVALENT TEST CIRCUIT

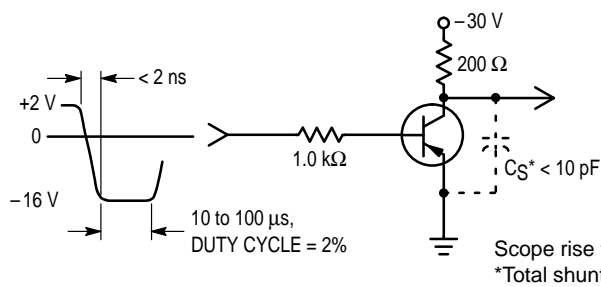

Figure 1. Turn-On Time

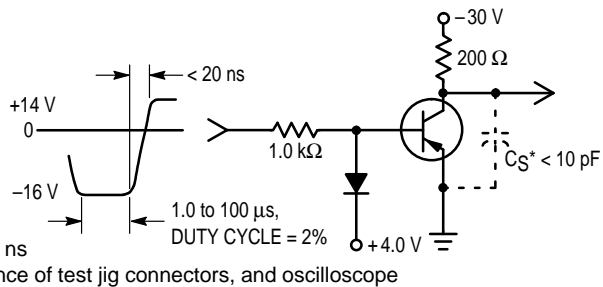

Figure 2. Turn-Off Time

TRANSIENT CHARACTERISTICS

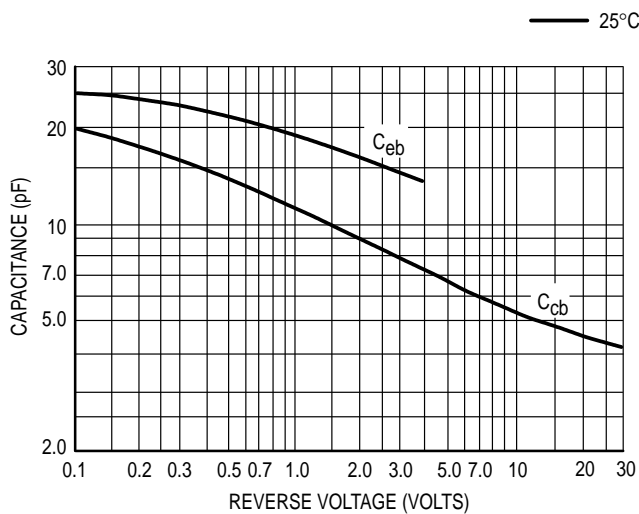

Figure 3. Capacitances

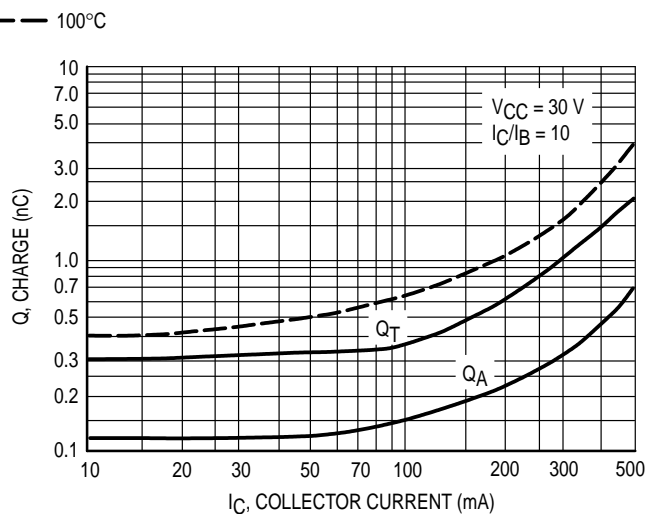

Figure 4. Charge Data

TRANSIENT CHARACTERISTICS (Continued)

— 25°C - - - 100°C

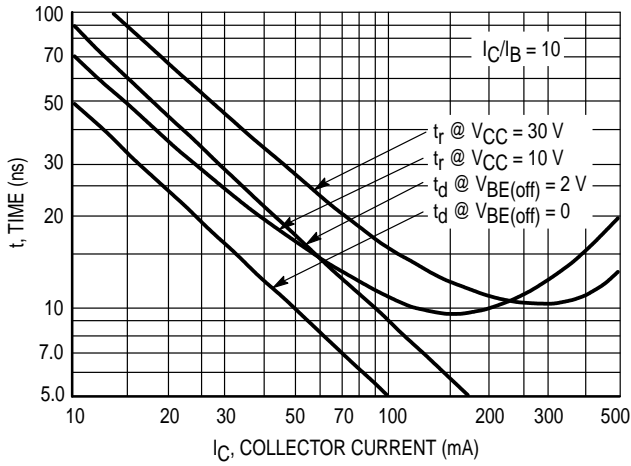

Figure 5. Turn-On Time

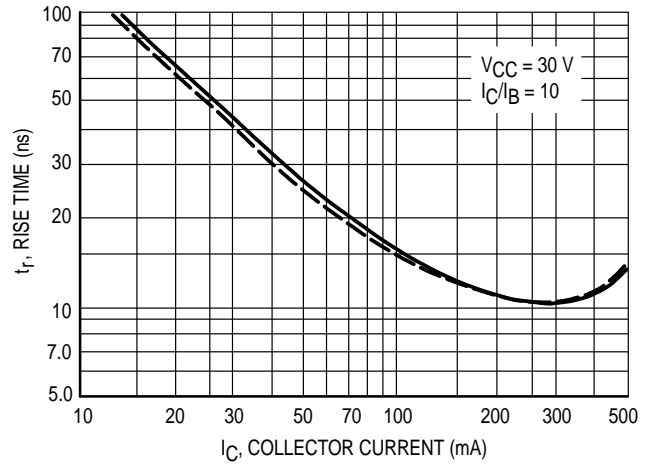

Figure 6. Rise Time

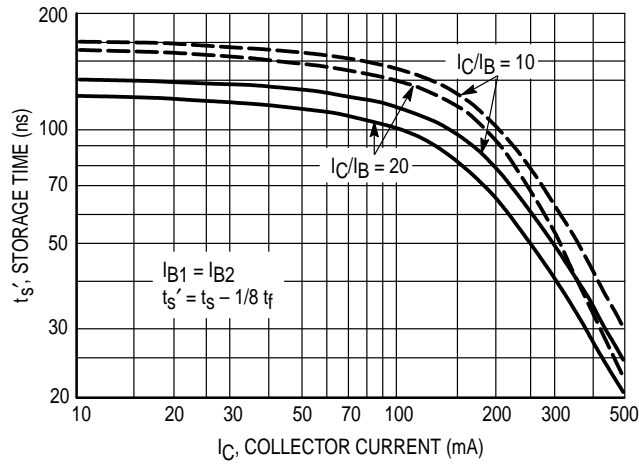

Figure 7. Storage Time

SMALL-SIGNAL CHARACTERISTICS

NOISE FIGURE

$V_{CE} = -10 \text{ Vdc}$, $T_A = 25^\circ\text{C}$

Bandwidth = 1.0 Hz

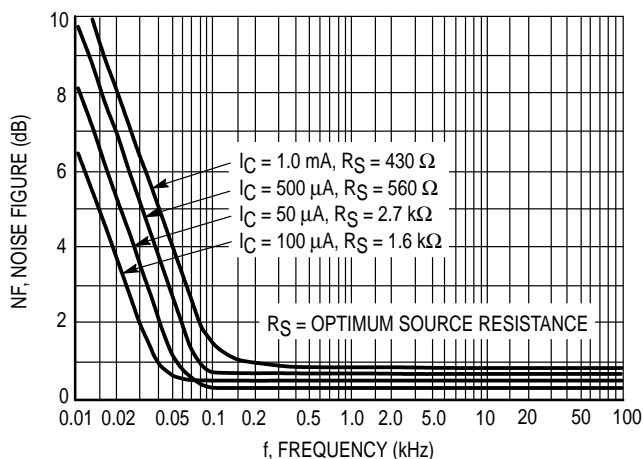

Figure 8. Frequency Effects

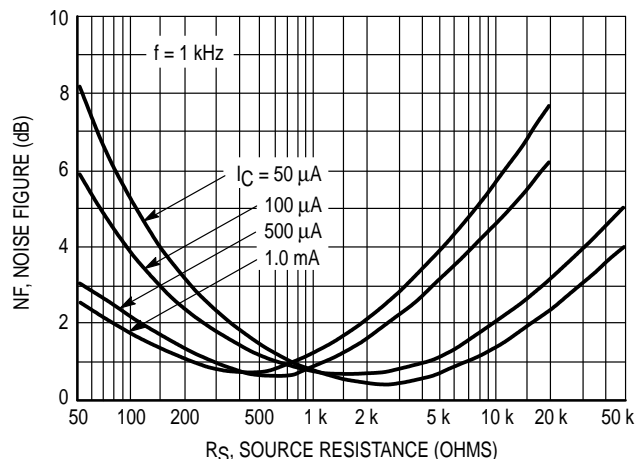

Figure 9. Source Resistance Effects

h PARAMETERS

$V_{CE} = -10 \text{ Vdc}$, $f = 1.0 \text{ kHz}$, $T_A = 25^\circ\text{C}$

This group of graphs illustrates the relationship between h_{fe} and other "h" parameters for this series of transistors. To obtain these curves, a high-gain and a low-gain unit were

selected from both the 2N4402 and 2N4403 lines, and the same units were used to develop the correspondingly-numbered curves on each graph.

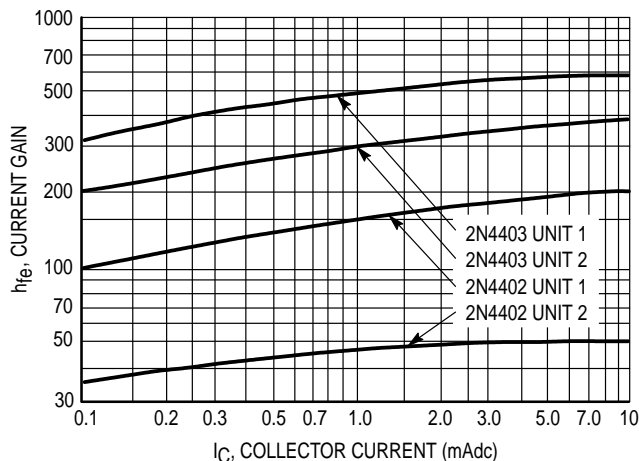

Figure 10. Current Gain

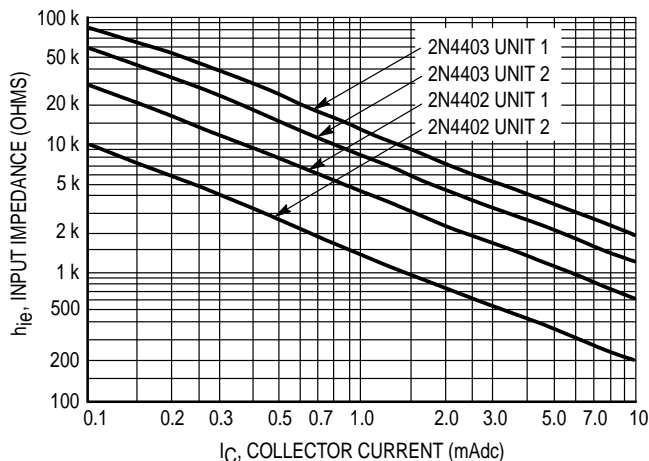

Figure 11. Input Impedance

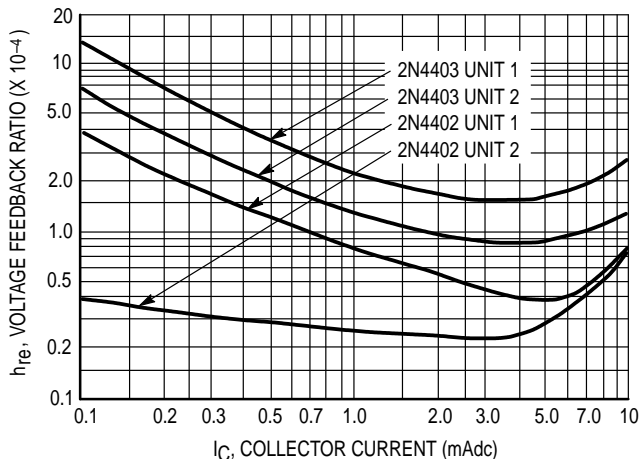

Figure 12. Voltage Feedback Ratio

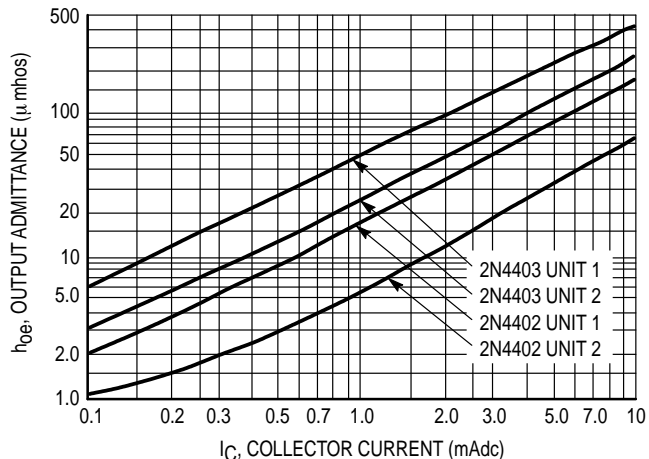

Figure 13. Output Admittance

STATIC CHARACTERISTICS

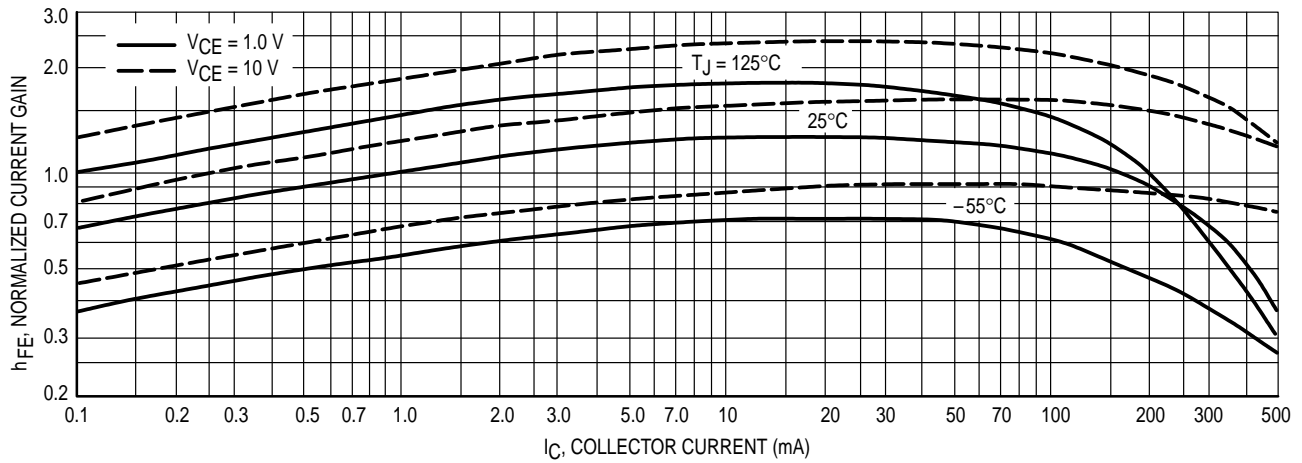

Figure 14. DC Current Gain

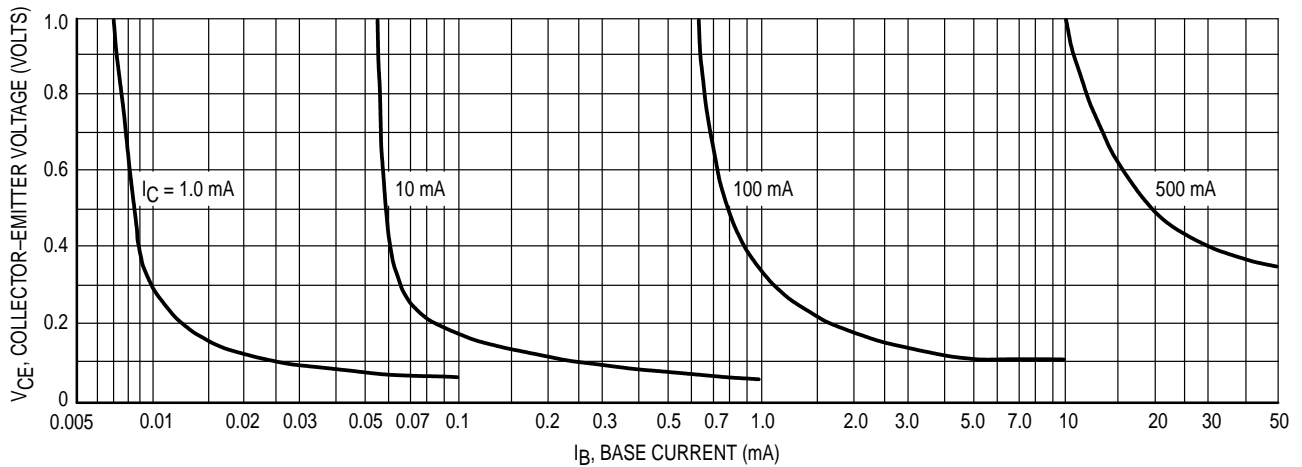

Figure 15. Collector Saturation Region

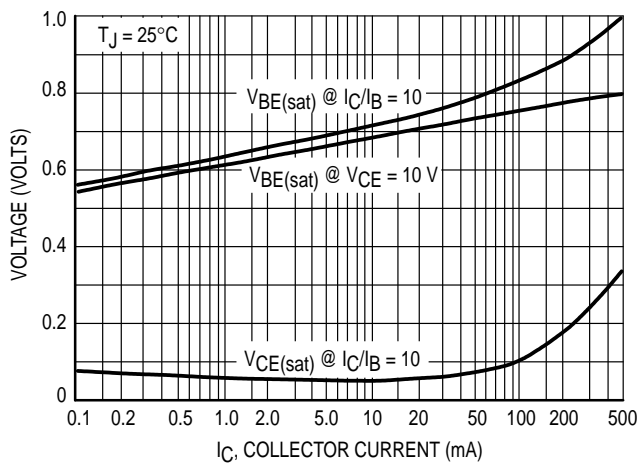

Figure 16. "On" Voltages

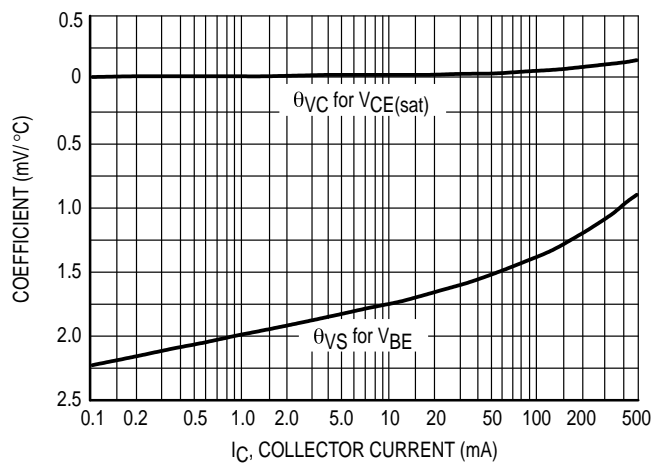
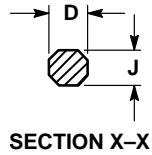
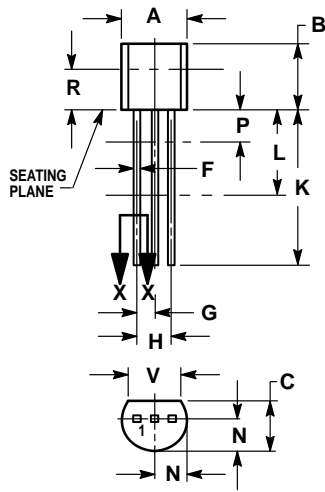

Figure 17. Temperature Coefficients

PACKAGE DIMENSIONS



CASE 029-04
(TO-226AA)
ISSUE AD

- NOTES:
1. DIMENSIONING AND TOLERANCING PER ANSI Y14.5M, 1982.
 2. CONTROLLING DIMENSION: INCH.
 3. CONTOUR OF PACKAGE BEYOND DIMENSION R IS UNCONTROLLED.
 4. DIMENSION F APPLIES BETWEEN P AND L. DIMENSION D AND J APPLY BETWEEN L AND K. MINIMUM LEAD DIMENSION IS UNCONTROLLED IN P AND BEYOND DIMENSION K MINIMUM.

DIM	INCHES		MILLIMETERS	
	MIN	MAX	MIN	MAX
A	0.175	0.205	4.45	5.20
B	0.170	0.210	4.32	5.33
C	0.125	0.165	3.18	4.19
D	0.016	0.022	0.41	0.55
F	0.016	0.019	0.41	0.48
G	0.045	0.055	1.15	1.39
H	0.095	0.105	2.42	2.66
J	0.015	0.020	0.39	0.50
K	0.500	—	12.70	—
L	0.250	—	6.35	—
N	0.080	0.105	2.04	2.66
P	—	0.100	—	2.54
R	0.115	—	2.93	—
V	0.135	—	3.43	—

- STYLE 1:
PIN 1. EMITTER
2. BASE
3. COLLECTOR

Motorola reserves the right to make changes without further notice to any products herein. Motorola makes no warranty, representation or guarantee regarding the suitability of its products for any particular purpose, nor does Motorola assume any liability arising out of the application or use of any product or circuit, and specifically disclaims any and all liability, including without limitation consequential or incidental damages. "Typical" parameters can and do vary in different applications. All operating parameters, including "Typicals" must be validated for each customer application by customer's technical experts. Motorola does not convey any license under its patent rights nor the rights of others. Motorola products are not designed, intended, or authorized for use as components in systems intended for surgical implant into the body, or other applications intended to support or sustain life, or for any other application in which the failure of the Motorola product could create a situation where personal injury or death may occur. Should Buyer purchase or use Motorola products for any such unintended or unauthorized application, Buyer shall indemnify and hold Motorola and its officers, employees, subsidiaries, affiliates, and distributors harmless against all claims, costs, damages, and expenses, and reasonable attorney fees arising out of, directly or indirectly, any claim of personal injury or death associated with such unintended or unauthorized use, even if such claim alleges that Motorola was negligent regarding the design or manufacture of the part. Motorola and  are registered trademarks of Motorola, Inc. Motorola, Inc. is an Equal Opportunity/Affirmative Action Employer.

How to reach us:

USA/EUROPE: Motorola Literature Distribution;
P.O. Box 20912; Phoenix, Arizona 85036. 1-800-441-2447

JAPAN: Nippon Motorola Ltd.; Tatsumi-SPD-JLDC, Toshikatsu Otsuki,
6F Seibu-Butsuryu-Center, 3-14-2 Tatsumi Koto-Ku, Tokyo 135, Japan. 03-3521-8315

MFAX: RMFAX0@email.sps.mot.com – TOUCHTONE (602) 244-6609
INTERNET: <http://Design-NET.com>

HONG KONG: Motorola Semiconductors H.K. Ltd.; 8B Tai Ping Industrial Park,
51 Ting Kok Road, Tai Po, N.T., Hong Kong. 852-26629298

