

Amplifier Transistor

PNP Silicon

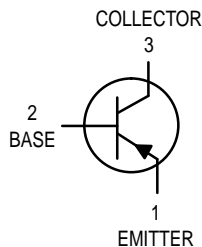

MP5L51

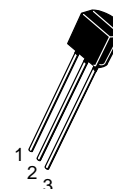

CASE 29-04, STYLE 1
TO-92 (TO-226AA)

MAXIMUM RATINGS

Rating	Symbol	Value	Unit
Collector–Emitter Voltage	V_{CEO}	-100	Vdc
Collector–Base Voltage	V_{CBO}	-100	Vdc
Emitter–Base Voltage	V_{EBO}	-4.0	Vdc
Collector Current — Continuous	I_C	-600	mAdc
Total Device Dissipation @ $T_A = 25^\circ\text{C}$ Derate above 25°C	P_D	625 5.0	mW mW/ $^\circ\text{C}$
Total Device Dissipation @ $T_C = 25^\circ\text{C}$ Derate above 25°C	P_D	1.5 12	Watts mW/ $^\circ\text{C}$
Operating and Storage Junction Temperature Range	T_J, T_{stg}	-55 to +150	$^\circ\text{C}$

THERMAL CHARACTERISTICS

Characteristic	Symbol	Max	Unit
Thermal Resistance, Junction to Ambient	$R_{\theta JA}$	200	$^\circ\text{C}/\text{W}$
Thermal Resistance, Junction to Case	$R_{\theta JC}$	83.3	$^\circ\text{C}/\text{W}$

ELECTRICAL CHARACTERISTICS ($T_A = 25^\circ\text{C}$ unless otherwise noted)

Characteristic	Symbol	Min	Max	Unit
----------------	--------	-----	-----	------

OFF CHARACTERISTICS

Collector–Emitter Breakdown Voltage ⁽¹⁾ ($I_C = -1.0$ mAdc, $I_E = 0$)	$V_{(BR)CEO}$	-100	—	Vdc
Collector–Base Breakdown Voltage ($I_C = -100$ μAdc , $I_E = 0$)	$V_{(BR)CBO}$	-100	—	Vdc
Emitter–Base Breakdown Voltage ($I_E = -10$ μAdc , $I_C = 0$)	$V_{(BR)EBO}$	-4.0	—	Vdc
Collector Cutoff Current ($V_{CB} = -50$ Vdc, $I_E = 0$)	I_{CBO}	—	-1.0	μAdc
Emitter Cutoff Current ($V_{EB} = -3.0$ Vdc, $I_C = 0$)	I_{EBO}	—	-100	nAdc

1. Pulse Test: Pulse Width = 300 μs , Duty Cycle = 2.0%.

MPSL51**ELECTRICAL CHARACTERISTICS** ($T_A = 25^\circ\text{C}$ unless otherwise noted) (Continued)

Characteristic	Symbol	Min	Max	Unit
ON CHARACTERISTICS(1)				
DC Current Gain ⁽¹⁾ ($I_C = -50\text{ mA dc}$, $V_{CE} = -5.0\text{ V dc}$)	h_{FE}	40	250	—
Collector–Emitter Saturation Voltage ($I_C = -10\text{ mA dc}$, $I_B = -1.0\text{ mA dc}$) ($I_C = -50\text{ mA dc}$, $I_B = -5.0\text{ mA dc}$)	$V_{CE(sat)}$	— —	-0.25 -0.30	Vdc
Base–Emitter Saturation Voltage ($I_C = -10\text{ mA dc}$, $I_B = -1.0\text{ mA dc}$) ($I_C = -50\text{ mA dc}$, $I_B = -5.0\text{ mA dc}$)	$V_{BE(sat)}$	— —	-1.2 -1.2	Vdc

SMALL–SIGNAL CHARACTERISTICS

Current–Gain — Bandwidth Product ($I_C = -10\text{ mA dc}$, $V_{CE} = -10\text{ V dc}$, $f = 20\text{ MHz}$)	f_T	60	—	MHz
Output Capacitance ($V_{CB} = -10\text{ V dc}$, $I_E = 0$, $f = 1.0\text{ MHz}$)	C_{obo}	—	8.0	pF
Small–Signal Current Gain ($I_C = -1.0\text{ mA dc}$, $V_{CE} = -10\text{ V dc}$, $f = 1.0\text{ kHz}$)	h_{fe}	20	—	—

1. Pulse Test: Pulse Width = 300 μs , Duty Cycle = 2.0%.

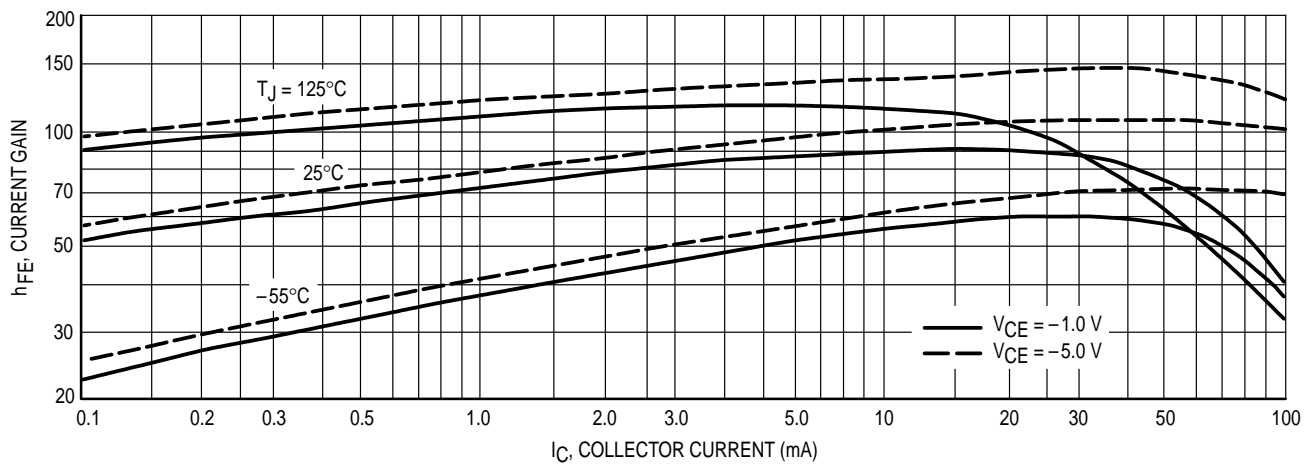

Figure 1. DC Current Gain

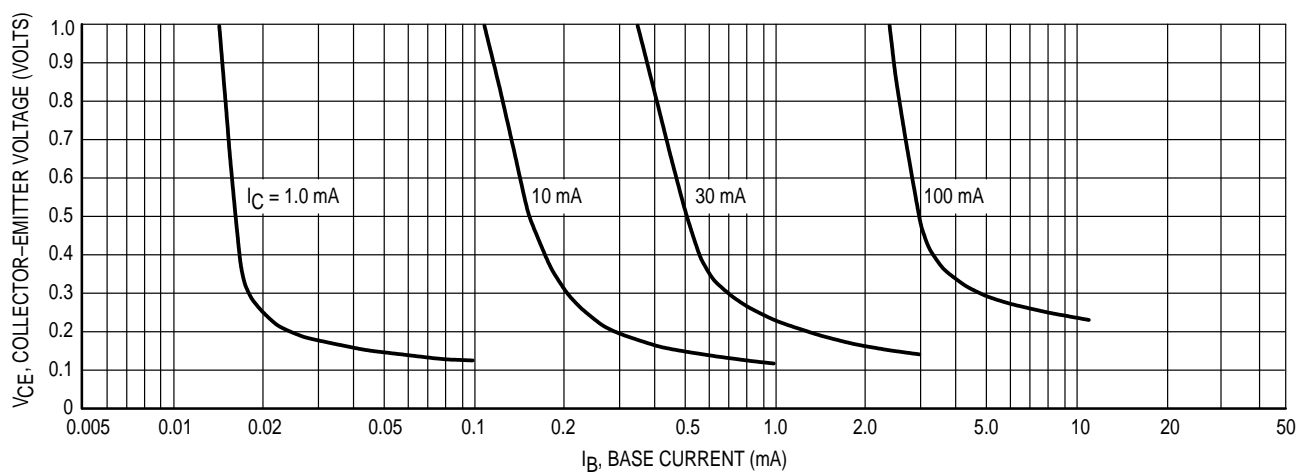

Figure 2. Collector Saturation Region

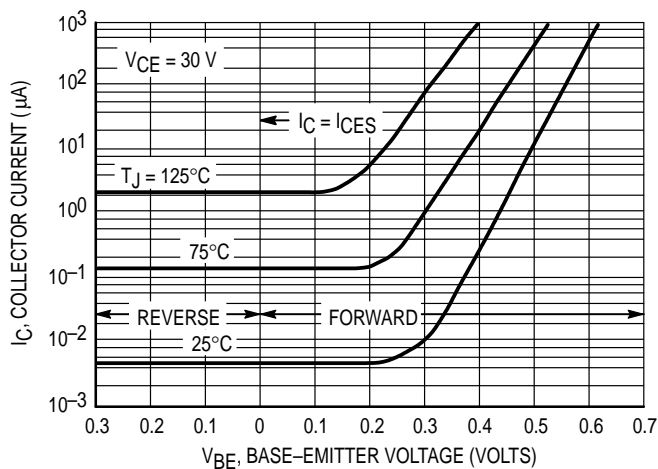

Figure 3. Collector Cut-Off Region

MPSL51

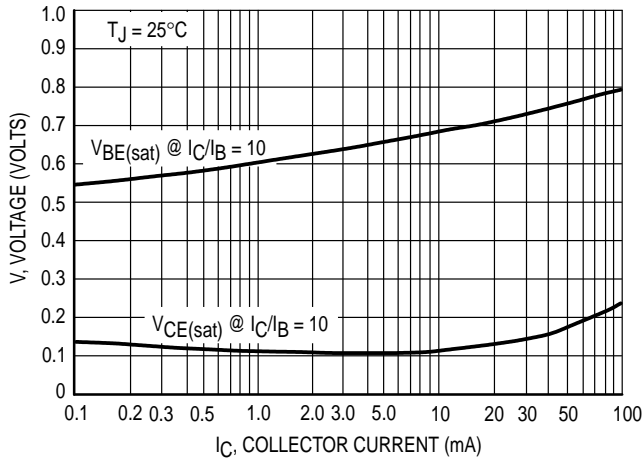

Figure 4. "On" Voltages

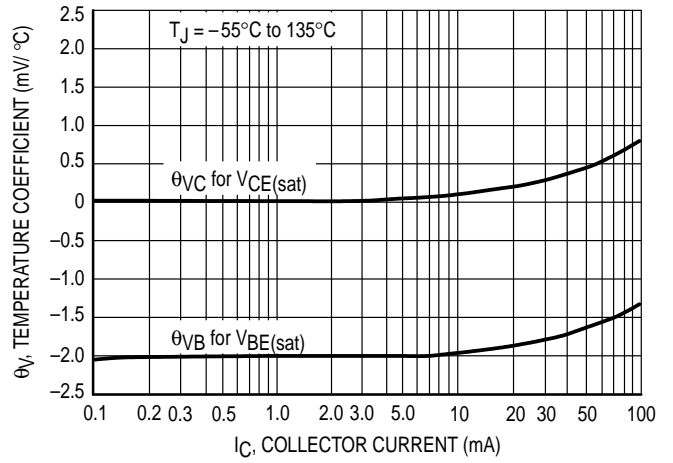

Figure 5. Temperature Coefficients

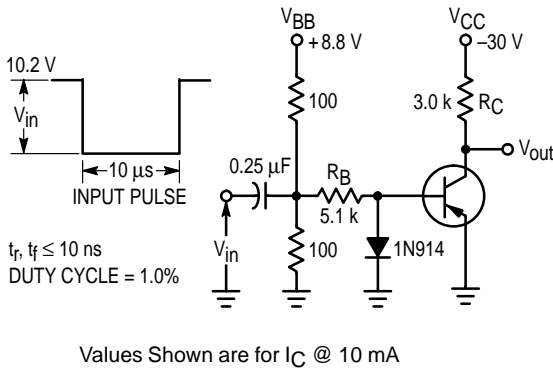

Figure 6. Switching Time Test Circuit

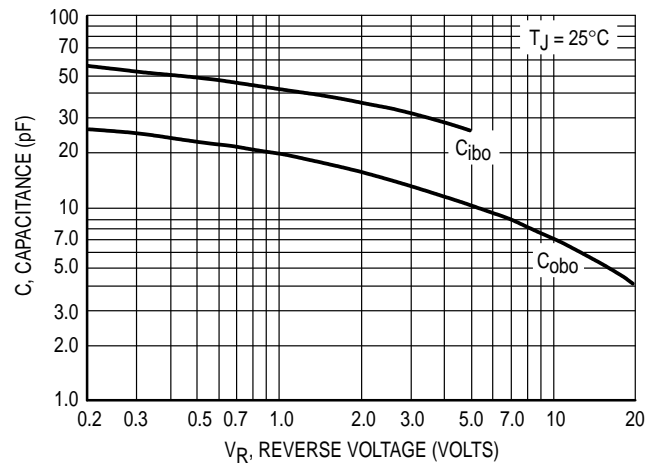

Figure 7. Capacitances

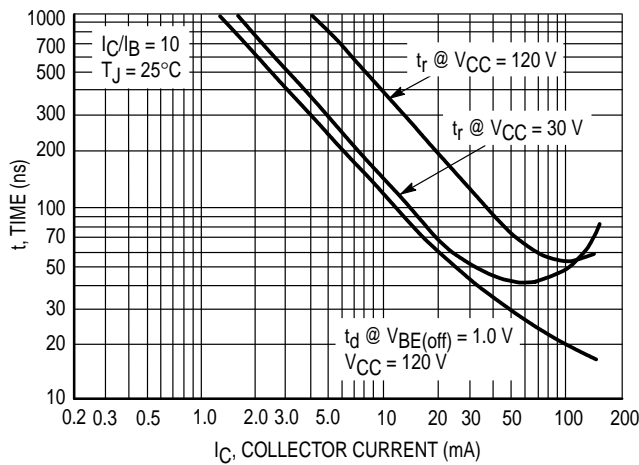

Figure 8. Turn-On Time

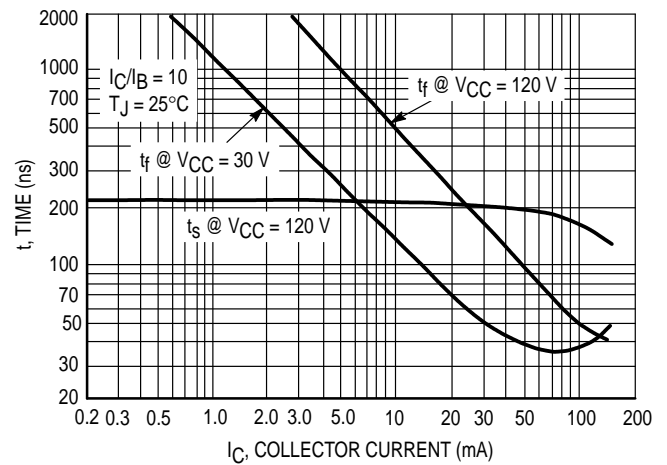
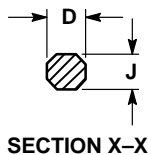
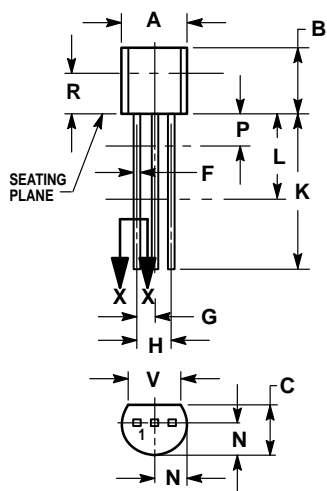

Figure 9. Turn-Off Time

PACKAGE DIMENSIONS



**CASE 029-04
(TO-226AA)
ISSUE AD**

- NOTES:
1. DIMENSIONING AND TOLERANCING PER ANSI Y14.5M, 1982.
 2. CONTROLLING DIMENSION: INCH.
 3. CONTOUR OF PACKAGE BEYOND DIMENSION R IS UNCONTROLLED.
 4. DIMENSION F APPLIES BETWEEN P AND L. DIMENSION D AND J APPLY BETWEEN L AND K. MINIMUM LEAD DIMENSION IS UNCONTROLLED IN P AND BEYOND DIMENSION K MINIMUM.

DIM	INCHES		MILLIMETERS	
	MIN	MAX	MIN	MAX
A	0.175	0.205	4.45	5.20
B	0.170	0.210	4.32	5.33
C	0.125	0.165	3.18	4.19
D	0.016	0.022	0.41	0.55
F	0.016	0.019	0.41	0.48
G	0.045	0.055	1.15	1.39
H	0.095	0.105	2.42	2.66
J	0.015	0.020	0.39	0.50
K	0.500	—	12.70	—
L	0.250	—	6.35	—
N	0.080	0.105	2.04	2.66
P	—	0.100	—	2.54
R	0.115	—	2.93	—
V	0.135	—	3.43	—

- STYLE 1:
1. EMITTER
 2. BASE
 3. COLLECTOR

Motorola reserves the right to make changes without further notice to any products herein. Motorola makes no warranty, representation or guarantee regarding the suitability of its products for any particular purpose, nor does Motorola assume any liability arising out of the application or use of any product or circuit, and specifically disclaims any and all liability, including without limitation consequential or incidental damages. "Typical" parameters which may be provided in Motorola data sheets and/or specifications can and do vary in different applications and actual performance may vary over time. All operating parameters, including "Typicals" must be validated for each customer application by customer's technical experts. Motorola does not convey any license under its patent rights nor the rights of others. Motorola products are not designed, intended, or authorized for use as components in systems intended for surgical implant into the body, or other applications intended to support or sustain life, or for any other application in which the failure of the Motorola product could create a situation where personal injury or death may occur. Should Buyer purchase or use Motorola products for any such unintended or unauthorized application, Buyer shall indemnify and hold Motorola and its officers, employees, subsidiaries, affiliates, and distributors harmless against all claims, costs, damages, and expenses, and reasonable attorney fees arising out of, directly or indirectly, any claim of personal injury or death associated with such unintended or unauthorized use, even if such claim alleges that Motorola was negligent regarding the design or manufacture of the part. Motorola and  are registered trademarks of Motorola, Inc. Motorola, Inc. is an Equal Opportunity/Affirmative Action Employer.

How to reach us:

USA/EUROPE/Locations Not Listed: Motorola Literature Distribution;
P.O. Box 20912; Phoenix, Arizona 85036. 1-800-441-2447 or 602-303-5454

JAPAN: Nippon Motorola Ltd.; Tatsumi-SPD-JLDC, 6F Seibu-Butsuryu-Center,
3-14-2 Tatsumi Koto-Ku, Tokyo 135, Japan. 03-81-3521-8315

MFAX: RMFAX0@email.sps.mot.com – TOUCHTONE 602-244-6609
INTERNET: <http://Design-NET.com>

ASIA/PACIFIC: Motorola Semiconductors H.K. Ltd.; 8B Tai Ping Industrial Park,
51 Ting Kok Road, Tai Po, N.T., Hong Kong. 852-26629298

