

Designer's™ Data Sheet

Power Field Effect Transistor
P-Channel Enhancement-Mode Silicon Gate

MTP23P06

Motorola Preferred Device

This TMOS Power FET is designed for high speed power switching applications such as switching regulators, converters, solenoid and relay drivers.

- Silicon Gate for Fast Switching Speeds — Switching Times Specified at 100°C
- Designer's Data — I_{DSS} , $V_{DS(on)}$, $V_{GS(th)}$ and SOA Specified at Elevated Temperature
- Rugged — SOA is Power Dissipation Limited
- Source-to-Drain Diode Characterized for Use With Inductive Loads
- Ultra Low $r_{DS(on)}$ P-Channel Series



TMOS POWER FET
23 AMPERES
 $r_{DS(on)} = 0.12 \text{ OHM}$
60 VOLTS

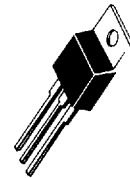
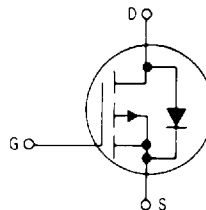

CASE 221A-06
TO-220AB

MAXIMUM RATINGS

Rating	Symbol	Value	Unit
Drain-to-Source Voltage	V_{DSS}	60	Vdc
Drain-Gate Voltage ($R_{GS} = 1.0 \text{ M}\Omega$)	V_{DGR}	60	Vdc
Gate-Source Voltage — Continuous — Non-Repetitive ($t_p \leq 50 \mu s$)	V_{GS} V_{GSM}	± 15 ± 20	Vdc
Drain Current — Continuous — Pulsed	I_D I_{DM}	23 75	Adc
Total Power Dissipation Derate above 25°C	P_D	125 0.8	Watts W/°C
Operating and Storage Temperature Range	T_J, T_{stg}	-55 to 150	°C

THERMAL CHARACTERISTICS

Thermal Resistance — Junction to Case — Junction to Ambient	$R_{\theta JC}$ $R_{\theta JA}$	1.0 62.5	°C/W
Maximum Lead Temperature for Soldering Purposes, 1/8" from case for 10 seconds	T_L	260	°C

ELECTRICAL CHARACTERISTICS ($T_J = 25^\circ\text{C}$ unless otherwise noted)

Characteristic	Symbol	Min	Max	Unit
Drain-Source Breakdown Voltage ($V_{GS} = 0, I_D = 0.25 \text{ mA}$)	$V_{(BR)DSS}$	60	—	Vdc
Zero Gate Voltage Drain Current ($V_{DS} = \text{Rated } V_{DSS}, V_{GS} = 0$) ($V_{DS} = \text{Rated } V_{DSS}, V_{GS} = 0, T_J = 125^\circ\text{C}$)	I_{DSS}	— —	0.1 1.0	mAdc
Gate-Body Leakage Current, Forward ($V_{GSF} = 15 \text{ Vdc}, V_{DS} = 0$)	I_{GSSF}	—	100	nAdc
Gate-Body Leakage Current, Reverse ($V_{GSR} = 15 \text{ Vdc}, V_{DS} = 0$)	I_{GSSR}	—	100	nAdc

(continued)

Designer's Data for "Worst Case" Conditions — The Designer's Data Sheet permits the design of most circuits entirely from the information presented. Limit curves — representing boundaries on device characteristics — are given to facilitate "worst case" design.

Designer's is a trademark of Motorola, Inc. TMOS is a registered trademark of Motorola, Inc.

Preferred devices are Motorola recommended choices for future use and best overall value.

REV 1

■ 6367254 0102888 62T ■

ELECTRICAL CHARACTERISTICS — continued ($T_J = 25^\circ\text{C}$ unless otherwise noted)

Characteristic	Symbol	Min	Max	Unit
----------------	--------	-----	-----	------

ON CHARACTERISTICS*

Gate Threshold Voltage ($V_{DS} = V_{GS}$, $I_D = 1.0\text{ mA}$) ($T_J = 100^\circ\text{C}$)	$V_{GS(th)}$	2.0 1.5	4.5 4.0	Vdc
Static Drain-to-Source On-Resistance ($V_{GS} = 10\text{ Vdc}$, $I_D = 11.5\text{ Adc}$)	$r_{DS(on)}$	—	0.12	Ohm
Drain-to-Source On-Voltage ($V_{GS} = 10\text{ V}$) ($I_D = 23\text{ Adc}$) ($I_D = 11.5\text{ Adc}$, $T_J = 100^\circ\text{C}$)	$V_{DS(on)}$	— —	3.3 3.0	Vdc
Forward Transconductance ($V_{DS} = 15\text{ V}$, $I_D = 11.5\text{ A}$)	g_{FS}	5.0	—	mhos

DYNAMIC CHARACTERISTICS

Input Capacitance	($V_{DS} = 25\text{ V}$, $V_{GS} = 0$, $f = 1.0\text{ MHz}$) See Figure 11	C_{iss}	—	1700	pF
Output Capacitance		C_{oss}	—	900	
Reverse Transfer Capacitance		C_{rss}	—	400	

SWITCHING CHARACTERISTICS*

Turn-On Delay Time	($V_{DD} = 25\text{ V}$, $I_D = 23\text{ Amp}$, $R_{gen} = 13\text{ Ohms}$) See Figures 9, 13 and 14	$t_{d(on)}$	—	30	ns
Rise Time		t_r	—	170	
Turn-Off Delay Time		$t_{d(off)}$	—	140	
Fall Time		t_f	—	120	
Total Gate Charge	($V_{DS} = 0.8\text{ Rated }V_{DSS}$, $I_D = 23\text{ Amp}$, $V_{GS} = 10\text{ V}$) See Figure 12	Q_g	80 (Typ)	120	nC
Gate-Source Charge		Q_{gs}	10 (Typ)	—	
Gate-Drain Charge		Q_{gd}	30 (Typ)	—	

SOURCE-DRAIN DIODE CHARACTERISTICS*

Forward On-Voltage	($I_S = 23\text{ Amp}$, $V_{GS} = 0$)	V_{SD}	2.2 (Typ)	3.5	Vdc
Forward Turn-On Time		t_{on}	100 (Typ)	—	ns
Reverse Recovery Time		t_{rr}	120 (Typ)	—	

INTERNAL PACKAGE INDUCTANCE (TO-220)

Internal Drain Inductance (Measured from the contact screw on tab to center of die) (Measured from the drain lead 0.25" from package to center of die)	L_d	3.5 (Typ) 4.5 (Typ)	— —	nH
Internal Source Inductance (Measured from the source lead 0.25" from package to center of pad)	L_s	7.5 (Typ)	—	

*Pulse Test: Pulse Width $\leq 300\ \mu\text{s}$, Duty Cycle $\leq 2.0\%$.

TYPICAL ELECTRICAL CHARACTERISTICS

Figure 1. On-Region Characteristics

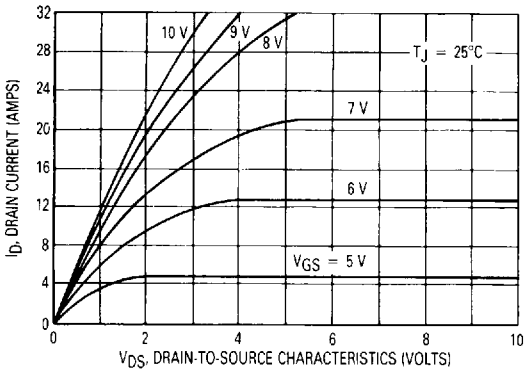

Figure 2. Gate-Threshold Variation With Temperature

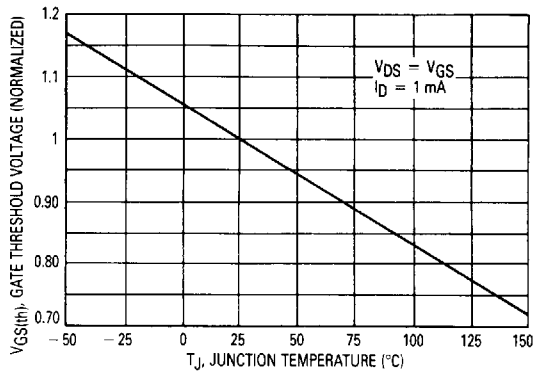

Figure 3. Transfer Characteristics

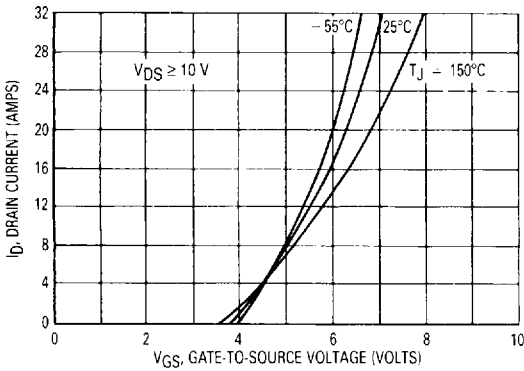
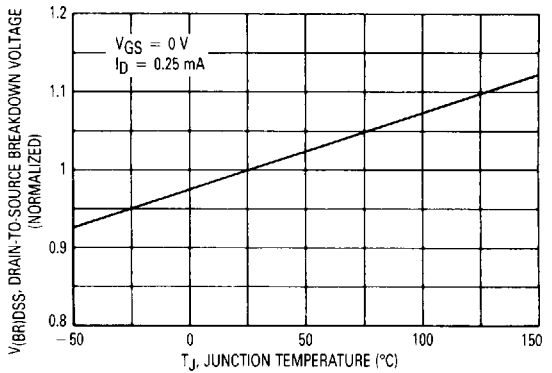

Figure 4. Normalized Breakdown Voltage versus Temperature



8

Figure 5. On-Resistance versus Drain Current

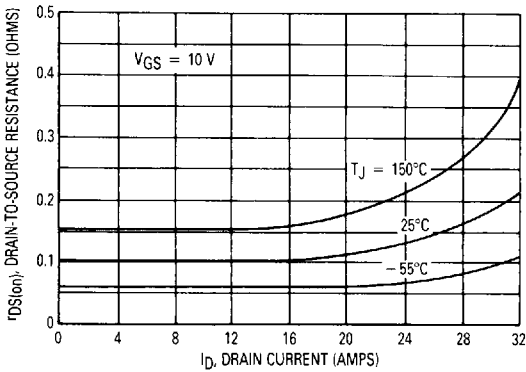
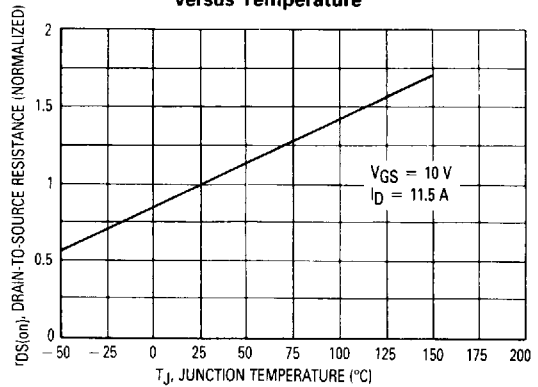

Figure 6. Normalized On-Resistance versus Temperature



SAFE OPERATING AREA INFORMATION

Figure 7. Maximum Rated Forward Biased Safe Operating Area

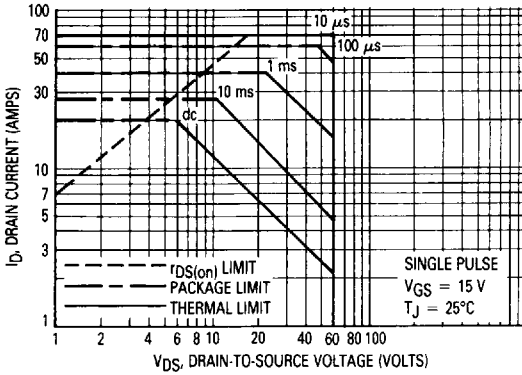
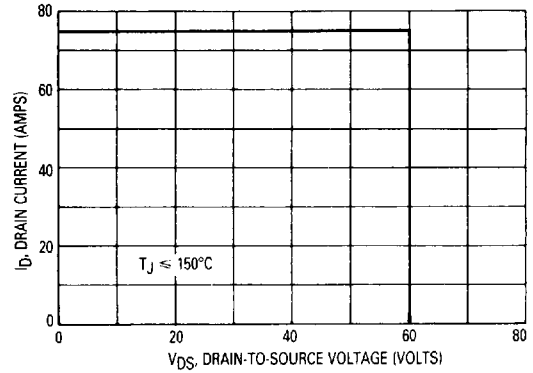

Figure 8. Maximum Rated Switching Safe Operating Area



FORWARD BIASED SAFE OPERATING AREA

The FBSOA curves define the maximum drain-to-source voltage and drain current that a device can safely handle when it is forward biased, or when it is on, or being turned on. Because these curves include the limitations of simultaneous high voltage and high current, up to the rating of the device, they are especially useful to designers of linear systems. The curves are based on a case temperature of 25°C and a maximum junction temperature of 150°C. Limitations for repetitive pulses at various case temperatures can be determined by using the thermal response curves. Motorola Application Note, AN569, "Transient Thermal Resistance-General Data and Its Use" provides detailed instructions.

SWITCHING SAFE OPERATING AREA

The switching safe operating area (SOA) of Figure 8 is the boundary that the load line may traverse without incurring damage to the MOSFET. The fundamental limits are the peak current, I_{DM} and the breakdown voltage, $V_{(BR)DSS}$. The switching SOA shown in Figure 8 is applicable for both turn-on and turn-off of the devices for switching times less than one microsecond.

The power averaged over a complete switching cycle must be less than:

$$\frac{T_{J(max)} - T_C}{R_{\theta JC}}$$

Figure 9. Resistive Switching Time Variation versus Gate Resistance

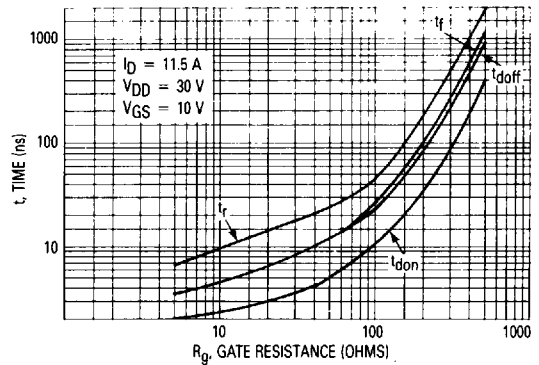

Figure 10. Thermal Response

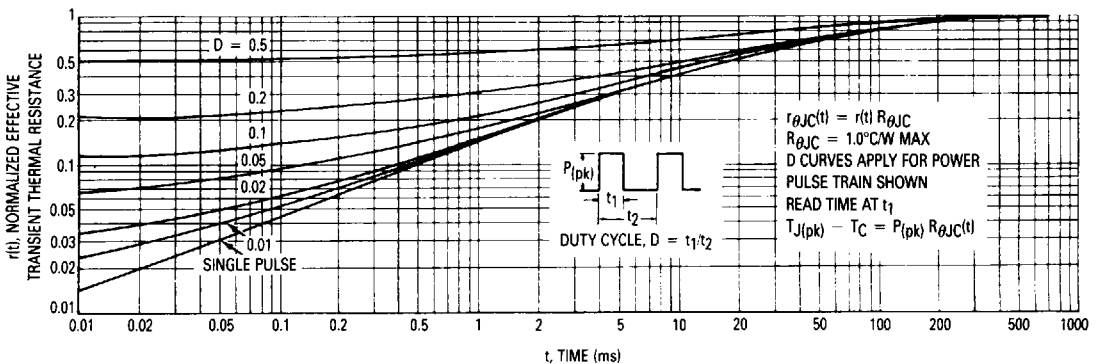

Figure 11. Capacitance Variation

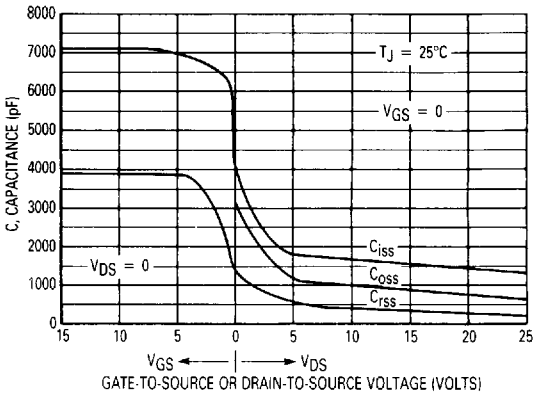
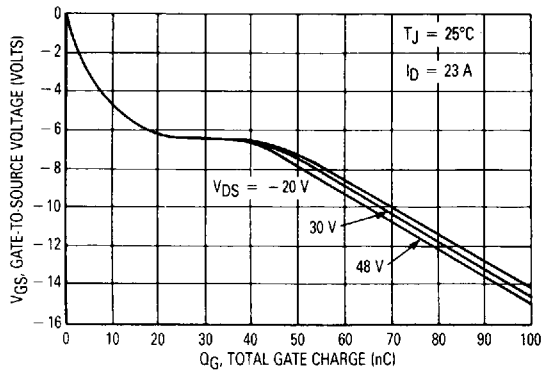

Figure 12. Gate Charge versus Gate-To-Source Voltage



RESISTIVE SWITCHING

Figure 13. Switching Test Circuit

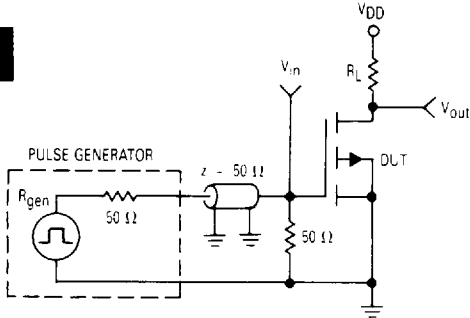
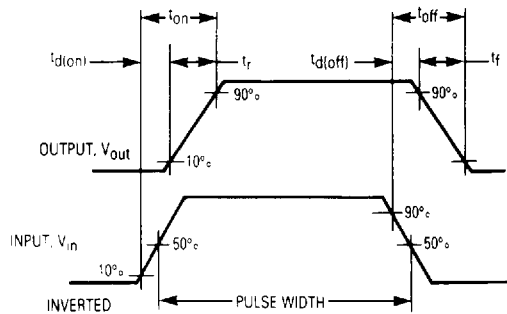

Figure 14. Switching Waveforms



TMOS SOURCE-TO-DRAIN DIODE CHARACTERISTICS

In the fabrication of a TMOS FET, a diode is formed across the source-to-drain terminals as shown in Figure 15. Reversal of the drain voltage will cause current flow in the reverse direction. This diode may be used in circuits

requiring external fast recovery diodes, therefore, typical characteristics of the on voltage, forward turn-on and reverse recovery times are given.

Figure 15. TMOS FET With Source-To-Drain Diode

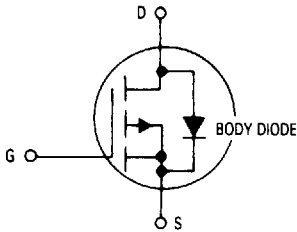

Figure 16. Diode Switching Waveform

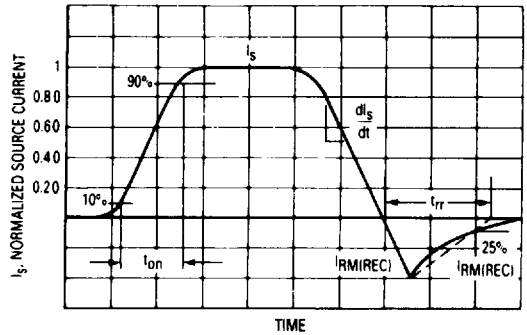

Figure 17. TMOS Diode Switching Test Circuit

NOTE: DUT is Shown as an N-Channel TMOS but can also be a P-Channel when appropriately connected. DUT Driver is the same device as DUT Diode (or Complement for P-Channel DUT Diode)

