

# SWITCHMODE™ Power Rectifiers

## Ultrafast “E” Series with High Reverse Energy Capability

... designed for use in switching power supplies, inverters and as free wheeling diodes, these state-of-the-art devices have the following features:

- 20 mJoules Avalanche Energy Guaranteed
- Excellent Protection Against Voltage Transients in Switching Inductive Load Circuits
- Ultrafast 75 Nanosecond Recovery Time
- 175°C Operating Junction Temperature
- Low Forward Voltage
- Low Leakage Current
- High Temperature Glass Passivated Junction
- Reverse Voltage to 1000 Volts

### Mechanical Characteristics:

- Case: Epoxy, Molded
- Weight: 0.4 gram (approximately)
- Finish: All External Surfaces Corrosion Resistant and Terminal Leads are Readily Solderable
- Lead and Mounting Surface Temperature for Soldering Purposes: 220°C Max. for 10 Seconds, 1/16" from case
- Shipped in plastic bags, 1000 per bag
- Available Tape and Reeled, 5000 per reel, by adding a "RL" suffix to the part number
- Polarity: Cathode Indicated by Polarity Band
- Marking: U190E, U1100E

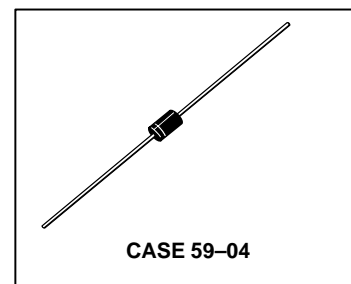

### MAXIMUM RATINGS

Rating	Symbol	MUR		Unit
		190E	1100E	
Peak Repetitive Reverse Voltage Working Peak Reverse Voltage DC Blocking Voltage	$V_{RRM}$ $V_{RWM}$ $V_R$	900	1000	Volts
Average Rectified Forward Current (Square Wave) (Mounting Method #3 Per Note 1)	$I_{F(AV)}$	1.0 @ $T_A = 95^\circ\text{C}$		Amps
Nonrepetitive Peak Surge Current (Surge applied at rated load conditions, halfwave, single phase, 60 Hz)	$I_{FSM}$	35		Amps
Operating Junction Temperature and Storage Temperature	$T_J, T_{stg}$	-65 to +175		°C

### THERMAL CHARACTERISTICS

Maximum Thermal Resistance, Junction to Ambient	$R_{\theta JA}$	See Note 1	°C/W
---	-----------------	------------	------

(1) Pulse Test: Pulse Width = 300  $\mu\text{s}$ , Duty Cycle  $\leq 2.0\%$ .

SWITCHMODE is a trademark of Motorola, Inc.

Preferred devices are Motorola recommended choices for future use and best overall value.

Rev 1

**MUR190E MUR1100E****ELECTRICAL CHARACTERISTICS**

Rating	Symbol	MUR		Unit
		190E	1100E	
Maximum Instantaneous Forward Voltage (1) ( $i_F = 1.0$ Amp, $T_J = 150^\circ\text{C}$ ) ( $i_F = 1.0$ Amp, $T_J = 25^\circ\text{C}$ )	$v_F$	1.50 1.75		Volts
Maximum Instantaneous Reverse Current (1) (Rated dc Voltage, $T_J = 100^\circ\text{C}$ ) (Rated dc Voltage, $T_J = 25^\circ\text{C}$ )	$i_R$	600 10		$\mu\text{A}$
Maximum Reverse Recovery Time ( $I_F = 1.0$ Amp, $di/dt = 50$ Amp/ $\mu\text{s}$ ) ( $I_F = 0.5$ Amp, $i_R = 1.0$ Amp, $I_{REC} = 0.25$ Amp)	$t_{rr}$	100 75		ns
Maximum Forward Recovery Time ( $I_F = 1.0$ Amp, $di/dt = 100$ Amp/ $\mu\text{s}$ , Recovery to 1.0 V)	$t_{fr}$	75		ns
Controlled Avalanche Energy (See Test Circuit in Figure 6)	$W_{AVAIL}$	10		mJ

(1) Pulse Test: Pulse Width = 300  $\mu\text{s}$ , Duty Cycle  $\leq 2.0\%$ .

ELECTRICAL CHARACTERISTICS

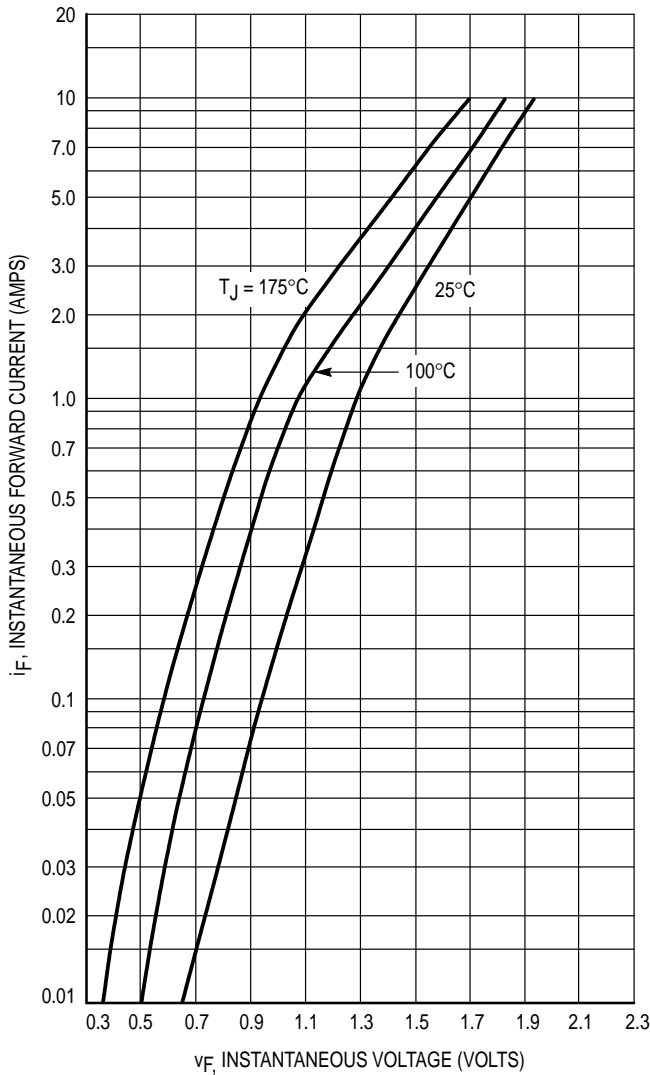

Figure 1. Typical Forward Voltage

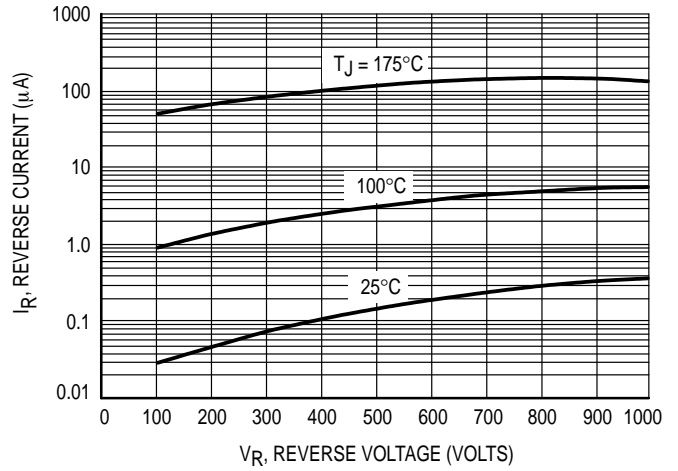

Figure 2. Typical Reverse Current\*

\* The curves shown are typical for the highest voltage device in the grouping. Typical reverse current for lower voltage selections can be estimated from these same curves if  $V_R$  is sufficiently below rated  $V_R$ .

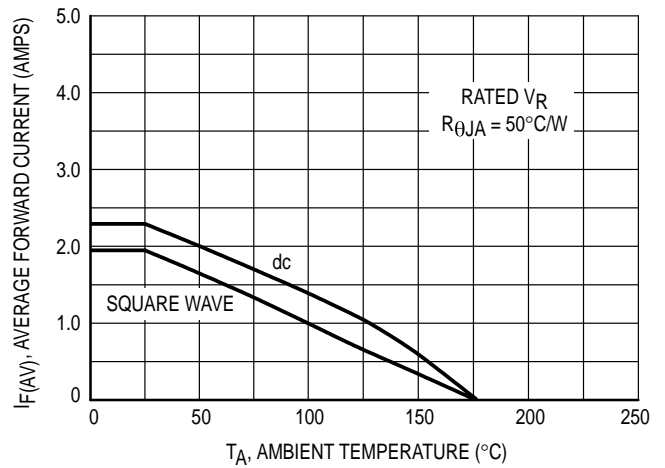

Figure 3. Current Derating  
(Mounting Method #3 Per Note 1)

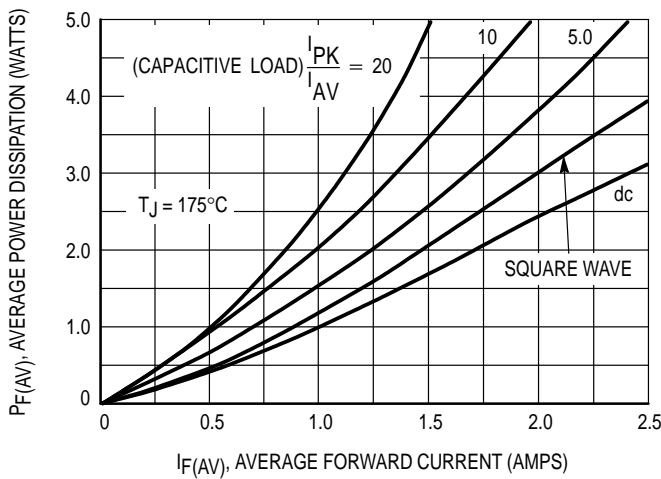

Figure 4. Power Dissipation

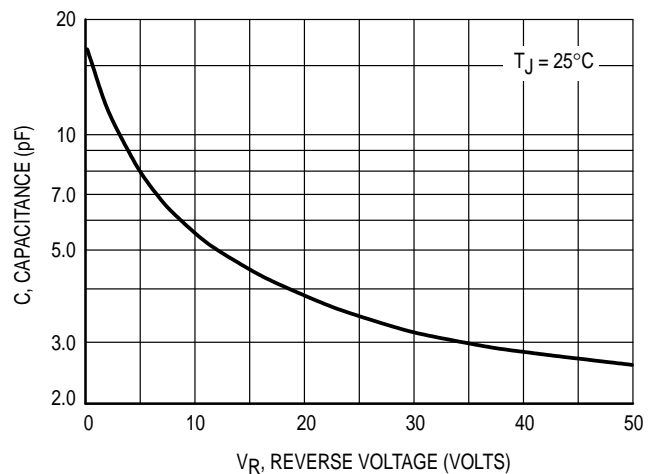

Figure 5. Typical Capacitance

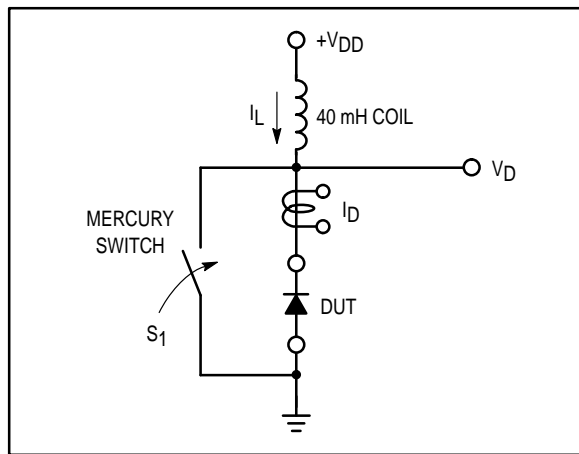

Figure 6. Test Circuit

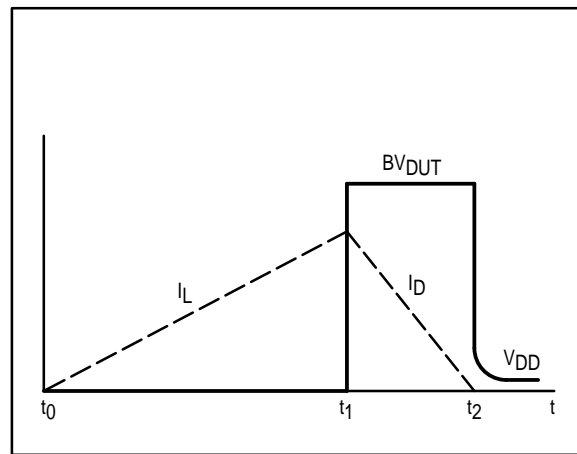

Figure 7. Current–Voltage Waveforms

The unclamped inductive switching circuit shown in Figure 6 was used to demonstrate the controlled avalanche capability of the new “E” series Ultrafast rectifiers. A mercury switch was used instead of an electronic switch to simulate a noisy environment when the switch was being opened.

When S<sub>1</sub> is closed at t<sub>0</sub> the current in the inductor I<sub>L</sub> ramps up linearly; and energy is stored in the coil. At t<sub>1</sub> the switch is opened and the voltage across the diode under test begins to rise rapidly, due to di/dt effects, when this induced voltage reaches the breakdown voltage of the diode, it is clamped at BV<sub>DUT</sub> and the diode begins to conduct the full load current which now starts to decay linearly through the diode, and goes to zero at t<sub>2</sub>.

By solving the loop equation at the point in time when S<sub>1</sub> is opened; and calculating the energy that is transferred to the diode it can be shown that the total energy transferred is equal to the energy stored in the inductor plus a finite amount of energy from the V<sub>DD</sub> power supply while the diode is in breakdown (from t<sub>1</sub> to t<sub>2</sub>) minus any losses due to finite com-

ponent resistances. Assuming the component resistive elements are small Equation (1) approximates the total energy transferred to the diode. It can be seen from this equation that if the V<sub>DD</sub> voltage is low compared to the breakdown voltage of the device, the amount of energy contributed by the supply during breakdown is small and the total energy can be assumed to be nearly equal to the energy stored in the coil during the time when S<sub>1</sub> was closed, Equation (2).

The oscilloscope picture in Figure 8, shows the information obtained for the MUR8100E (similar die construction as the MUR1100E Series) in this test circuit conducting a peak current of one ampere at a breakdown voltage of 1300 volts, and using Equation (2) the energy absorbed by the MUR8100E is approximately 20 mjoules.

Although it is not recommended to design for this condition, the new “E” series provides added protection against those unforeseen transient viruses that can produce unexplained random failures in unfriendly environments.

EQUATION (1):

$$W_{\text{AVAL}} \approx \frac{1}{2} L I_{\text{LPK}}^2 \left( \frac{BV_{\text{DUT}}}{BV_{\text{DUT}} - V_{\text{DD}}} \right)$$

EQUATION (2):

$$W_{\text{AVAL}} \approx \frac{1}{2} L I_{\text{LPK}}^2$$

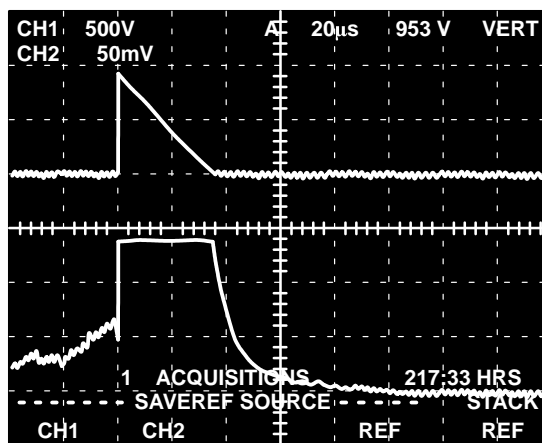

CHANNEL 2:

I<sub>L</sub>  
0.5 AMPS/DIV.

CHANNEL 1:

V<sub>DUT</sub>  
500 VOLTS/DIV.

TIME BASE:

20 μs/DIV.

Figure 8. Current–Voltage Waveforms

**NOTE 1 — AMBIENT MOUNTING DATA**

Data shown for thermal resistance junction to ambient ( $R_{\theta JA}$ ) for the mountings shown is to be used as typical guideline values for preliminary engineering or in case the tie point temperature cannot be measured.

**TYPICAL VALUES FOR  $R_{\theta JA}$  IN STILL AIR**

Mounting Method	$R_{\theta JA}$	Lead Length, L			Units
		1/8	1/4	1/2	
1		52	65	72	$^{\circ}\text{C}/\text{W}$
2		67	80	87	$^{\circ}\text{C}/\text{W}$
3		50			$^{\circ}\text{C}/\text{W}$

**MOUNTING METHOD 1**

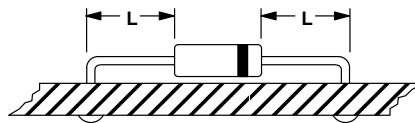

**MOUNTING METHOD 2**

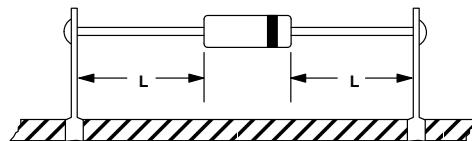

**Vector Pin Mounting**

**MOUNTING METHOD 3**

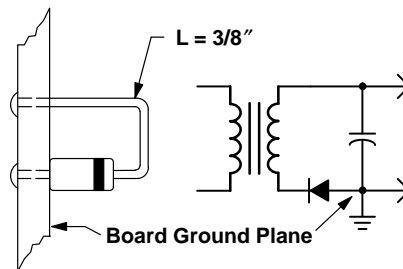

**P.C. Board with  
1-1/2" X 1-1/2" Copper Surface**

PACKAGE DIMENSIONS

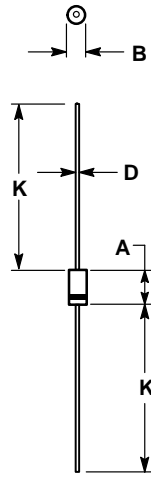

- NOTES:
1. ALL RULES AND NOTES ASSOCIATED WITH JEDEC DO-41 OUTLINE SHALL APPLY.
  2. POLARITY DENOTED BY CATHODE BAND.
  3. LEAD DIAMETER NOT CONTROLLED WITHIN F DIMENSION.

DIM	MILLIMETERS		INCHES	
	MIN	MAX	MIN	MAX
A	5.97	6.60	0.235	0.260
B	2.79	3.05	0.110	0.120
D	0.76	0.86	0.030	0.034
K	27.94	—	1.100	—

CASE 59-04  
ISSUE M

Motorola reserves the right to make changes without further notice to any products herein. Motorola makes no warranty, representation or guarantee regarding the suitability of its products for any particular purpose, nor does Motorola assume any liability arising out of the application or use of any product or circuit, and specifically disclaims any and all liability, including without limitation consequential or incidental damages. "Typical" parameters which may be provided in Motorola data sheets and/or specifications can and do vary in different applications and actual performance may vary over time. All operating parameters, including "Typicals" must be validated for each customer application by customer's technical experts. Motorola does not convey any license under its patent rights nor the rights of others. Motorola products are not designed, intended, or authorized for use as components in systems intended for surgical implant into the body, or other applications intended to support or sustain life, or for any other application in which the failure of the Motorola product could create a situation where personal injury or death may occur. Should Buyer purchase or use Motorola products for any such unintended or unauthorized application, Buyer shall indemnify and hold Motorola and its officers, employees, subsidiaries, affiliates, and distributors harmless against all claims, costs, damages, and expenses, and reasonable attorney fees arising out of, directly or indirectly, any claim of personal injury or death associated with such unintended or unauthorized use, even if such claim alleges that Motorola was negligent regarding the design or manufacture of the part. Motorola and  are registered trademarks of Motorola, Inc. Motorola, Inc. is an Equal Opportunity/Affirmative Action Employer.

Mfax is a trademark of Motorola, Inc.

**How to reach us:**

**USA/EUROPE/Locations Not Listed:** Motorola Literature Distribution;  
P.O. Box 5405, Denver, Colorado 80217. 1-303-675-2140 or 1-800-441-2447

**JAPAN:** Nippon Motorola Ltd.: SPD, Strategic Planning Office, 4-32-1,  
Nishi-Gotanda, Shinagawa-ku, Tokyo 141, Japan. 81-3-5487-8488

**Customer Focus Center: 1-800-521-6274**

**Mfax™:** RMFAX0@email.sps.mot.com – TOUCHTONE 1-602-244-6609  
Motorola Fax Back System – US & Canada ONLY 1-800-774-1848  
– http://sps.motorola.com/mfax/

**ASIA/PACIFIC:** Motorola Semiconductors H.K. Ltd.; 8B Tai Ping Industrial Park,  
51 Ting Kok Road, Tai Po, N.T., Hong Kong. 852-26629298

**HOME PAGE:** <http://motorola.com/sps/>

