

SWITCHMODE™ Power Rectifiers

... designed for use in switching power supplies, inverters and as free wheeling diodes, these state-of-the-art devices have the following features:

- Ultrafast 35 and 60 Nanosecond Recovery Time
- 175°C Operating Junction Temperature
- Popular TO-247 Package
- High Voltage Capability to 600 Volts
- Low Forward Drop
- Low Leakage Specified @ 150°C Case Temperature
- Current Derating Specified @ Both Case and Ambient Temperatures
- Epoxy Meets UL94, V₀ @ 1/8"
- High Temperature Glass Passivated Junction

Mechanical Characteristics

- Case: Epoxy, Molded
- Weight: 4.3 grams (approximately)
- Finish: All External Surfaces Corrosion Resistant and Terminal Leads are Readily Solderable
- Lead Temperature for Soldering Purposes: 260°C Max. for 10 Seconds
- Shipped 30 units per plastic tube
- Marking: U3020, U3040, U3060

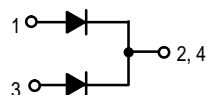

MUR3020WT
MUR3040WT
MUR3060WT

Motorola Preferred Devices

ULTRAFAST RECTIFIERS
30 AMPERES
200-400-600 VOLTS

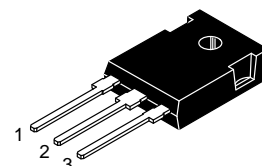

CASE 340K-01
TO-247AE

MAXIMUM RATINGS, PER LEG

Rating	Symbol	MUR3020WT	MUR3040WT	MUR3060WT	Unit
Peak Repetitive Reverse Voltage Working Peak Reverse Voltage DC Blocking Voltage	V _R RM V _R RWM V _R	200	400	600	Volts
Average Rectified Forward Current @ 145°C Total Device	I _F (AV)	15 30			Amps
Peak Repetitive Surge Current (Rated V _R , Square Wave, 20 kHz, T _C = 145°C)	I _{FM}	30			Amps
Nonrepetitive Peak Surge Current (Surge applied at rated load conditions, halfwave, single phase, 60 Hz)	I _{FSM}	200	150		Amps
Operating Junction and Storage Temperature	T _J , T _{stg}	- 65 to +175			°C

THERMAL CHARACTERISTICS, PER LEG

Maximum Thermal Resistance — Junction to Case — Junction to Ambient	R _θ JC R _θ JA	1.5 40	°C/W
--	--	-----------	------

ELECTRICAL CHARACTERISTICS, PER LEG

Maximum Instantaneous Forward Voltage (1) (I _F = 15 Amp, T _C = 150°C) (I _F = 15 Amp, T _C = 25°C)	V _F	0.85 1.05	1.12 1.25	1.4 1.7	Volts
Maximum Instantaneous Reverse Current (1) (Rated DC Voltage, T _J = 150°C) (Rated DC Voltage, T _J = 25°C)	i _R	500 10		1000 10	μA
Maximum Reverse Recovery Time (i _F = 1.0 A, di/dt = 50 Amps/μs)	t _{rr}	35	60		ns

(1) Pulse Test: Pulse Width = 300 μs, Duty Cycle ≤ 2.0%.

SWITCHMODE is a trademark of Motorola, Inc.

Preferred devices are Motorola recommended choices for future use and best overall value.

MUR3020WT MUR3040WT MUR3060WT

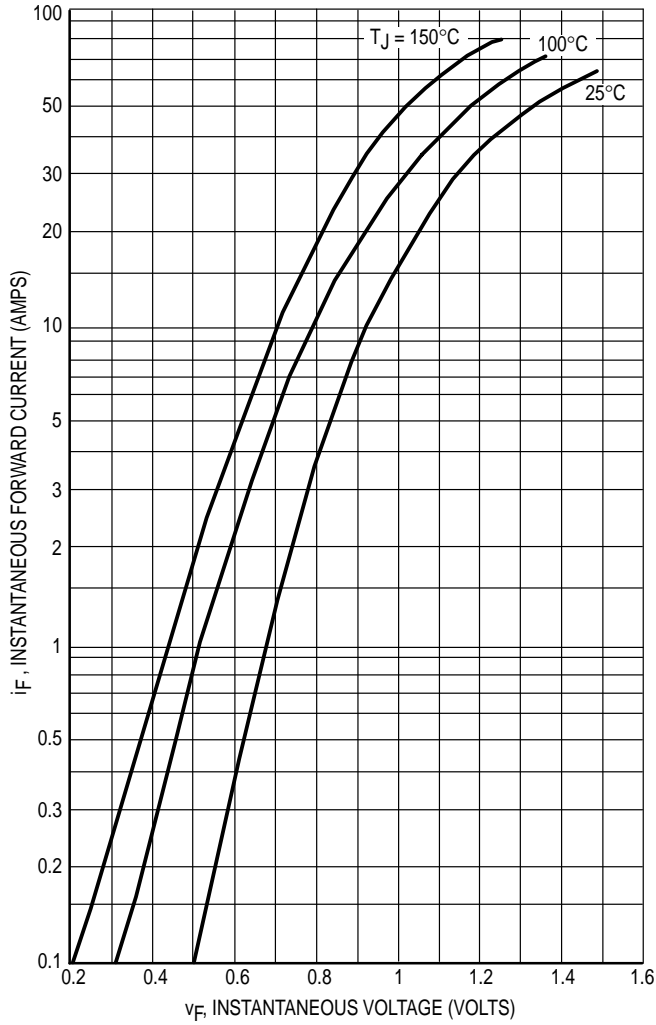
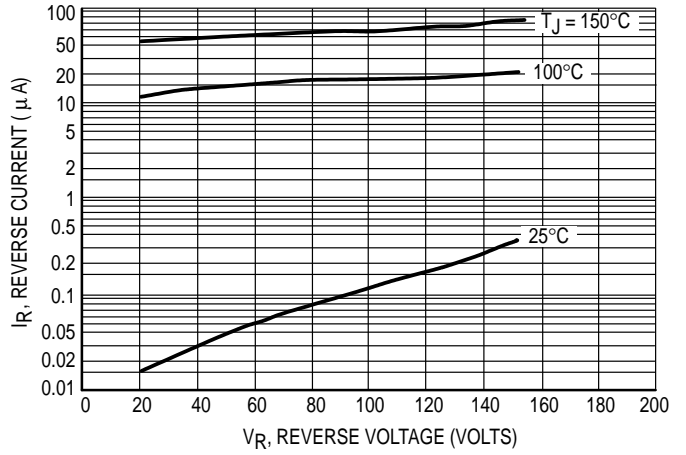

Figure 1. Typical Forward Voltage (Per Leg)



*The curves shown are typical for the highest voltage device in the voltage grouping. Typical reverse current for lower voltage selections can be estimated from these same curves if V_R is sufficiently below rated V_R .

Figure 2. Typical Reverse Current (Per Leg)*

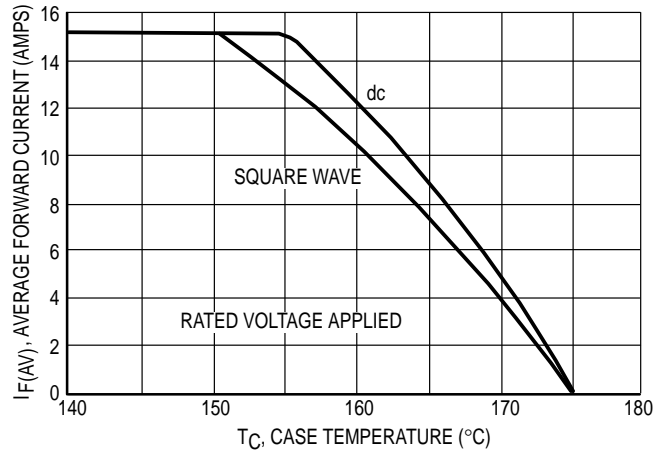

Figure 3. Current Derating, Case (Per Leg)

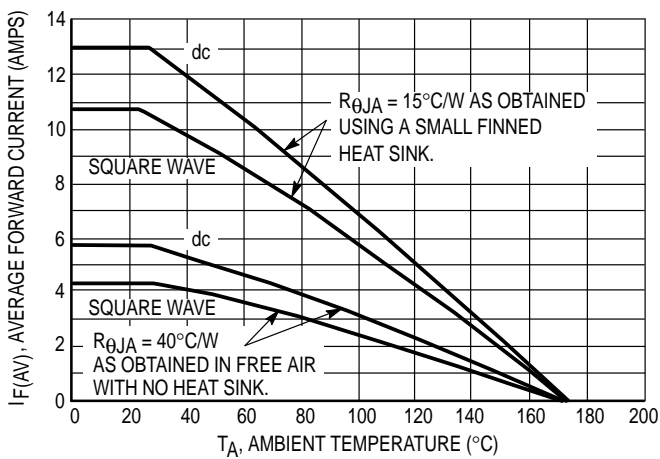

Figure 4. Current Derating, Ambient (Per Leg)

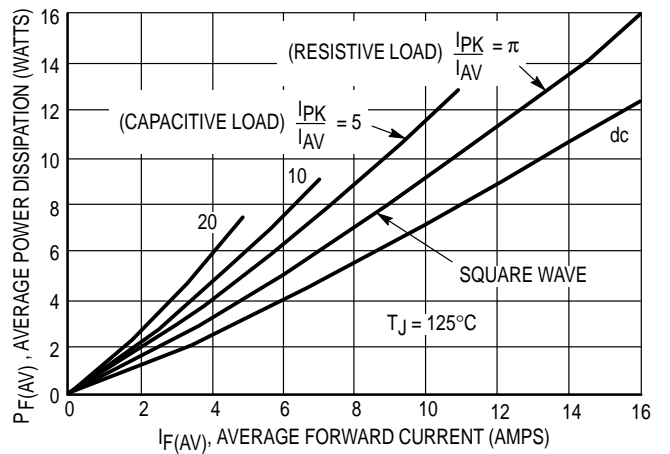

Figure 5. Power Dissipation (Per Leg)

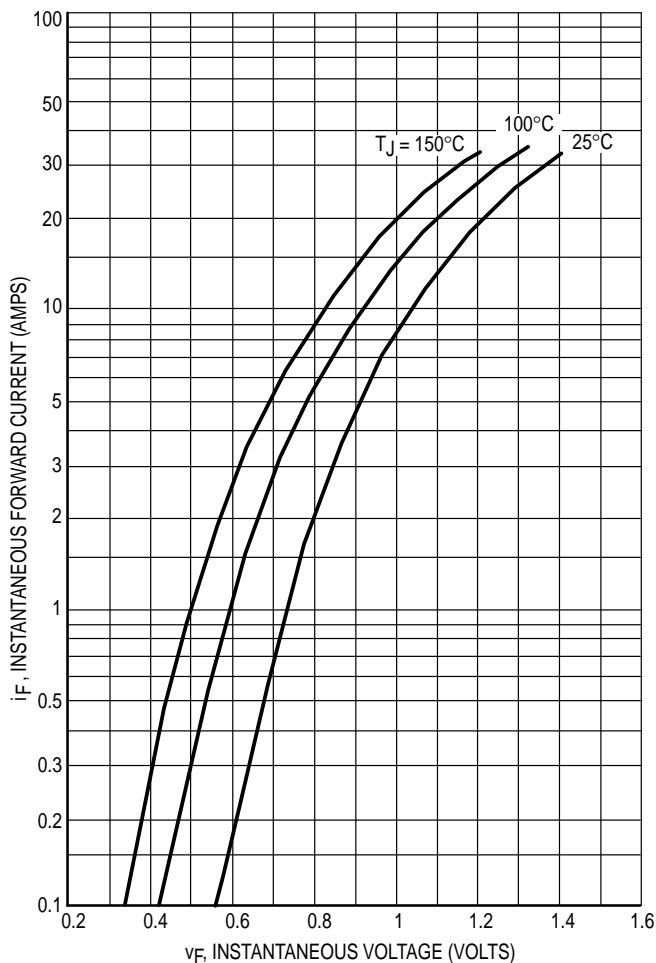
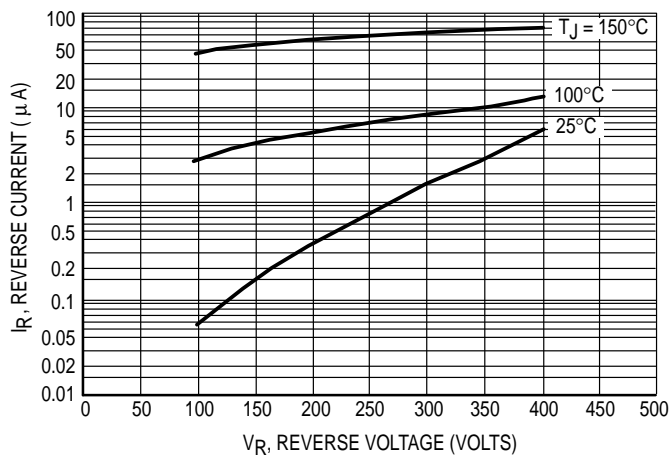

Figure 6. Typical Forward Voltage (Per Leg)



*The curves shown are typical for the highest voltage device in the voltage grouping. Typical reverse current for lower voltage selections can be estimated from these same curves if V_R is sufficiently below rated V_R .

Figure 7. Typical Reverse Current (Per Leg)*

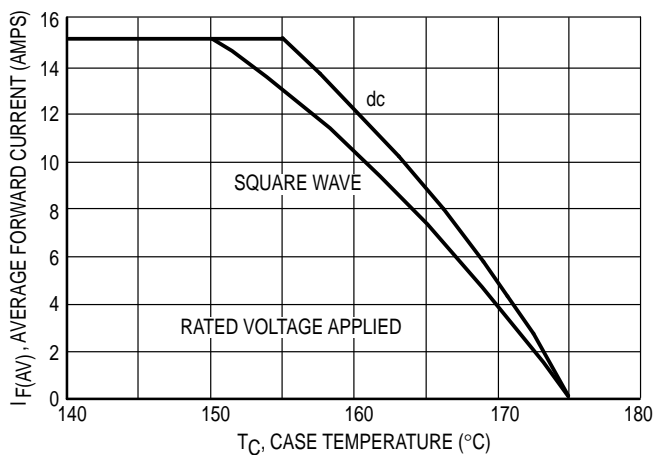

Figure 8. Current Derating, Case (Per Leg)

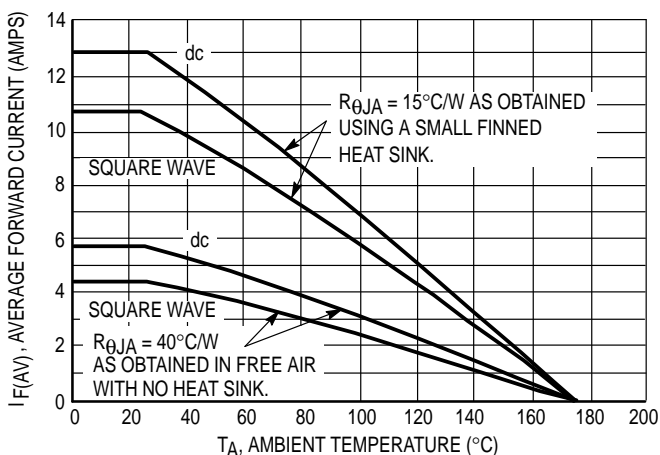

Figure 9. Current Derating, Ambient (Per Leg)

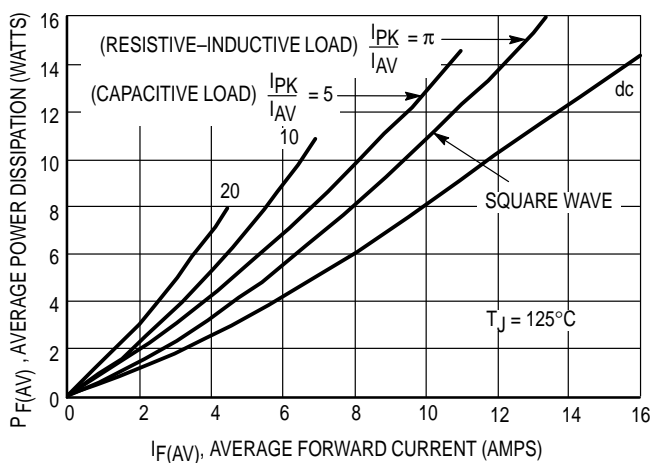

Figure 10. Power Dissipation (Per Leg)

MUR3020WT MUR3040WT MUR3060WT

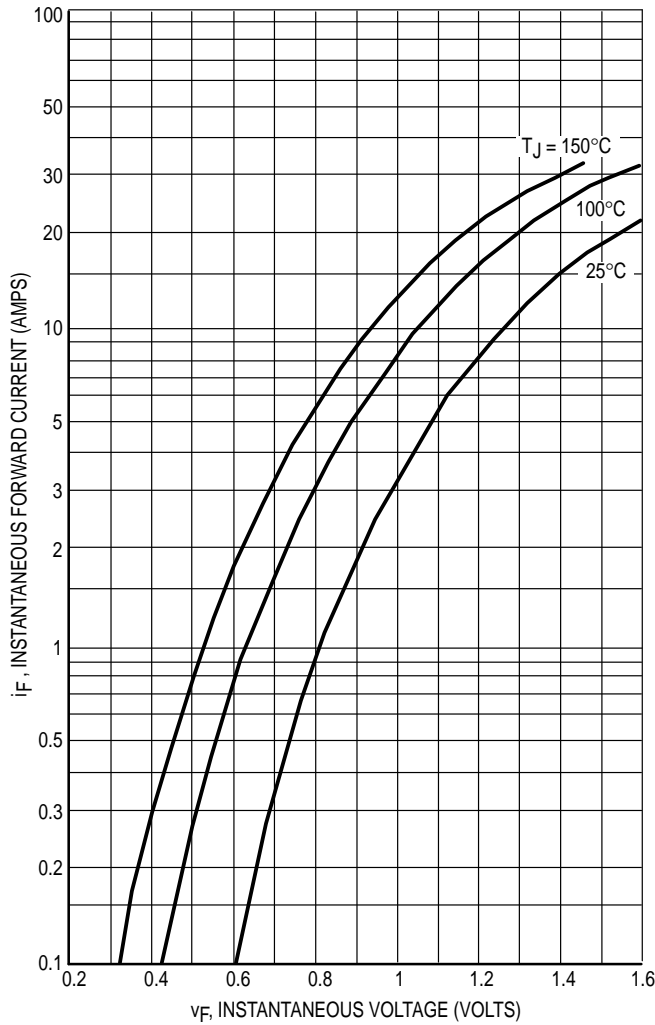
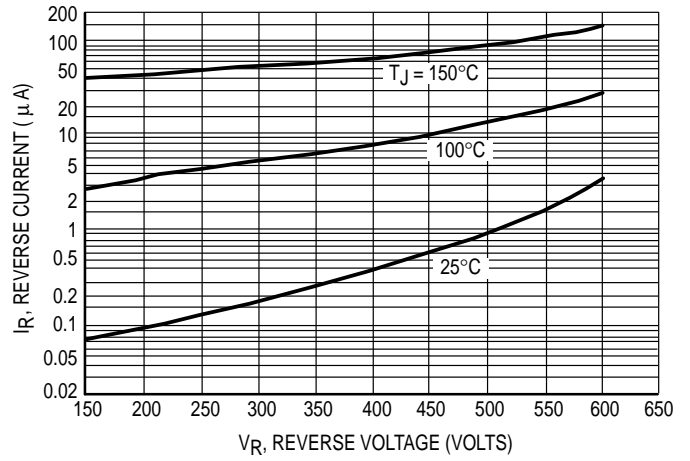

Figure 11. Typical Forward Voltage (Per Leg)



*The curves shown are typical for the highest voltage device in the voltage grouping. Typical reverse current for lower voltage selections can be estimated from these same curves if V_R is sufficiently below rated V_R .

Figure 12. Typical Reverse Current (Per Leg)*

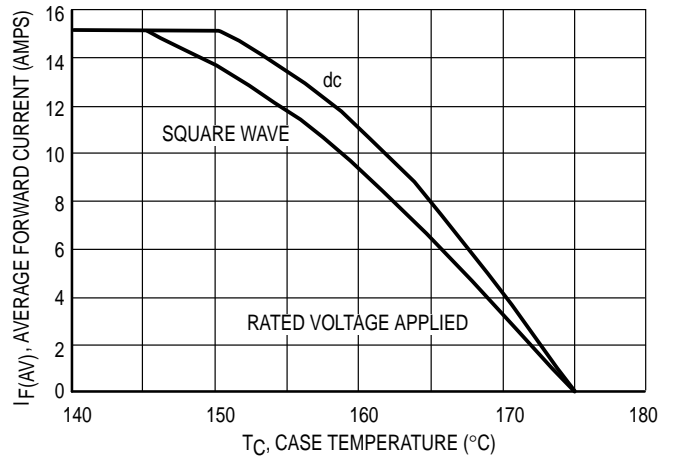

Figure 13. Current Derating, Case (Per Leg)

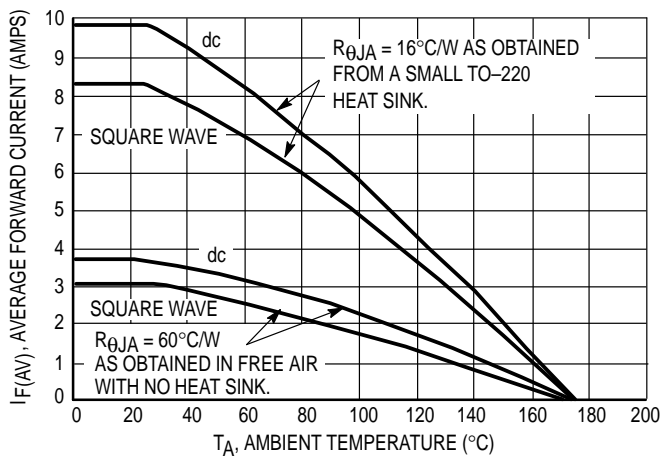

Figure 14. Current Derating, Ambient (Per Leg)

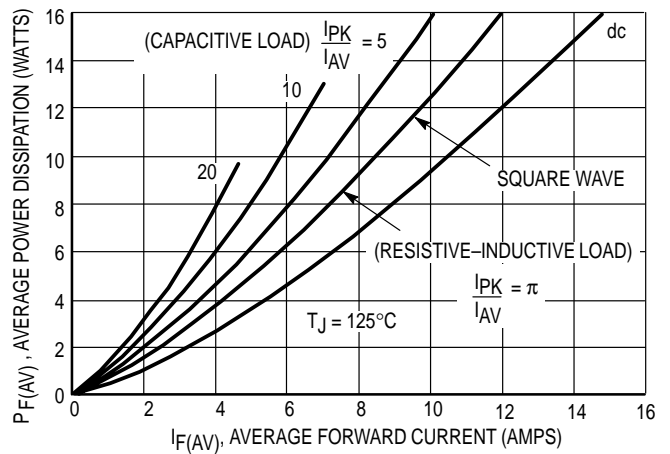

Figure 15. Power Dissipation (Per Leg)

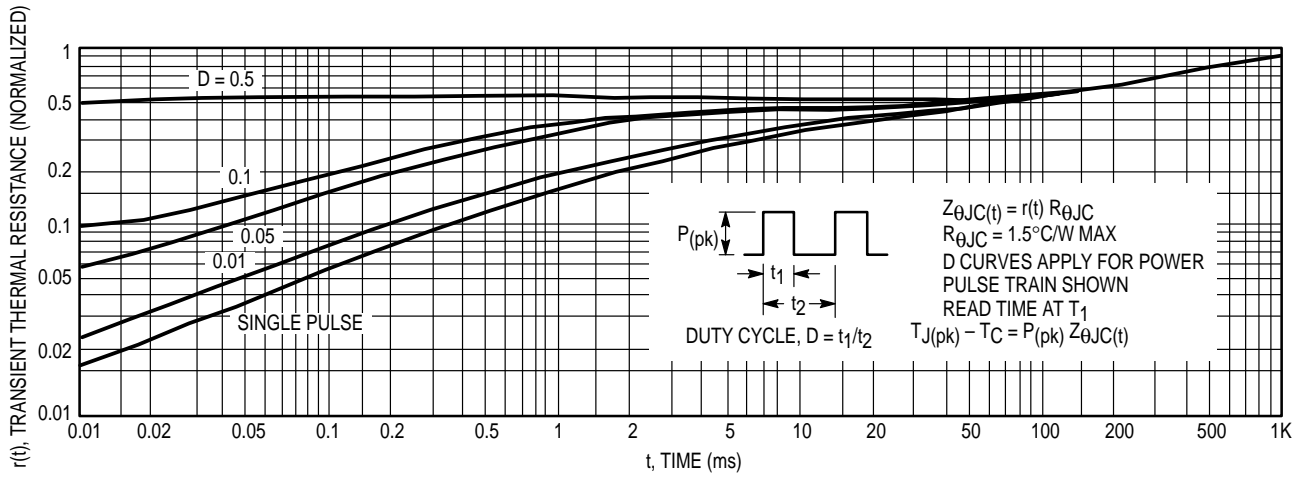

Figure 16. Thermal Response

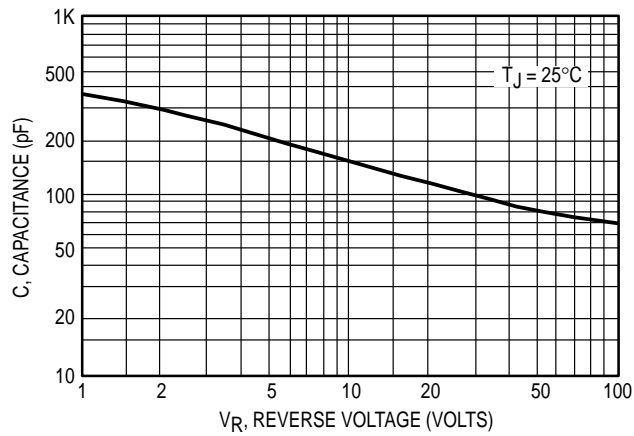
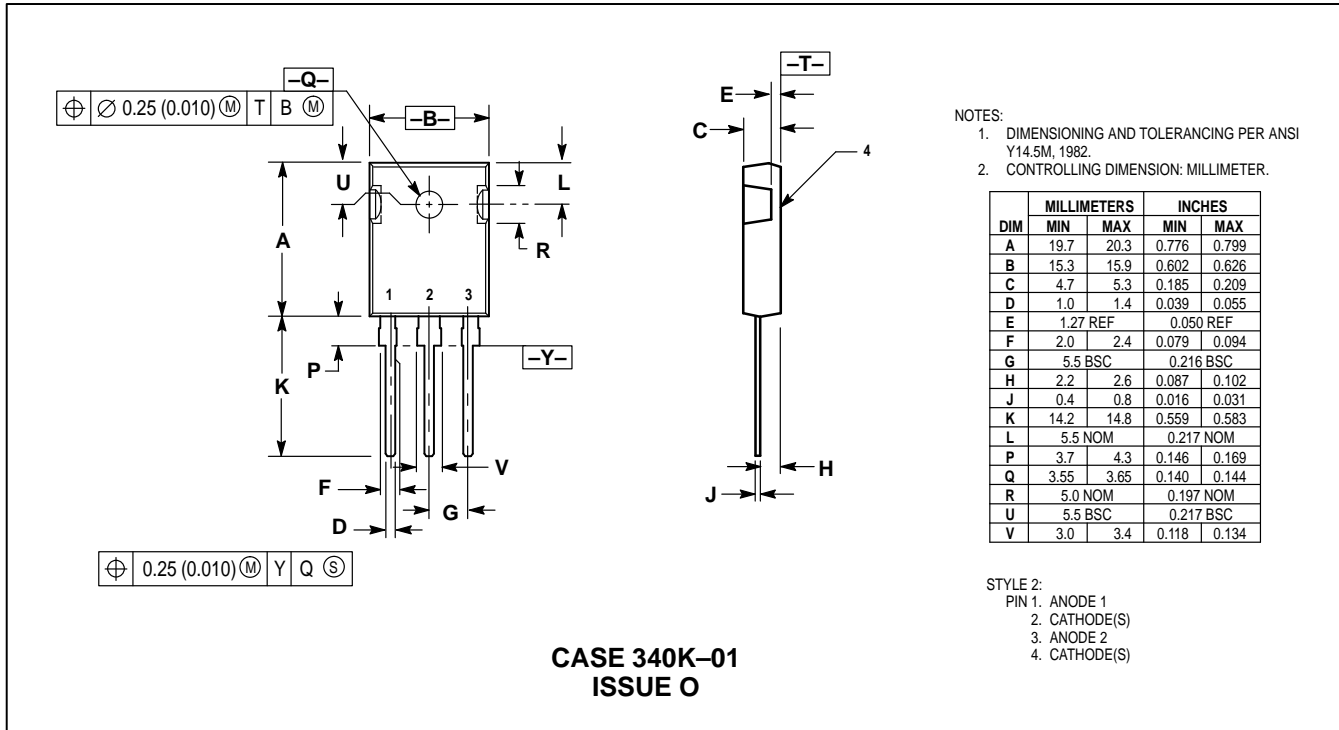

Figure 17. Typical Capacitance (Per Leg)

MUR3020WT MUR3040WT MUR3060WT

PACKAGE DIMENSIONS



Motorola reserves the right to make changes without further notice to any products herein. Motorola makes no warranty, representation or guarantee regarding the suitability of its products for any particular purpose, nor does Motorola assume any liability arising out of the application or use of any product or circuit, and specifically disclaims any and all liability, including without limitation consequential or incidental damages. "Typical" parameters which may be provided in Motorola data sheets and/or specifications can and do vary in different applications and actual performance may vary over time. All operating parameters, including "Typicals" must be validated for each customer application by customer's technical experts. Motorola does not convey any license under its patent rights nor the rights of others. Motorola products are not designed, intended, or authorized for use as components in systems intended for surgical implant into the body, or other applications intended to support or sustain life, or for any other application in which the failure of the Motorola product could create a situation where personal injury or death may occur. Should Buyer purchase or use Motorola products for any such unintended or unauthorized application, Buyer shall indemnify and hold Motorola and its officers, employees, subsidiaries, affiliates, and distributors harmless against all claims, costs, damages, and expenses, and reasonable attorney fees arising out of, directly or indirectly, any claim of personal injury or death associated with such unintended or unauthorized use, even if such claim alleges that Motorola was negligent regarding the design or manufacture of the part. Motorola and are registered trademarks of Motorola, Inc. Motorola, Inc. is an Equal Opportunity/Affirmative Action Employer.

Mfax is a trademark of Motorola, Inc.

How to reach us:

USA/EUROPE/Locations Not Listed: Motorola Literature Distribution;
 P.O. Box 5405, Denver, Colorado 80217. 303-675-2140 or 1-800-441-2447

JAPAN: Nippon Motorola Ltd.: SPD, Strategic Planning Office, 4-32-1,
 Nishi-Gotanda, Shinagawa-ku, Tokyo 141, Japan. 81-3-5487-8488

Mfax™: RMFAX0@email.sps.mot.com – TOUCHTONE 602-244-6609
 – US & Canada ONLY 1-800-774-1848

ASIA/PACIFIC: Motorola Semiconductors H.K. Ltd.; 8B Tai Ping Industrial Park,
 51 Ting Kok Road, Tai Po, N.T., Hong Kong. 852-26629298

INTERNET: <http://motorola.com/sps>

