



ONE-OF-TEN DECODER

The LSTTL/MSI SN54/74LS42 is a Multipurpose Decoder designed to accept four BCD inputs and provide ten mutually exclusive outputs. The LS42 is fabricated with the Schottky barrier diode process for high speed and is completely compatible with all Motorola TTL families.

- Multifunction Capability
- Mutually Exclusive Outputs
- Demultiplexing Capability
- Input Clamp Diodes Limit High Speed Termination Effects

CONNECTION DIAGRAM DIP (TOP VIEW)

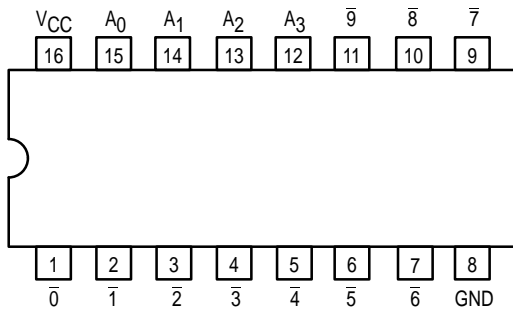

NOTE:
The Flatpak version has the same pinouts (Connection Diagram) as the Dual In-Line Package.

PIN NAMES

$A_0 - A_3$ Address Inputs
0 to 9 Outputs, Active LOW (Note b)

LOADING (Note a)

HIGH	LOW
0.5 U.L.	0.25 U.L.
10 U.L.	5(2.5) U.L.

NOTES:

- a) 1 TTL Unit Load (U.L.) = 40 μ A HIGH/1.6 mA LOW.
b) The Output LOW drive factor is 2.5 U.L. for Military (54) and 5 U.L. for Commercial (74) Temperature Ranges.

LOGIC DIAGRAM

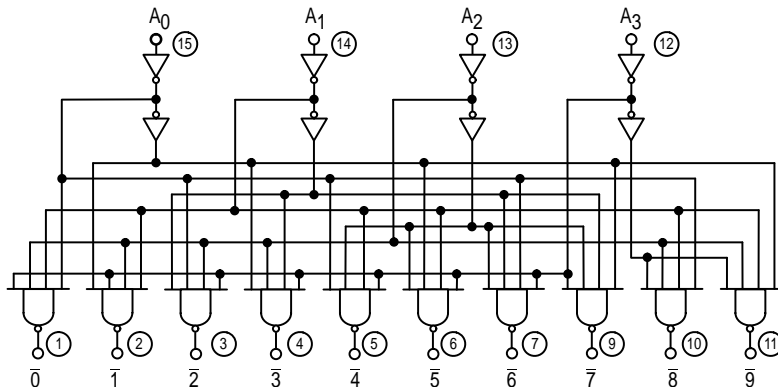

V_{CC} = PIN 16
GND = PIN 8
○ = PIN NUMBERS

SN54/74LS42

ONE-OF-TEN DECODER LOW POWER SCHOTTKY

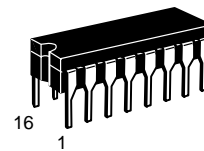

J SUFFIX
CERAMIC
CASE 620-09

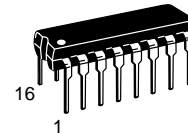

N SUFFIX
PLASTIC
CASE 648-08

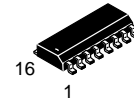

D SUFFIX
SOIC
CASE 751B-03

ORDERING INFORMATION

SN54LSXXJ Ceramic
SN74LSXXN Plastic
SN74LSXXD SOIC

LOGIC SYMBOL

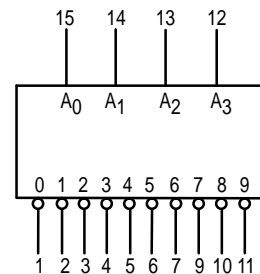

V_{CC} = PIN 16
GND = PIN 8

SN54/74LS42

FUNCTIONAL DESCRIPTION

The LS42 decoder accepts four active HIGH BCD inputs and provides ten mutually exclusive active LOW outputs, as shown by logic symbol or diagram. The active LOW outputs facilitate addressing other MSI units with LOW input enables.

The logic design of the LS42 ensures that all outputs are HIGH when binary codes greater than nine are applied

to the inputs.

The most significant input A₃ produces a useful inhibit function when the LS42 is used as a one-of-eight decoder. The A₃ input can also be used as the Data input in an 8-output demultiplexer application.

TRUTH TABLE

A ₀	A ₁	A ₂	A ₃	0	1	2	3	4	5	6	7	8	9
L	L	L	L	L	H	H	H	H	H	H	H	H	H
H	L	L	L	H	L	H	H	H	H	H	H	H	H
L	H	L	L	H	H	L	H	H	H	H	H	H	H
H	H	L	L	H	H	H	L	H	H	H	H	H	H
L	L	H	L	H	H	H	H	L	H	H	H	H	H
H	L	H	L	H	H	H	H	H	L	H	H	H	H
L	H	H	L	H	H	H	H	H	H	L	H	H	H
H	H	H	L	H	H	H	H	H	H	H	L	H	H
L	L	L	H	H	H	H	H	H	H	H	H	L	H
H	L	L	H	H	H	H	H	H	H	H	H	H	L
L	H	L	H	H	H	H	H	H	H	H	H	H	H
H	H	L	H	H	H	H	H	H	H	H	H	H	H
L	L	H	H	H	H	H	H	H	H	H	H	H	H
H	L	H	H	H	H	H	H	H	H	H	H	H	H
L	H	H	H	H	H	H	H	H	H	H	H	H	H
H	H	H	H	H	H	H	H	H	H	H	H	H	H

H = HIGH Voltage Level
L = LOW Voltage Level

GUARANTEED OPERATING RANGES

Symbol	Parameter		Min	Typ	Max	Unit
V _{CC}	Supply Voltage	54 74	4.5 4.75	5.0 5.0	5.5 5.25	V
T _A	Operating Ambient Temperature Range	54 74	-55 0	25 25	125 70	°C
I _{OH}	Output Current — High	54, 74			-0.4	mA
I _{OL}	Output Current — Low	54 74			4.0 8.0	mA

SN54/74LS42

DC CHARACTERISTICS OVER OPERATING TEMPERATURE RANGE (unless otherwise specified)

Symbol	Parameter		Limits			Unit	Test Conditions	
			Min	Typ	Max			
V_{IH}	Input HIGH Voltage		2.0			V	Guaranteed Input HIGH Voltage for All Inputs	
V_{IL}	Input LOW Voltage	54			0.7	V	Guaranteed Input LOW Voltage for All Inputs	
		74			0.8			
V_{IK}	Input Clamp Diode Voltage			-0.65	-1.5	V	$V_{CC} = \text{MIN}$, $I_{IN} = -18 \text{ mA}$	
V_{OH}	Output HIGH Voltage	54	2.5	3.5		V	$V_{CC} = \text{MIN}$, $I_{OH} = \text{MAX}$, $V_{IN} = V_{IH}$ or V_{IL} per Truth Table	
		74	2.7	3.5		V		
V_{OL}	Output LOW Voltage	54, 74		0.25	0.4	V	$I_{OL} = 4.0 \text{ mA}$	$V_{CC} = V_{CC} \text{ MIN}$, $V_{IN} = V_{IL}$ or V_{IH} per Truth Table
		74		0.35	0.5	V	$I_{OL} = 8.0 \text{ mA}$	
I_{IH}	Input HIGH Current				20	μA	$V_{CC} = \text{MAX}$, $V_{IN} = 2.7 \text{ V}$	
					0.1	mA	$V_{CC} = \text{MAX}$, $V_{IN} = 7.0 \text{ V}$	
I_{IL}	Input LOW Current				-0.4	mA	$V_{CC} = \text{MAX}$, $V_{IN} = 0.4 \text{ V}$	
I_{OS}	Short Circuit Current (Note 1)		-20		-100	mA	$V_{CC} = \text{MAX}$	
I_{CC}	Power Supply Current				13	mA	$V_{CC} = \text{MAX}$	

Note 1: Not more than one output should be shorted at a time, nor for more than 1 second.

AC CHARACTERISTICS ($T_A = 25^\circ\text{C}$)

Symbol	Parameter		Limits			Unit	Test Conditions	
			Min	Typ	Max			
t_{PLH} t_{PHL}	Propagation Delay (2 Levels)			15 15	25 25	ns	Figure 2	$V_{CC} = 5.0 \text{ V}$ $C_L = 15 \text{ pF}$
t_{PLH} t_{PHL}	Propagation Delay (3 Levels)			20 20	30 30	ns		

AC WAVEFORMS

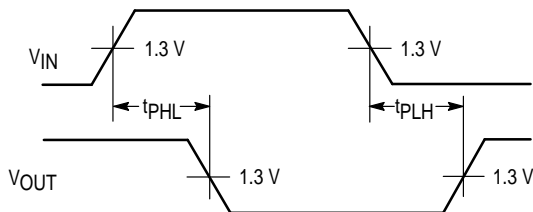

Figure 1

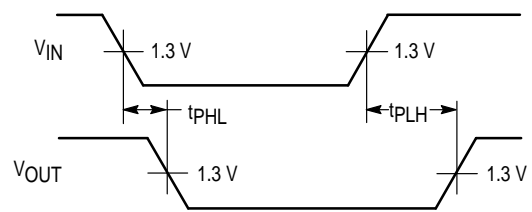

Figure 2