

MJLM108A-X REV 2A0

 Original Creation Date: 06/26/95
 Last Update Date: 04/16/99
 Last Major Revision Date: 04/06/99

OPERATIONAL AMPLIFIERS (SINGLE)
General Description

The LM108A is a precision operational amplifier having specifications a factor of ten better than FET amplifiers over a -55 C to +125 C temperature range.

The device operates with supply voltages from $\pm 2V$ to $\pm 20V$ and has sufficient supply rejection to use unregulated supplies. Although the circuit is interchangeable with and uses the same compensation as the LM101A, an alternate compensation scheme can be used to make it particularly insensitive to power supply noise and to make supply bypass capacitors unnecessary.

The low current error of the LM108A makes possible many designs that are not practical with conventional amplifiers. In fact, it operates from 10M Ohms source resistances, introducing less error than devices like the 709 with 10K Ohms sources. Integrators with drifts less than 500 uV/sec and analog time delays in excess of one hour can be made using capacitors no larger than 1uF.

Industry Part Number

LM108A

Prime Die

LM108A

Controlling Document

38510/10104,AMEND.4 CIR.C REV G

NS Part Numbers

 JL108ABCA
 JL108ABGA
 JL108ABHA
 JL108ABPA
 JL108ABZA
 JL108ASCA
 JL108ASGA
 JL108ASHA
 JL108ASPA

Processing

MIL-STD-883, Method 5004

Quality Conformance Inspection

MIL-STD-883, Method 5005

Subgrp	Description	Temp (°C)
1	Static tests at	+25
2	Static tests at	+125
3	Static tests at	-55
4	Dynamic tests at	+25
5	Dynamic tests at	+125
6	Dynamic tests at	-55
7	Functional tests at	+25
8A	Functional tests at	+125
8B	Functional tests at	-55
9	Switching tests at	+25
10	Switching tests at	+125
11	Switching tests at	-55

(Absolute Maximum Ratings)

(Note 1)

Supply Voltage		±22V
Power Dissipation (Note 2)		
METAL CAN		330mW @ +125 C
CERDIP, 14 Lead		400mW @ +125 C
CERDIP, 8 Lead		400mW @ +125 C
CERPACK, 10 Lead		330mW @ +125 C
CERAMIC SOIC		330mW @ +125 C
Differential Input Current (Note 3)		±10mA
Differential Input Voltage (Note 5)		±30V
Input Voltage (Note 4)		±20V
Output Short-Circuit Duration		Continuous
Operating Temperature Range		-55 C to +125 C
Storage Temperature Range		-65 C to +150 C
Thermal Resistance ThetaJA		
METAL CAN	(Still Air)	150 C/W
	(500LF/Min Air flow)	86 C/W
CERDIP, 14 Lead	(Still Air)	94 C/W
	(500LF/Min Air flow)	55 C/W
CERDIP, 8 Lead	(Still Air)	120 C/W
	(500LF/Min Air flow)	68 C/W
CERPACK, 10 Lead	(Still Air)	225 C/W
	(500LF/Min Air flow)	142 C/W
CERAMIC SOIC	(Still Air)	225 C/W
	(500LF/Min Air Flow)	142 C/W
ThetaJC		
METAL CAN		38 C/W
CERDIP, 14 Lead		13 C/W
CERDIP, 8 Lead		17 C/W
CERPACK, 10 Lead		21 C/W
CERAMIC SOIC		21 C/W
Package Weight (Typical)		
METAL CAN		990mg
CERDIP, 14 Lead		2180mg
CERDIP, 8 Lead		1090mg
CERPACK, 10 Lead		255mg
CERAMIC SOIC		210mg
Maximum Junction Temperature		175 C
Soldering Information (Soldering, 10 seconds)		300 C
ESD Tolerance (Note 6)		2000V

- Note 1: Absolute Maximum Ratings indicate limits beyond which damage to the device may occur. Operating Ratings indicate conditions for which the device is functional, but do not guarantee specific performance limits. For guaranteed specifications and test conditions, see the Electrical Characteristics. The guaranteed specifications apply only for the test conditions listed. Some performance characteristics may degrade when the device is not operated under the listed test conditions.
- Note 2: The maximum power dissipation must be derated at elevated temperatures and is dictated by T_{jmax} (maximum junction temperature), Θ_{JA} (package junction to ambient thermal resistance), and T_A (ambient temperature). The maximum allowable power dissipation at any temperature is $P_{dmax} = (T_{jmax} - T_A) / \Theta_{JA}$ or the number given in the Absolute Maximum Ratings, whichever is lower.
- Note 3: The inputs are shunted with back-to-back diodes for overvoltage protection. Therefore, excessive current will flow if a differential input voltage in excess of 1V is applied between the inputs unless some limiting resistance is used.
- Note 4: For supply voltages less than $\pm 20V$, the absolute maximum input voltage is equal to the supply voltage.
- Note 5: This rating is $\pm 1.0V$ unless resistances of 2K Ohms or greater are inserted in series with the inputs to limit current in the input shunt diodes to the maximum allowable value.
- Note 6: Human body model, 1.5K Ohms in series with 100pF.

Electrical Characteristics

DC PARAMETERS

(The following conditions apply to all the following parameters, unless otherwise specified.)
 DC: $\pm V_{CC} = \pm 20V$, $V_{CM} = 0V$, $R_S = 50 \text{ Ohms}$

SYMBOL	PARAMETER	CONDITIONS	NOTES	PIN-NAME	MIN	MAX	UNIT	SUB-GROUPS
Vio	Input Offset Voltage	$+V_{CC} = 35V, -V_{CC} = -5V, V_{CM} = -15V$			-0.5	0.5	mV	1
					-1	1	mV	2, 3
		$+V_{CC} = 5V, -V_{CC} = -35V, V_{CM} = 15V$			-0.5	0.5	mV	1
					-1	1	mV	2, 3
					-0.5	0.5	mV	1
					-1	1	mV	2, 3
$+V_{CC} = +5V, -V_{CC} = -5V$			-0.5	0.5	mV	1		
			-1	1	mV	2, 3		
Delta Vio/Delta T	Temperature Coefficient of Input Offset Voltage	$25 \text{ C} \leq T_A \leq +125 \text{ C}$	1		-5	5	$\mu V/C$	2
		$25 \text{ C} \leq T_A \leq -55 \text{ C}$	1		-5	5	$\mu V/C$	3
Iio	Input Offset Current	$+V_{CC} = 35V, -V_{CC} = -5V, V_{CM} = -15V$			-0.2	0.2	nA	1
					-0.4	0.4	nA	2, 3
		$+V_{CC} = 5V, -V_{CC} = -35V, V_{CM} = 15V$			-0.2	0.2	nA	1
					-0.4	0.4	nA	2, 3
					-0.2	0.2	nA	1
					-0.4	0.4	nA	2, 3
$+V_{CC} = +5V, -V_{CC} = -5V$			-0.2	0.2	nA	1		
			-0.4	0.4	nA	2, 3		
Delta Iio/Delta T	Temperature Coefficient of Input Offset Current	$25 \text{ C} \leq T_A \leq +125 \text{ C}$	1		-2.5	2.5	pA/C	2
		$25 \text{ C} \leq T_A \leq -55 \text{ C}$	1		-2.5	2.5	pA/C	3

Electrical Characteristics

DC PARAMETERS (Continued)

(The following conditions apply to all the following parameters, unless otherwise specified.)
 DC: $\pm V_{CC} = \pm 20V$, $V_{cm} = 0V$, $R_s = 50 \text{ Ohms}$

SYMBOL	PARAMETER	CONDITIONS	NOTES	PIN-NAME	MIN	MAX	UNIT	SUB-GROUPS
+Iib	Input Bias Current	+Vcc = 35V, -Vcc = -5V, Vcm = -15V			-0.1	2	nA	1
					-1	2	nA	2
					-0.1	3	nA	3
		+Vcc = 5V, -Vcc = -35V, Vcm = 15V			-0.1	2	nA	1
					-1	2	nA	2
					-0.1	3	nA	3
					-0.1	2	nA	1
					-1	2	nA	2
					-0.1	3	nA	3
		+Vcc = +5V, -Vcc = -5V			-0.1	2	nA	1
					-1	2	nA	2
					-0.1	3	nA	3
-Iib	Input Bias Current	+Vcc = 35V, -Vcc = -5V, Vcm = -15V			-0.1	2	nA	1
					-1	2	nA	2
					-0.1	3	nA	3
		+Vcc = 5V, -Vcc = -35V, Vcm = 15V			-0.1	2	nA	1
					-1	2	nA	2
					-0.1	3	nA	3
					-0.1	2	nA	1
					-1	2	nA	2
					-0.1	3	nA	3
		+Vcc = +5V, -Vcc = -5V			-0.1	2	nA	1
					-1	2	nA	2
					-0.1	3	nA	3
+PSRR	Power Supply Rejection Ratio	+Vcc = 10V, -Vcc = -20V			-16	16	uV/V	1, 2, 3
-PSRR	Power Supply Rejection Ratio	+Vcc = 20V, -Vcc = -10V			-16	16	uV/V	1, 2, 3
CMRR	Common Mode Rejection Ratio	Vcm = $\pm 15V$			96		dB	1, 2, 3
Ios+	Short Circuit Current	+Vcc = +15V, -Vcc = -15V, $t \leq 25mS$			-15		mA	1, 2, 3

Electrical Characteristics

DC PARAMETERS (Continued)

(The following conditions apply to all the following parameters, unless otherwise specified.)
DC: $\pm V_{CC} = \pm 20V$, $V_{CM} = 0V$, $R_S = 50 \text{ Ohms}$

SYMBOL	PARAMETER	CONDITIONS	NOTES	PIN-NAME	MIN	MAX	UNIT	SUB-GROUPS
Ios-	Short Circuit Current	$+V_{CC} = +15V$, $-V_{CC} = -15V$, $t \leq 25mS$				15	mA	1, 2, 3
Icc	Power Supply Current	$+V_{CC} = +15V$, $-V_{CC} = -15V$				0.6	mA	1, 2
						0.8	mA	3

AC/DC PARAMETERS

(The following conditions apply to all the following parameters, unless otherwise specified.)
DC: $\pm V_{CC} = \pm 20V$, $V_{CM} = 0V$, $R_S = 50 \text{ Ohms}$
AC: $\pm V_{CC} = \pm 20V$, $V_{CM} = 0V$, $R_S = 50 \text{ Ohms}$

+Vop	Output Voltage Swing	$R_L = 10K \text{ Ohms}$			16		V	4, 5, 6
-Vop	Output Voltage Swing	$R_L = 10K \text{ Ohms}$				-16	V	4, 5, 6
Avs+	Open Loop Voltage Gain	$R_L = 10K \text{ Ohms}$, $V_{out} = +15V$	3		80		V/mV	4
			3		40		V/mV	5, 6
Avs-	Open Loop Voltage Gain	$R_L = 10K \text{ Ohms}$, $V_{out} = -15V$	3		80		V/mV	4
			3		40		V/mV	5, 6
Avs	Open Loop Voltage Gain	$\pm V_{CC} = \pm 5V$, $R_L = 10K \text{ Ohms}$, $V_{out} = \pm 2V$	3		20		V/mV	4, 5, 6
TR(tr)	Transient Response Rise Time	$R_L = 10K \text{ Ohms}$, $C_L = 100pF$, $f < 1KHz$, $V_{in} = +50mV$	4			1000	nS	7, 8A, 8B
TR(os)	Transient Response Overshoot	$R_L = 10K \text{ Ohms}$, $C_L = 100pF$, $f < 1KHz$, $V_{in} = +50mV$	4			50	%	7, 8A, 8B
Sr(+)	Slew Rate	$A_v = 1$, $V_{in} = -5V \text{ to } +5V$			0.05		V/uS	7, 8A, 8B
Sr(-)	Slew Rate	$A_v = 1$, $V_{in} = +5V \text{ to } -5V$			0.05		V/uS	7, 8A, 8B
NI(BB)	Noise Broadband	$BW = 10Hz \text{ to } 5KHz$, $R_S = 0 \text{ Ohms}$	2			15	μV_{rms}	7
NI(PC)	Noise Popcorn	$BW = 10Hz \text{ to } 5KHz$, $R_S = 100K \text{ Ohms}$	2			40	μV_{pk}	7

Electrical Characteristics

DC PARAMETERS: DRIFT VALUES

(The following conditions apply to all the following parameters, unless otherwise specified.)

DC: $\pm V_{cc} = \pm 20V$, $V_{cm} = 0V$, $R_s = 50 \text{ Ohms}$. "Delta calculations performed on JAN S and QMLV devices at group B, subgroup 5 only".

SYMBOL	PARAMETER	CONDITIONS	NOTES	PIN-NAME	MIN	MAX	UNIT	SUB-GROUPS
Vio	Input Offset Voltage				-0.25	0.25	mV	1
+Iib	Input Bias Current				-0.5	0.5	nA	1
-Iib	Input Bias Current				-0.5	0.5	nA	1

Note 1: Calculated parameter.

Note 2: Test on either A360, J273 AC or bench test.

Note 3: Datalog reading in K = V/mV.

Note 4: Bench test.

Graphics and Diagrams

GRAPHICS#	DESCRIPTION
05090HRB2	CERDIP (J), 8 LEAD (B/I CKT)
05115HRA2	CERPACK (W), 10 LEAD (B/I CKT)
05116HRA2	METAL CAN (H), TO-99, 8LD .200 DIA P.C. (B/I CKT)
05261HRB3	METAL CAN (H), TO-99, 8LD .200 DIA P.C. (B/I CKT)
05340HRA3	CERDIP (J), 14 LEAD (B/I CKT)
05354HRB2	CERDIP (J), 14 LEAD (B/I CKT)
05389HRA3	CERPACK (W), 10 LEAD (B/I CKT)
05529HRA2	CERDIP (J), 8 LEAD (B/I CKT)
H08CRF	METAL CAN (H), TO-99, 8LD, .200 DIA P.C. (P/P DWG)
J08ARL	CERDIP (J), 8 LEAD (P/P DWG)
J14ARH	CERDIP (J), 14 LEAD (P/P DWG)
P000253A	CERAMIC SOIC (WG), 10 LEAD (PINOUT)
P000310A	METAL CAN (H), TO-99, 8LD, .200 DIA P.C. (PINOUT)
P000311A	CERDIP (J), 14 LEAD (PINOUT)
P000312A	CERDIP (J), 8 LEAD (PINOUT)
P000431A	CERPACK (W), 10 LEAD (PINOUT)
W10ARG	CERPACK (W), 10 LEAD (P/P DWG)
WG10ARC	CERAMIC SOIC (WG), 10 LEAD (P/P DWG)

See attached graphics following this page.

REVISIONS

LTR	DESCRIPTION	E.C. N.	DATE	BY/APP'D
F	REVISE & REDRAW PER CURRENT STANDARD; UPDATE MIL/AERO STAMP & TITLE.	11002	06/22/95	MS/

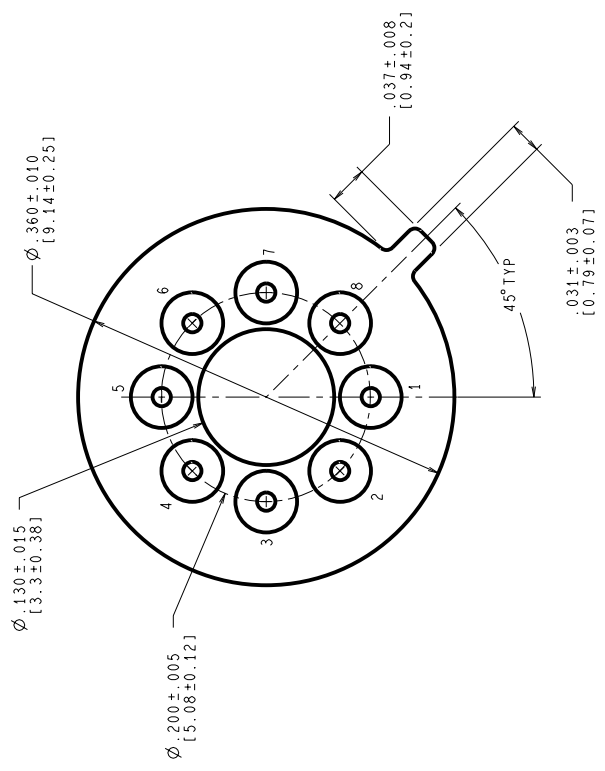
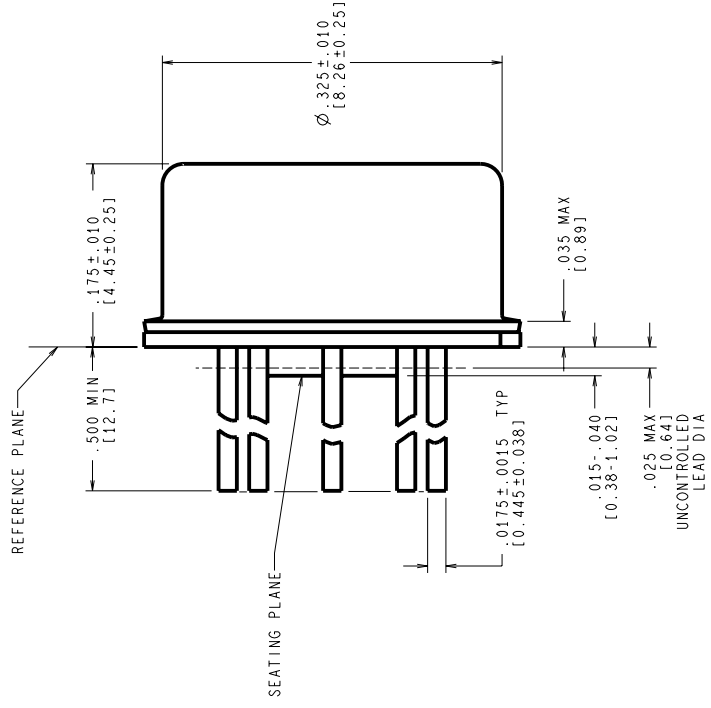

CONTROLLING DIMENSION IS INCH
VALUES IN [] ARE MILLIMETERS

MIL-I-38535
CONFIGURATION CONTROL

NOTES: UNLESS OTHERWISE SPECIFIED

- LEADS TO BE LOCATED WITHIN .007 IN/ 0.18 mm OF THEIR TRUE POSITIONS RELATIVE TO A MAXIMUM WIDTH TAB.
- STANDARD METAL CAN TYPE: SOLID BASE WITH CERAMIC STANDOFF.
- APPLIES TO MIL-AERO AND LINEAR PRODUCTS.
- REFERENCE JEDEC REGISTRATION TO-99, JEDEC PUBLICATION No. 95.

APPROVALS	DATE
DRN: MARTA SUCHY	06/22/95
DWG. CHK.	
ENGR. CHK.	

National Semiconductor 2800 Semiconductor Dr., Santa Clara, CA 95052-8090	
METAL CAN, TO-99, 8 LEAD, .200 DIA P.C.	
SCALE	N/A
SIZE	C
DRAWING NUMBER	MKT-H08C
REV	F

PROJECTION	
DO NOT SCALE DRAWING	
SHEET 1 of 1	

REV I S I O N S

LTR	DESCRIPTION	E.C.N.	DATE	BY/APP'D
L	REVISE PER CURRENT STD; REDRAW	10002	09/21/93	TL/

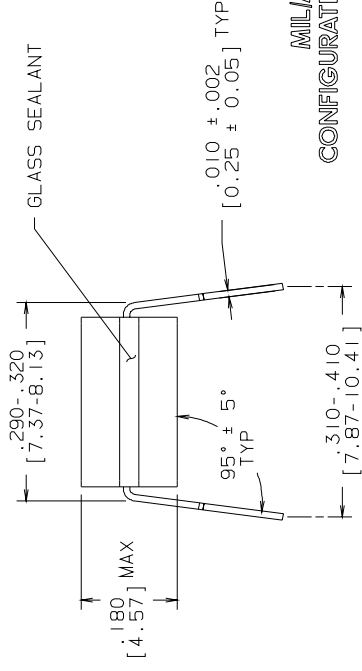
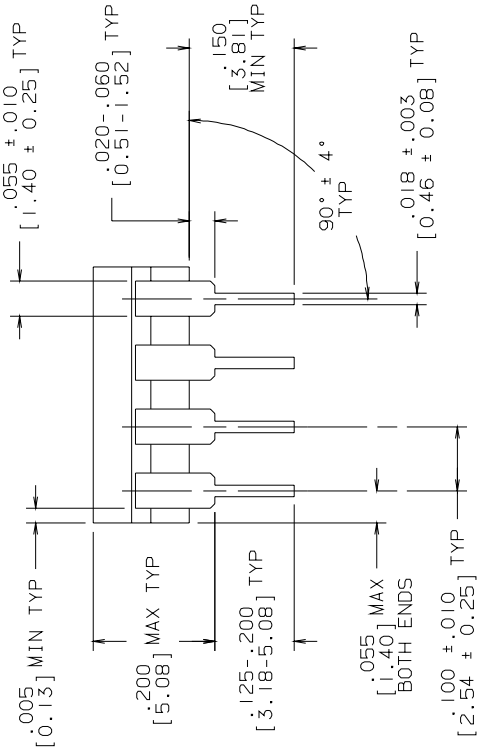
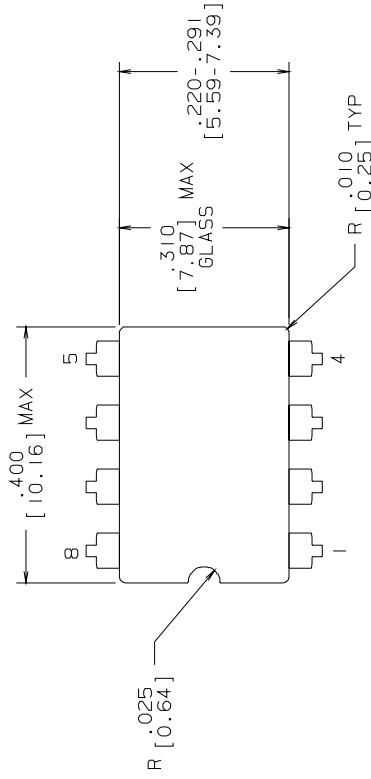

MILAERO
CONFIGURATION CONTROL
MIL-M-38510
CONFIGURATION CONTROL

CONTROLLING DIMENSION: INCH

APPROVALS	DATE	NATIONAL SEMICONDUCTOR CORPORATION 2900 Semiconductor Drive, Santa Clara, CA 95052-8090	
DRAWN T. LEQUANG	09/21/93	SCALE	REV
DFTG. CHK.		N/A	B
ENGR. CHK.		SIZE	MKT-J08A
APPROVAL		DRAWING NUMBER	L
 INCH [MM]		DO NOT SCALE DRAWING	SHEET
		1	OF 1

NOTES: UNLESS OTHERWISE SPECIFIED

- LEAD FINISH TO BE 200 MICROMETERS / 5.08 MICROMETERS MINIMUM SOLDER MEASURED AT THE CREST OF THE MAJOR FLATS.
- JEDEC REGISTRATION MO-036, VARIATION AA, DATED 04/1981.

CERDIP (J),
8 LEAD

R E V I S I O N S			
LTR	DESCRIPTION	E.C.N.	DATE
H	REVISE PER CURRENT STD; REDRAW	10001	09/15/93
			TL/

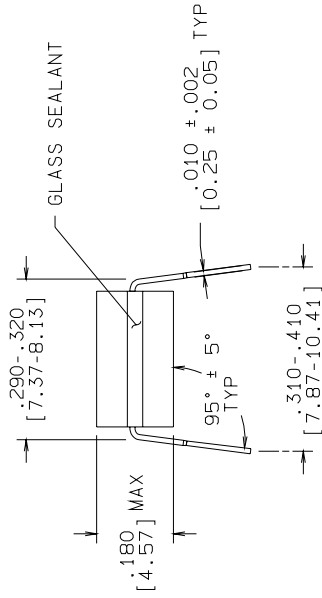
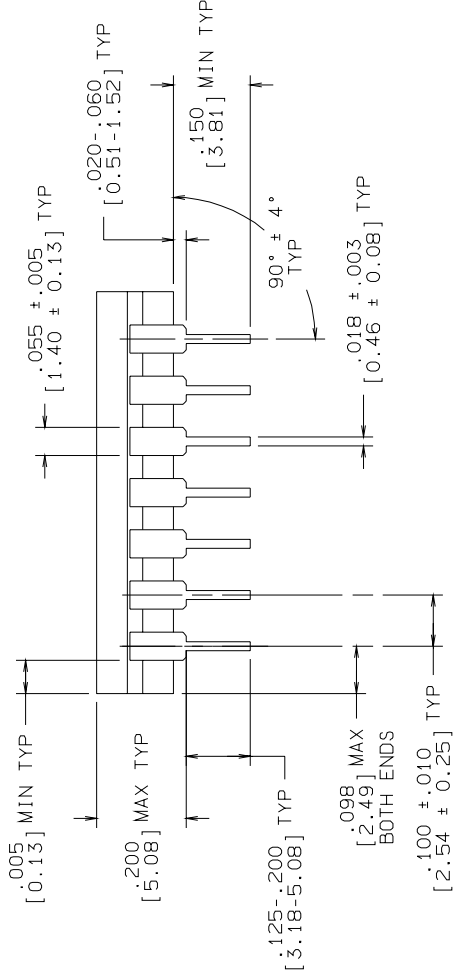
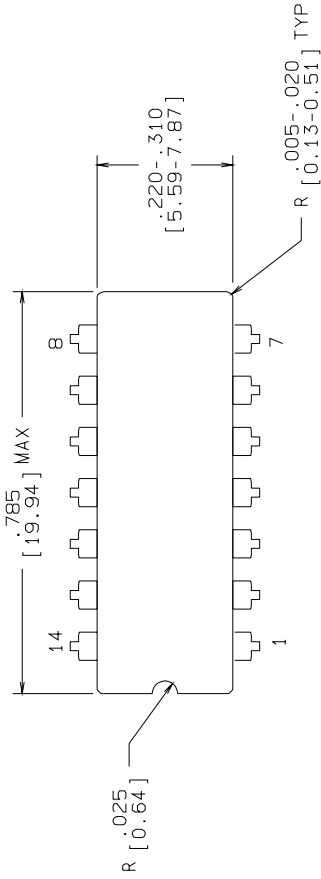

CONTROLLING DIMENSION: INCH

NOTES: UNLESS OTHERWISE SPECIFIED

1. LEAD FINISH TO BE 200 MICRONS / 5.08 MICROMETERS MINIMUM SOLDER MEASURED AT THE CREST OF THE MAJOR FLATS.
2. JEDEC REGISTRATION MO-036, VARIATION AB, DATED 04/1981.

MIL/AERO MIL-M-38510
 CONFIGURATION CONTROL CONFIGURATION CONTROL

APPROVALS	DATE	NATIONAL SEMICONDUCTOR CORPORATION	
DRAWN: T. LEQUANG	09/15/93	2900 Semiconductor Drive, Santa Clara, CA 95052-8090	
DFTG. CHK.			
ENGR. CHK.			
APPROVAL			
 PROJECTION INCH [MM]	SCALE	SIZE	DRAWING NUMBER
	N/A	B	MKT-J14A
	DO NOT SCALE DRAWING	SHEET	1 OF 1
		REV	H

CERDIP (J),
 14 LEAD,

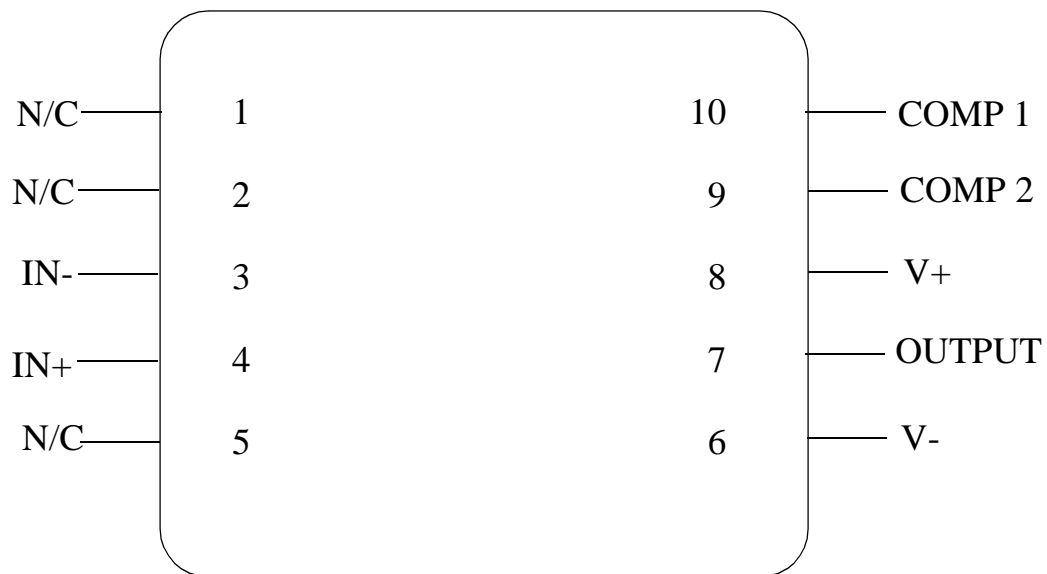

LM108AWG
10 - LEAD CERAMIC SOIC
CONNECTION DIAGRAM
TOP VIEW
P000253A



National Semiconductor™
MIL/AEROSPACE OPERATIONS
2900 SEMICONDUCTOR DRIVE
SANTA CLARA, CA 95050

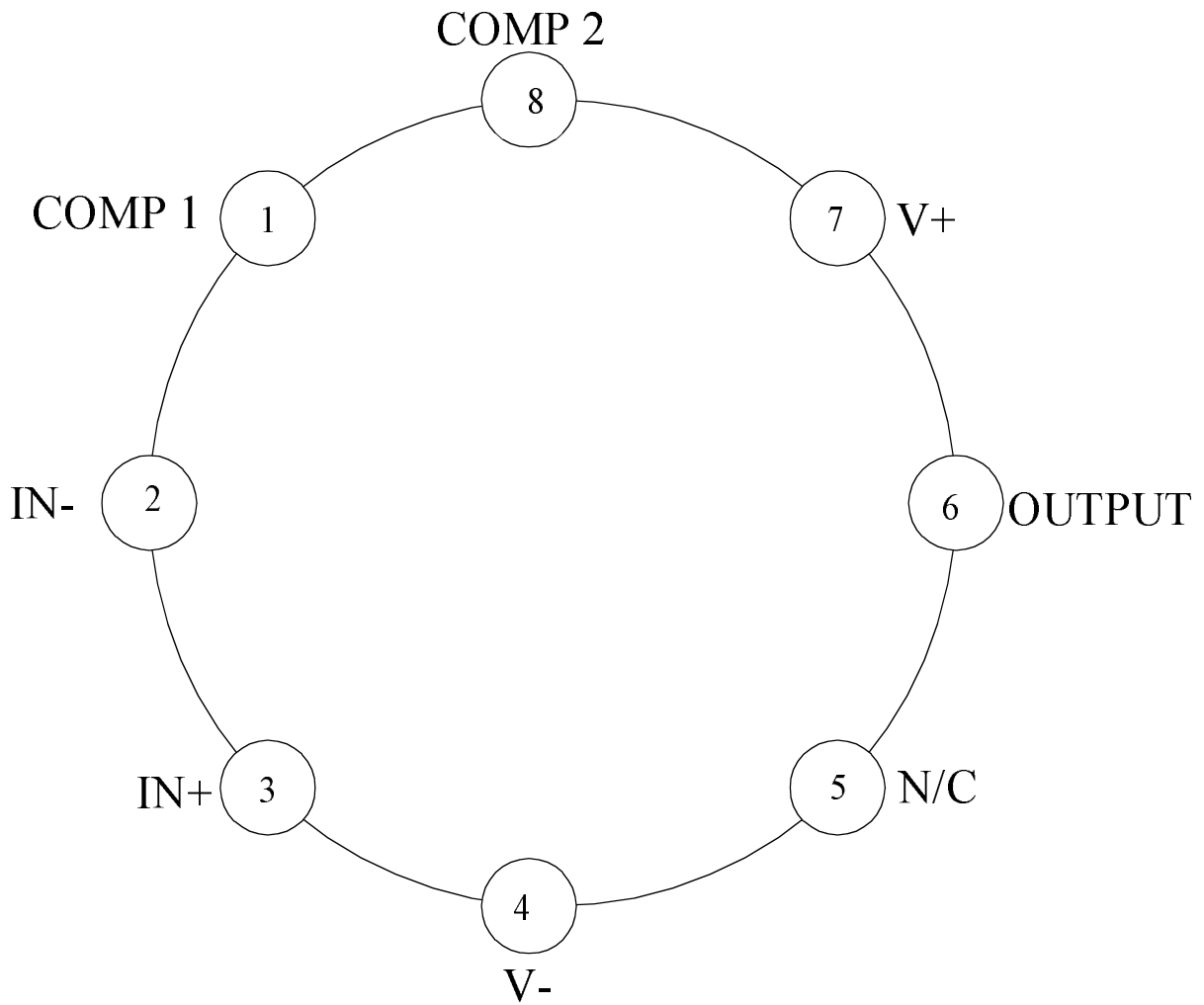

LM108AH, LM108H
8 - PIN METAL CAN
CONNECTION DIAGRAM
TOP VIEW
P000310A



National Semiconductor™
MIL/AEROSPACE OPERATIONS
2900 SEMICONDUCTOR DRIVE
SANTA CLARA, CA 95050

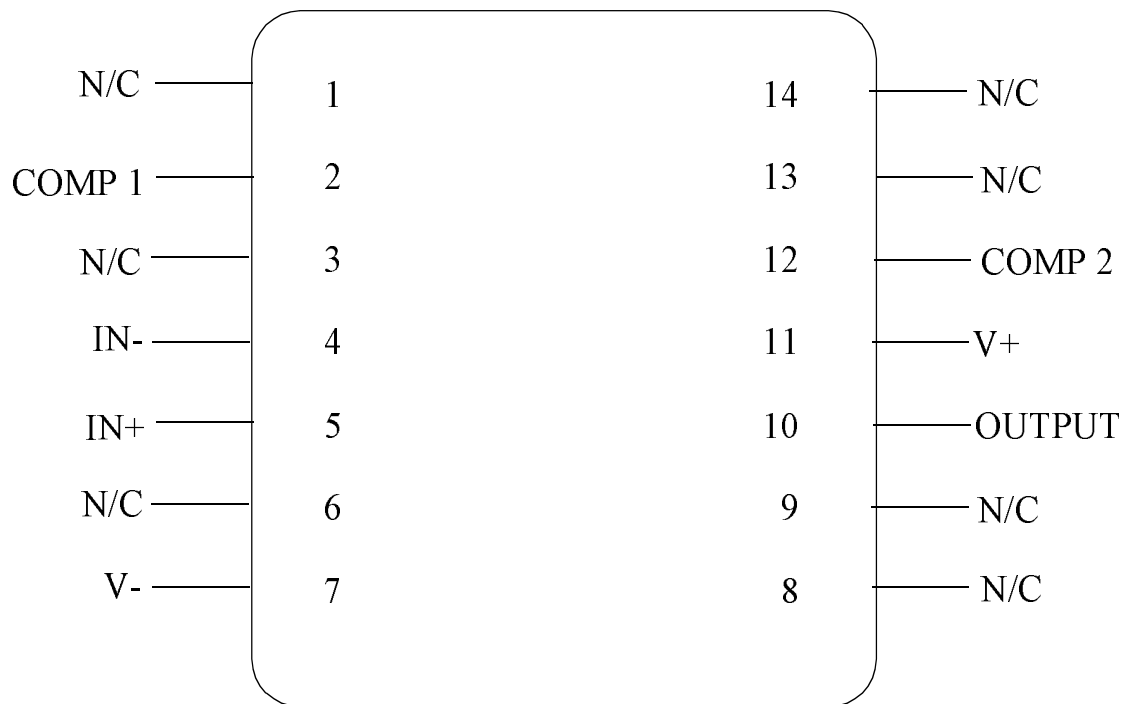

LM108AJ, LM108J
14 - LEAD DIP
CONNECTION DIAGRAM
TOP VIEW
P000311A



National Semiconductor™
 MIL/AEROSPACE OPERATIONS
 2900 SEMICONDUCTOR DRIVE
 SANTA CLARA, CA 95050

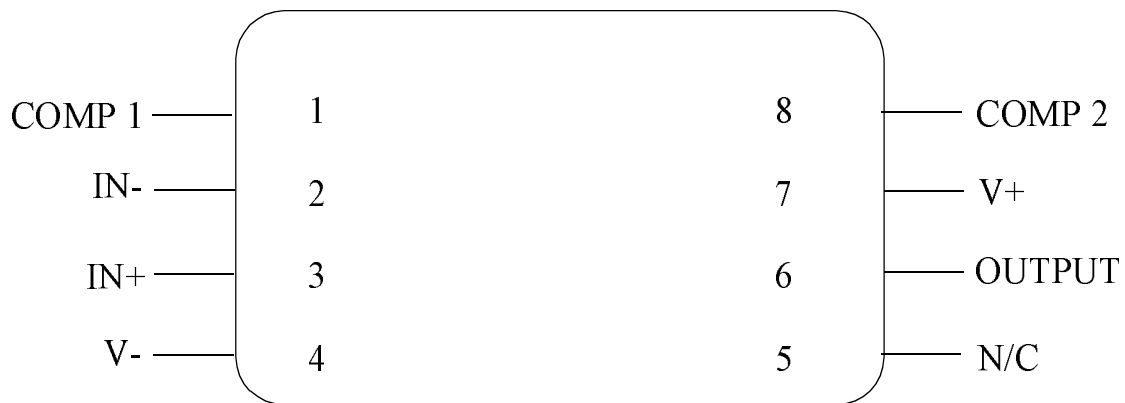

LM108AJ-8, LM108J-8

8 - LEAD DIP

CONNECTION DIAGRAM

TOP VIEW

P000312A



National Semiconductor™

MIL/AEROSPACE OPERATIONS
2900 SEMICONDUCTOR DRIVE
SANTA CLARA, CA 95050

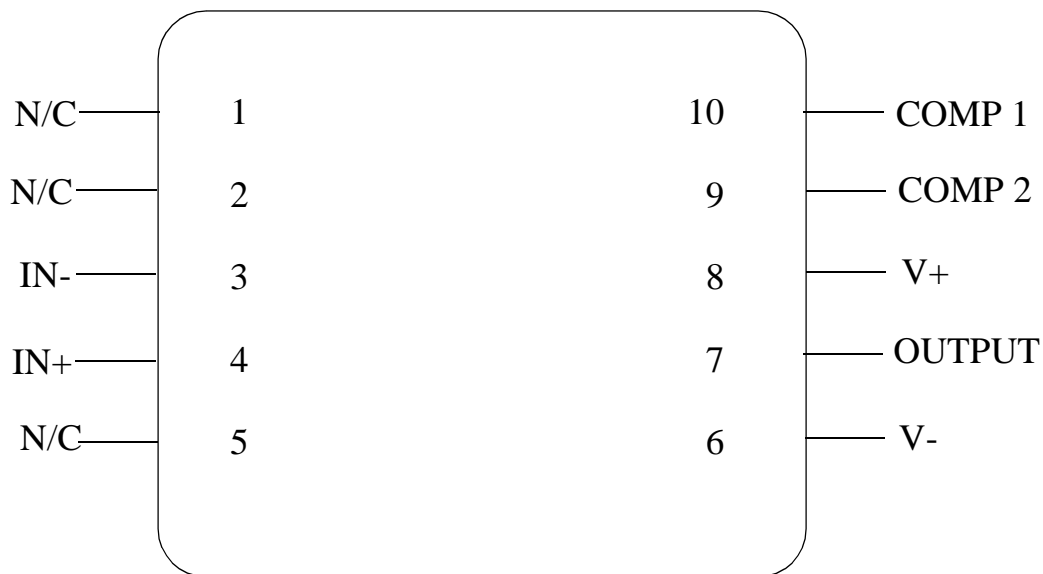

LM108AW
10 - LEAD CERPACK
CONNECTION DIAGRAM
TOP VIEW
P000431A



National Semiconductor™
MIL/AEROSPACE OPERATIONS
2900 SEMICONDUCTOR DRIVE
SANTA CLARA, CA 95050

REVISIONS			
LTR	DESCRIPTION	E.C.N.	DATE
F	REVISE AND REDRAW PER NEW STANDARD.	10510	07/28/94 DEG/AEP
G	.017±.002 WAS .017±.020.	10654	10/21/94 DEG/

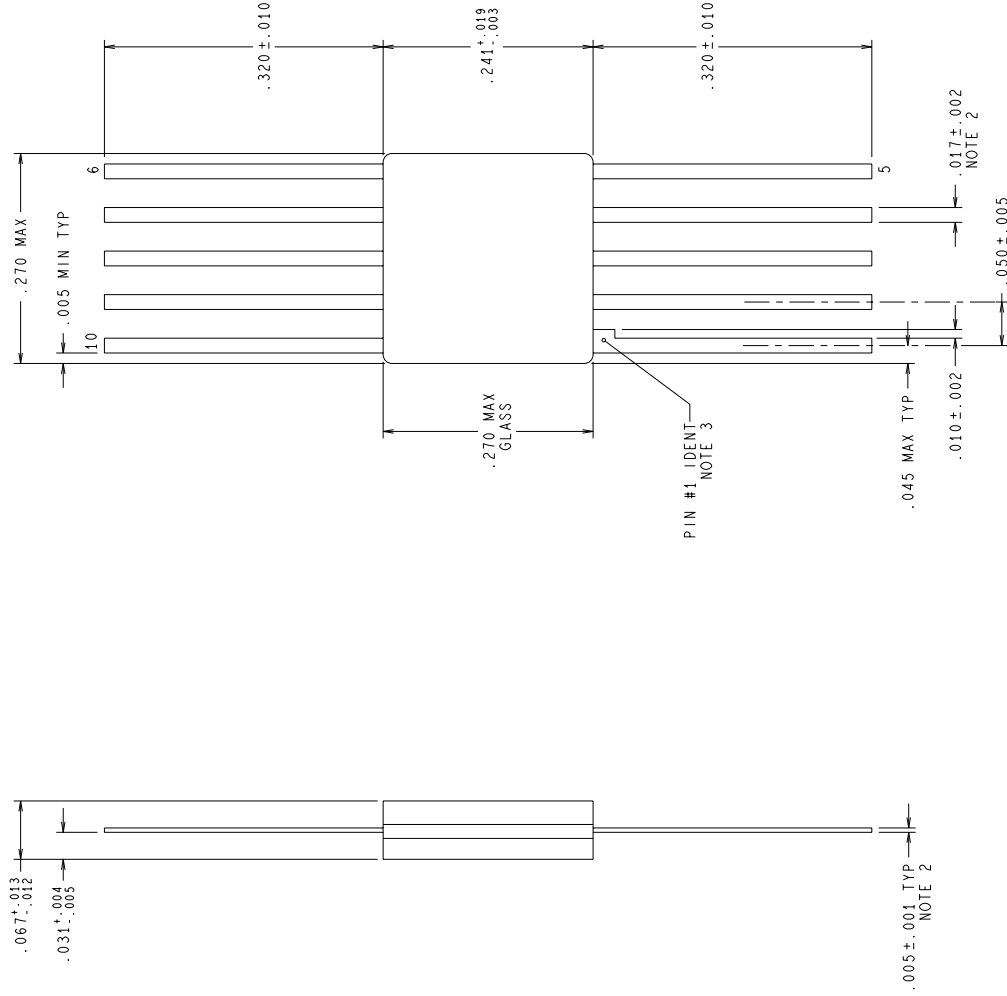

NOTES: UNLESS OTHERWISE SPECIFIED.

1. LEAD FINISH: SOLDER DIPPED WITH Sn60 OR Sn63 SOLDER CONFORMING TO MIL-M-38510 TO A MINIMUM THICKNESS OF 200 MICROINCHES. SOLDER MAY BE APPLIED OVER LEAD BASIS METAL OR Sn PLATE.
2. MAXIMUM LIMIT MAY BE INCREASED BY .003 INCHES AFTER LEAD FINISH APPLIED.
3. LEAD 1 IDENTIFICATION SHALL BE:
 - a) A NOTCH OR OTHER MARK WITHIN THIS AREA
 - b) A TAB ON LEAD 1, EITHER SIDE
4. REFERENCE JEDEC REGISTRATION M0-003, VARIATION AG, DATED 06/01/76.

MIL/AERO
CONFIGURATION CONTROL

MIL-M-38510
CONFIGURATION CONTROL

APPROVALS		DATE	
DRWN	<i>D. F. Grady</i>		07/28/94
DTG. CHK.			
ENGR. CHK.			

PROJECTION			

National Semiconductor			
2800 Semiconductor dr., Santa Clara, CA 95052-8090			
SCALE	SIZE	DRAWING NUMBER	REV
N/A	C	MKT-W10A	G
DO NOT SCALE DRAWING			SHEET 1 of 1

REVISIONS

LTR	DESCRIPTION	E.C.N.	DATE	BY/APP'D
A	RELEASE TO DOCUMENT CONTROL	11374	02/29/1996	MS/KH
B	LD PITCH TOL WAS ±.005; CHANGE LD RADIUS TO REF DIM; REMOVE THE OTHER R.006±.002 DIM. .040±.003 WAS .037±.003	11441	04/19/1996	MS/KH
C	R .015(0.38) WAS R .006(0.15)	11838	10/08/1997	TL/

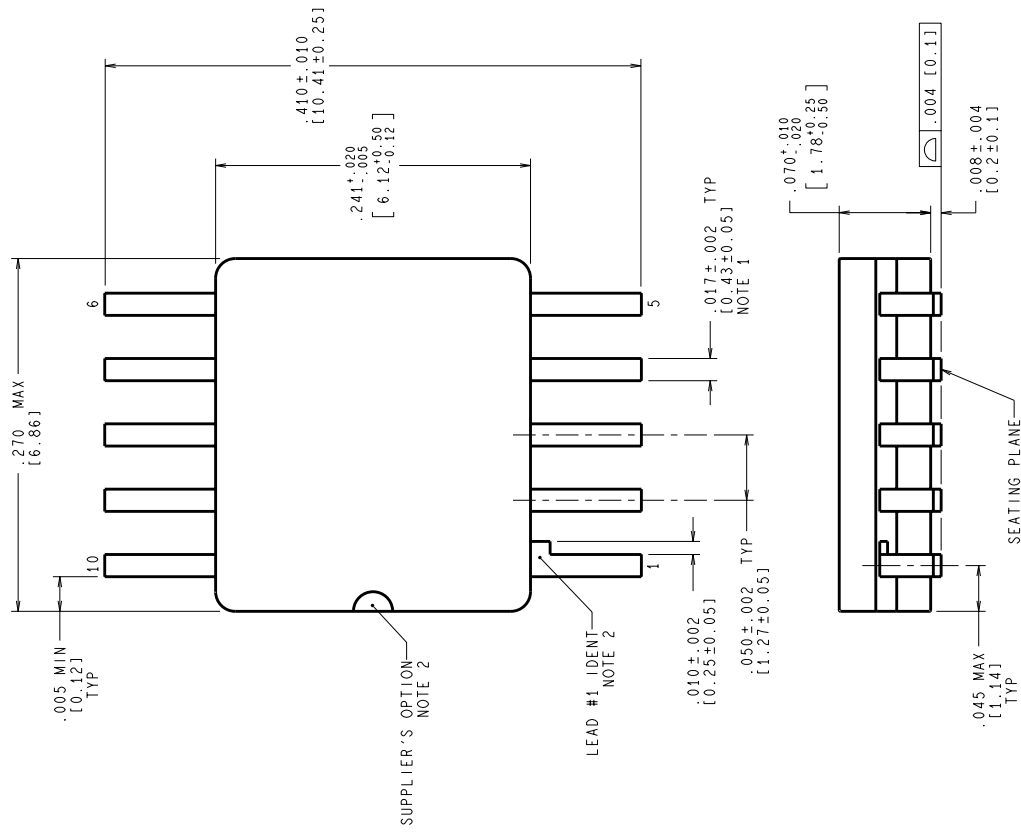

CONTROLLING DIMENSION IS INCH
VALUES IN | ARE MILLIMETERS

MIL-PRF-38535
CONFIGURATION CONTROL

APPROVALS	DATE	SCALE	SIZE	DRAWING NUMBER	REV
DRN: MARYA SUCHY	02/29/96	N/A	C	(SC)MKT-WG10A	C
DATE: 02/29/96					
CHK: [Signature]					
CHK: [Signature]					
PROJECTION					
National Semiconductor 2800 Semiconductor Dr., Santa Clara, CA 95052-8090					
CERPACK, 10 LEAD, GULL WING					
DO NOT SCALE DRAWING					
SHEET 1 of 1					

- NOTES: UNLESS OTHERWISE SPECIFIED
- LEAD FINISH: SOLDER DIPPED WITH Sn60 OR Sn63 SOLDER CONFORMING TO MIL-PRF-38535 TO A MINIMUM THICKNESS OF 200 MICRONS/ 5.08 MICROMETERS. SOLDER MAY BE APPLIED OVER LEAD BASIS METAL OR Sn PLATE. MAXIMUM LIMIT MAY BE INCREASED BY .003 IN/ 0.08mm AFTER LEAD FINISH APPLIED.
 - LEAD 1 IDENTIFICATION SHALL BE:
 - A NOTCH OR OTHER MARK WITHIN THIS AREA
 - A TAB ON LEAD 1, EITHER SIDE
 - NO JEDEC REGISTRATION AS OF FEBRUARY 1996.

Revision History

Rev	ECN #	Rel Date	Originator	Changes
1A0	M0003283	04/16/99	Rose Malone	Update MDS: MJLM108A-X, Rev. 0B1 to Fully Release MDS MJLM108A-X, Rev. 1A0.
2A0	M0003363	04/16/99	Rose Malone	Update MDS: MJLM108A-X, Rev. 1A0 to MJLM108A-X, Rev. 2A0. Update Thermal Resistance - Cerpack (Still Air) from 150 C/W to 225 C/W, Electricals: DC and Drift Values Section - Removed reference to Rs=5 Mohms from Iio, +Iib, -Iib. Correction made to correlate with test program.