

## ADC10D040

### Dual 10-Bit, 40 MSPS, 267 mW A/D Converter

#### General Description

The ADC10D040 is a dual low power, high performance CMOS analog-to-digital converter that digitizes signals to 10 bits resolution at sampling rates up to 45 MSPS while consuming a typical 267 mW from a single 3.3V supply. No missing codes is guaranteed over the full operating temperature range. The unique two stage architecture achieves 9.4 Effective Bits over the entire Nyquist band at 40 MHz sample rate. An output formatting choice of straight binary or 2's complement coding and a choice of two gain settings eases the interface to many systems. Also allowing great flexibility of use is a selectable 10-bit multiplexed or 20-bit parallel output mode. An offset correction feature minimizes the offset error.

To ease interfacing to most low voltage systems, the digital output power pins of the ADC10D040 can be tied to a separate supply voltage of 1.5V to 3.6V, making the outputs compatible with other low voltage systems. When not converting, power consumption can be reduced by pulling the PD (Power Down) pin high, placing the converter into a low power state where it typically consumes less than 1 mW and from which recovery is less than 1 ms. Bringing the STBY (Standby) pin high places the converter into a standby mode where power consumption is about 30 mW and from which recovery is 800 ns.

The ADC10D040's speed, resolution and single supply operation make it well suited for a variety of applications, including high speed portable applications.

Operating over the industrial ( $-40^{\circ} \leq T_A \leq +85^{\circ}\text{C}$ ) temperature range, the ADC10D040 is available in a 48-pin TQFP. An evaluation board is available to ease the design effort.

#### Features

- Internal sample-and-hold
- Internal Reference Capability
- Dual gain settings
- Offset correction
- Selectable straight binary or 2's complement output
- Multiplexed or parallel output bus
- Single +3.0V to 3.6V operation
- Power down and standby modes
- 3V TTL Logic input/output compatible

#### Key Specifications

■ Resolution	10 Bits
■ Conversion Rate	40 MSPS
■ ENOB	9.4 Bits (typ)
■ DNL	0.35 LSB (typ)
■ Conversion Latency Parallel Outputs	2.5 Clock Cycles
— Multiplexed Outputs, I Data Bus	2.5 Clock Cycles
— Multiplexed Outputs, Q Data Bus	3 Clock Cycles
■ PSRR	90 dB
■ Power Consumption—Normal Operation	267 mW (typ)
— Power Down Mode	< 1 mW (typ)
— Fast Recovery Standby Mode	30 mW (typ)

#### Applications

- Digital Video
- CCD Imaging
- Portable Instrumentation
- Communications
- Medical Imaging
- Ultrasound

## Connection Diagram

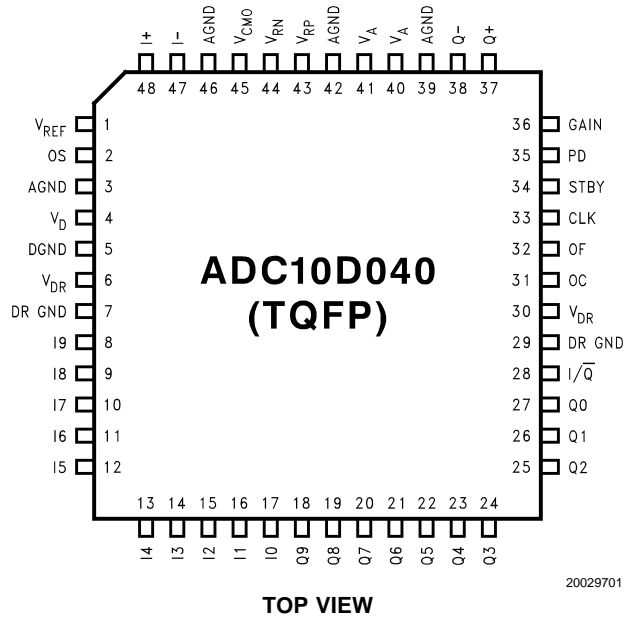

## Ordering Information

Industrial Temperature Range ( $-40^{\circ}\text{C} \leq T_A \leq +85^{\circ}\text{C}$ )	NS Package
ADC10D040CIVS	TQFP
ADC10D040EVAL	Evaluation Board

### Block Diagram

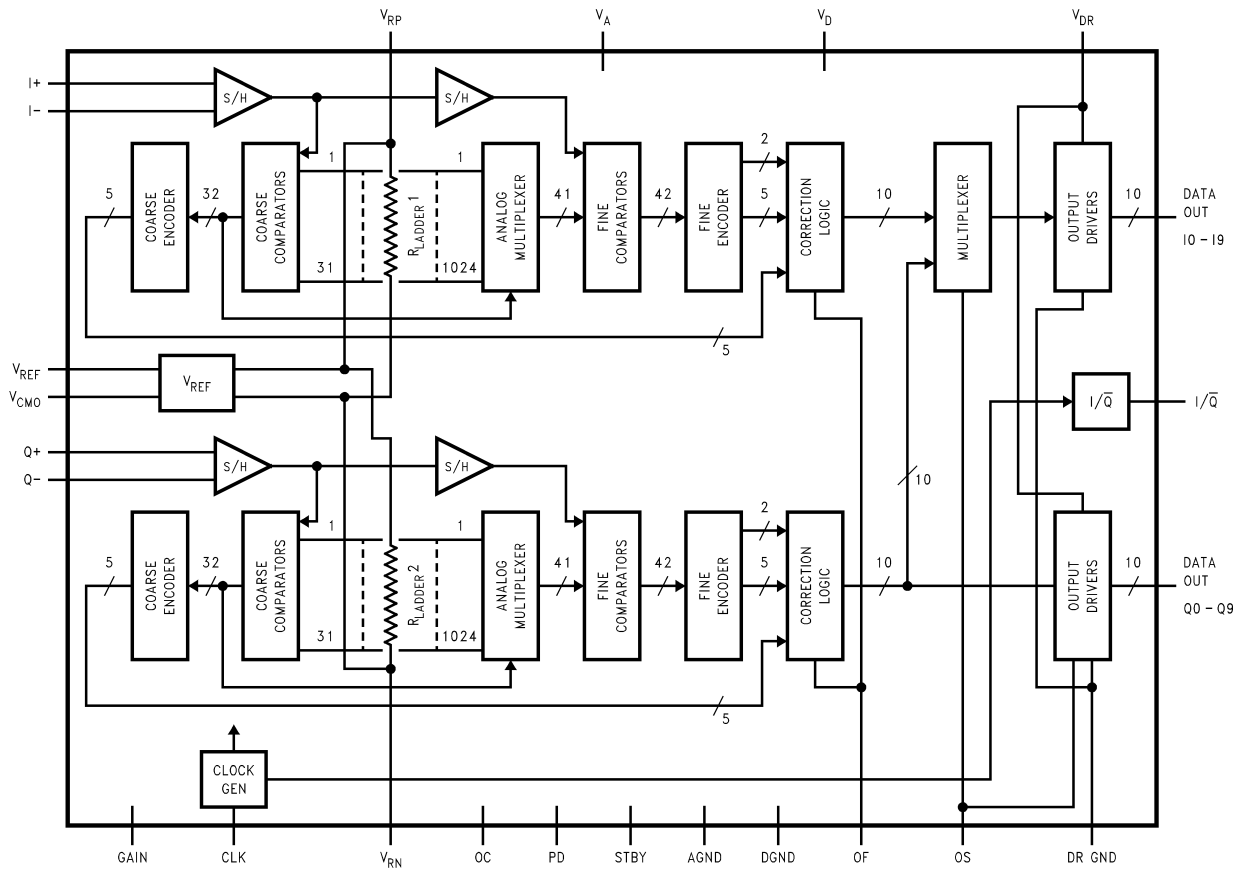

20029702

### Pin Descriptions and Equivalent Circuits

Pin No.	Symbol	Equivalent Circuit	Description
48 47	I+ I-		Analog inputs to "I" ADC. With $V_{REF} = 1.4V$ , conversion range is 1.15V to 1.85V with GAIN pin low, or 0.8V to 2.2V with GAIN pin high.
37 38	Q+ Q-		Analog inputs to "Q" ADC. With $V_{REF} = 1.4V$ , conversion range is 1.15V to 1.85V with GAIN pin low, or 0.8V to 2.2V with GAIN pin high.
1	$V_{REF}$		Analog Reference Voltage input. The voltage at this pin should be in the range of 0.6V to 1.6V. With 1.4V at this pin and the GAIN pin <i>low</i> , the full scale differential inputs are 1.4 $V_{P-P}$ . With 1.4V at this pin and the GAIN pin <i>high</i> , the full scale differential inputs are 2.8 $V_{P-P}$ . This pin should be bypassed with a minimum 1 $\mu F$ capacitor.

## Pin Descriptions and Equivalent Circuits (Continued)

Pin No.	Symbol	Equivalent Circuit	Description
45	$V_{CMO}$		<p>This is an analog output which can be used as a reference source and/or to set the common mode voltage of the input. It should be bypassed with a minimum of 1 <math>\mu\text{F}</math> low ESR capacitor in parallel with a 0.1 <math>\mu\text{F}</math> capacitor. This pin has a nominal output voltage of 1.5V and has a 1 mA output source capability.</p>
43	$V_{RP}$		<p>Top of the reference ladder. <b>Do not drive this pin.</b> Bypass this pin with a 10 <math>\mu\text{F}</math> low ESR capacitor and a 0.1 <math>\mu\text{F}</math> capacitor.</p>
44	$V_{RN}$		<p>Bottom of the reference ladder. <b>Do not drive this pin.</b> Bypass this pin with a 10 <math>\mu\text{F}</math> low ESR capacitor and a 0.1 <math>\mu\text{F}</math> capacitor.</p>

## Pin Descriptions and Equivalent Circuits (Continued)

Pin No.	Symbol	Equivalent Circuit	Description
33	CLK		Digital clock input for both converters. The analog inputs are sampled on the falling edge of this clock input.
2	OS		Output Bus Select. With this pin at a logic high, both the "I" and the "Q" data are present on their respective 10-bit output buses (Parallel mode of operation). When this pin is at a logic low, the "I" and "Q" data are multiplexed onto the "I" output bus and the "Q" output lines all remain at a logic low (multiplexed mode).
31	OC		Offset Correct pin. A low-to-high transition on this pin initiates an independent offset correction sequence for each converter, which takes 34 clock cycles to complete. During this time 32 conversions are taken and averaged. The result is subtracted from subsequent conversions. Each input pair should have 0V differential value during this entire 34 clock period.
32	OF		Output Format pin. When this pin is LOW the output format is Straight Binary. When this pin is HIGH the output format is 2's complement. This pin may be changed asynchronously, but this will result in errors for one or two conversions.
34	STBY		Standby pin. The device operates normally with a logic low on this and the PD (Power Down) pin. With this pin at a logic high and the PD pin at a logic low, the device is in the standby mode where it consumes just 30 mW of power. It takes just 800 ns to come out of this mode after the STBY pin is brought low.
35	PD		Power Down pin that, when high, puts the converter into the Power Down mode where it consumes just 1 mW of power. It takes less than 1 ms to recover from this mode after the PD pin is brought low. If both the STBY and PD pins are high simultaneously, the PD pin dominates.
36	GAIN		This pin sets the internal signal gain at the inputs to the ADCs. With this pin low the full scale differential input peak-to-peak signal is equal to $V_{REF}$ . With this pin high the full scale differential input peak-to-peak signal is equal to $2 \times V_{REF}$ .
8 thru 27	I0–I9 and Q0–Q9		3V TTL/CMOS-compatible Digital Output pins that provide the conversion results of the I and Q inputs. I0 and Q0 are the LSBs, I9 and Q9 are the MSBs. Valid data is present just after the rising edge of the CLK input in the Parallel mode. In the multiplex mode, I-channel data is valid on I0 through I9 when the $I/\bar{Q}$ output is high and the Q-channel data is valid on I0 through I9 when the $I/\bar{Q}$ output is low.
28	$I/\bar{Q}$		Output data valid signal. In the multiplexed mode, this pin transitions from low to high when the data bus transitions from Q-data to I-data, and from high to low when the data bus transitions from I-data to Q-data. In the Parallel mode, this pin transitions from low to high as the output data changes.
40, 41	$V_A$		Positive analog supply pin. This pin should be connected to a quiet voltage source of +3.0V to +3.6V. $V_A$ and $V_D$ should have a common supply and be separately bypassed with 10 $\mu$ F to 50 $\mu$ F capacitors in parallel with 0.1 $\mu$ F capacitors.

## Pin Descriptions and Equivalent Circuits (Continued)

Pin No.	Symbol	Equivalent Circuit	Description
4	$V_D$		Digital supply pin. This pin should be connected to a quiet voltage source of +3.0V to +3.6V. $V_A$ and $V_D$ should have a common supply and be separately bypassed with 10 $\mu$ F to 50 $\mu$ F capacitors in parallel with 0.1 $\mu$ F capacitors.
6, 30	$V_{DR}$		Digital output driver supply pins. These pins should be connected to a voltage source of +1.5V to $V_D$ and be bypassed with 10 $\mu$ F to 50 $\mu$ F capacitors in parallel with 0.1 $\mu$ F capacitors.
3, 39, 42, 46	AGND		The ground return for the analog supply. AGND and DGND should be connected together close to the ADC10D040 package.
5	DGND		The ground return for the digital supply. AGND and DGND should be connected together close to the ADC10D040 package.
7, 29	DR GND		The ground return of the digital output drivers.

## Absolute Maximum Ratings (Notes 1,

2)

**If Military/Aerospace specified devices are required, please contact the National Semiconductor Sales Office/ Distributors for availability and specifications.**

Positive Supply Voltages	3.8V
Voltage on Any Pin	-0.3V to (V <sub>A</sub> or V <sub>D</sub> +0.3V)
Input Current at Any Pin (Note 3)	±25 mA
Package Input Current (Note 3)	±50 mA
Package Dissipation at T <sub>A</sub> = 25°C	See (Note 4)
ESD Susceptibility (Note 5)	
Human Body Model	2500V
Machine Model	250V
Soldering Temperature,	
Infrared, 10 sec. (Note 6)	235°C
Storage Temperature	-65°C to +150°C

## Operating Ratings (Notes 1, 2)

Operating Temperature Range	-40°C ≤ T <sub>A</sub> ≤ +85°C	
V <sub>A</sub> , V <sub>D</sub> Supply Voltage	+3.0V to +3.6V	
V <sub>DR</sub> Supply Voltage	+1.5V to V <sub>D</sub>	
V <sub>IN</sub> Differential Voltage Range		
GAIN = Low	±V <sub>REF</sub> /2	
GAIN = High	±V <sub>REF</sub>	
V <sub>CM</sub> Input Common Mode Range		
GAIN = Low	V <sub>REF</sub> /4 to (V <sub>A</sub> -V <sub>REF</sub> /4)	
GAIN = High	V <sub>REF</sub> /2 to (V <sub>A</sub> -V <sub>REF</sub> /2)	
V <sub>REF</sub> Voltage Range	0.6V to 1.8V	
Digital Input Pins Voltage		
Range	-0.3V to (V <sub>A</sub> +0.3V)	

## Converter Electrical Characteristics

The following specifications apply for V<sub>A</sub> = V<sub>D</sub> = +3.3 V<sub>DC</sub>, V<sub>DR</sub> = +2.5 V<sub>DC</sub>, V<sub>REF</sub> = 1.4 V<sub>DC</sub>, GAIN = OF = 0V, OS = 3.3V, V<sub>IN</sub> (ac coupled) = FSR = 1.4 V<sub>P-P</sub>, C<sub>L</sub> = 15 pF, f<sub>CLK</sub> = 40 MHz, 50% Duty Cycle, R<sub>S</sub> = 50Ω, t<sub>rc</sub> = t<sub>fc</sub> < 4 ns, NOT offset corrected. **Boldface limits apply for T<sub>A</sub> = T<sub>MIN</sub> to T<sub>MAX</sub>**; all other limits T<sub>A</sub> = 25°C (Note 7).

Symbol	Parameter	Conditions	Typical (Note 8)	Limits (Note 9)	Units (Limits)
<b>STATIC CONVERTER CHARACTERISTICS</b>					
INL	Integral Non-Linearity		±0.65	<b>±1.9</b>	LSB(max)
DNL	Differential Non-Linearity		±0.35	<b>+1.2</b> <b>-1.0</b>	LSB(max) LSB(min)
	Resolution with No Missing Codes			<b>10</b>	Bits
V <sub>OFF</sub>	Offset Error	Without Offset Correction	-3.3	<b>+7</b> <b>-12</b>	LSB(max) LSB(min)
		With Offset Correction	+0.4	<b>+1.5</b> <b>-0.5</b>	LSB(max) LSB(min)
GE	Gain Error		-4	<b>+5</b> <b>-12</b>	%FS(max) %FS(min)
<b>DYNAMIC CONVERTER CHARACTERISTICS</b>					
ENOB	Effective Number of Bits	f <sub>IN</sub> = 4.43 MHz, V <sub>IN</sub> = FSR -0.1 dB	9.5		Bits
		f <sub>IN</sub> = 10.4 MHz, V <sub>IN</sub> = FSR -0.1 dB, T <sub>A</sub> = 25°C	9.5	9.1	Bits(min)
		f <sub>IN</sub> = 19.7 MHz, V <sub>IN</sub> = FSR -0.1 dB	9.4		Bits
SINAD	Signal-to-Noise Plus Distortion Ratio	f <sub>IN</sub> = 4.43 MHz, V <sub>IN</sub> = FSR -0.1 dB	59		dB
		f <sub>IN</sub> = 10.4 MHz, V <sub>IN</sub> = FSR -0.1 dB, T <sub>A</sub> = 25°C	59	56.3	dB(min)
		f <sub>IN</sub> = 19.7 MHz, V <sub>IN</sub> = FSR -0.1 dB	58		dB
SNR	Signal-to-Noise Ratio	f <sub>IN</sub> = 4.43 MHz, V <sub>IN</sub> = FSR -0.1 dB	60		dB
		f <sub>IN</sub> = 10.4 MHz, V <sub>IN</sub> = FSR -0.1 dB, T <sub>A</sub> = 25°C	60	57.3	dB(min)
		f <sub>IN</sub> = 19.7 MHz, V <sub>IN</sub> = FSR -0.1 dB	59		dB
THD	Total Harmonic Distortion	f <sub>IN</sub> = 4.43 MHz, V <sub>IN</sub> = FSR -0.1 dB	-70		dB
		f <sub>IN</sub> = 10.4 MHz, V <sub>IN</sub> = FSR -0.1 dB, T <sub>A</sub> = 25°C	-69	-61	dB(min)
		f <sub>IN</sub> = 19.7 MHz, V <sub>IN</sub> = FSR -0.1 dB	-67		dB
HS2	Second Harmonic	f <sub>IN</sub> = 4.43 MHz, V <sub>IN</sub> = FSR -0.1 dB	-86		dB
		f <sub>IN</sub> = 10.4 MHz, V <sub>IN</sub> = FSR -0.1 dB	-83		dB
		f <sub>IN</sub> = 19.7 MHz, V <sub>IN</sub> = FSR -0.1 dB	-81		dB
HS3	Third Harmonic	f <sub>IN</sub> = 4.43 MHz, V <sub>IN</sub> = FSR -0.1 dB	-73		dB
		f <sub>IN</sub> = 10.4 MHz, V <sub>IN</sub> = FSR -0.1 dB	-73		dB
		f <sub>IN</sub> = 19.7 MHz, V <sub>IN</sub> = FSR -0.1 dB	-72		dB

## Converter Electrical Characteristics (Continued)

The following specifications apply for  $V_A = V_D = +3.3 V_{DC}$ ,  $V_{DR} = +2.5 V_{DC}$ ,  $V_{REF} = 1.4 V_{DC}$ ,  $GAIN = OF = 0V$ ,  $OS = 3.3V$ ,  $V_{IN}$  (ac coupled) =  $FSR = 1.4 V_{P-P}$ ,  $C_L = 15 pF$ ,  $f_{CLK} = 40 MHz$ , 50% Duty Cycle,  $R_S = 50\Omega$ ,  $t_{rc} = t_{fc} < 4 ns$ , NOT offset corrected. **Boldface limits apply for  $T_A = T_{MIN}$  to  $T_{MAX}$** : all other limits  $T_A = 25^\circ C$  (Note 7).

Symbol	Parameter	Conditions	Typical (Note 8)	Limits (Note 9)	Units (Limits)
SFDR	Spurious Free Dynamic Range	$f_{IN} = 4.43 MHz$ , $V_{IN} = FSR - 0.1 dB$	72		dB
		$f_{IN} = 10.4 MHz$ , $V_{IN} = FSR - 0.1 dB$	72		dB
		$f_{IN} = 19.7 MHz$ , $V_{IN} = FSR - 0.1 dB$	70		dB
IMD	Intermodulation Distortion	$f_{IN1} < 8.5 MHz$ , $V_{IN} = FSR - 6.1 dB$	71		dB
		$f_{IN2} < 9.5 MHz$ , $V_{IN} = FSR - 6.1 dB$			
		Overrange Output Code ( $V_{IN+} - V_{IN-}$ ) $> 1.5V$			
	Underrange Output Code ( $V_{IN+} - V_{IN-}$ ) $< -1.5V$			<b>0</b>	
FPBW	Full Power Bandwidth		140		MHz
INTER-CHANNEL CHARACTERISTICS					
	Crosstalk	1 MHz input to tested channel, 10.3 MHz input to other channel	-72		dB
	Channel - Channel Aperture Delay Match	$f_{IN} = 8 MHz$	8.5		ps
	Channel - Channel Gain Matching		0.1		%FS
REFERENCE AND ANALOG CHARACTERISTICS					
$V_{IN}$	Analog Differential Input Range	Gain Pin = AGND	1.4		$V_{P-P}$
		Gain Pin = $V_A$	2.8		$V_{P-P}$
$C_{IN}$	Analog Input Capacitance (each input)	Clock High	6		pF
		Clock Low	3		pF
$R_{IN}$	Analog Differential Input Resistance		13.5		k $\Omega$
$V_{REF}$	Reference Voltage		1.4	0.6	V(min)
				1.6	V(max)
$I_{REF}$	Reference Input Current		<1		$\mu A$
$V_{CMO}$	Common Mode Voltage Output	1 mA load to ground (sourcing current)	1.5	<b>1.35</b>	V(min)
				<b>1.6</b>	V(max)
TC	Common Mode Voltage Temperature Coefficient		30		ppm/ $^\circ C$
DIGITAL INPUT CHARACTERISTICS					
$V_{IH}$	Logical "1" Input Voltage	$V_D = +3.0V$		<b>2.0</b>	V(min)
$V_{IL}$	Logical "0" Input Voltage	$V_D = +3.6V$		<b>0.5</b>	V(max)
$I_{IH}$	Logical "1" Input Current	$V_{IH} = V_D$	<1		$\mu A$
$I_{IL}$	Logical "0" Input Current	$V_{IL} = DGND$	>-1		$\mu A$
DIGITAL OUTPUT CHARACTERISTICS					
$V_{OH}$	Logical "1" Output Voltage	$V_{DR} = +2.5V$ , $I_{OUT} = -0.5 mA$		<b><math>V_{DR} - 0.2V</math></b>	V(min)
$V_{OL}$	Logical "0" Output Voltage	$V_{DR} = +2.5V$ , $I_{OUT} = 1.6 mA$		<b>0.4</b>	V(max)
$+I_{SC}$	Output Short Circuit Source Current	$V_{OUT} = 0V$	Parallel Mode	-4.7	mA
			Multiplexed Mode	-9	mA
$-I_{SC}$	Output Short Circuit Sink Current	$V_{OUT} = V_{DR}$	Parallel Mode	4.7	mA
			Multiplexed Mode	9	mA
POWER SUPPLY CHARACTERISTICS					
$I_A$	Analog Supply Current	PD = LOW, STBY = LOW, dc input	70	<b>80</b>	mA(max)
		PD = LOW, STBY = HIGH	10		mA
		PD = HIGH, STBY = LOW or HIGH	0.1		mA

### Converter Electrical Characteristics (Continued)

The following specifications apply for  $V_A = V_D = +3.3 V_{DC}$ ,  $V_{DR} = +2.5 V_{DC}$ ,  $V_{REF} = 1.4 V_{DC}$ ,  $GAIN = OF = 0V$ ,  $OS = 3.3V$ ,  $V_{IN}$  (ac coupled) =  $FSR = 1.4 V_{P-P}$ ,  $C_L = 15 pF$ ,  $f_{CLK} = 40 MHz$ , 50% Duty Cycle,  $R_S = 50\Omega$ ,  $t_{rc} = t_{fc} < 4 ns$ , NOT offset corrected. **Boldface limits apply for  $T_A = T_{MIN}$  to  $T_{MAX}$** : all other limits  $T_A = 25^\circ C$  (Note 7).

Symbol	Parameter	Conditions	Typical (Note 8)	Limits (Note 9)	Units (Limits)
$I_D$	Digital Supply Current	PD = LOW, STBY = LOW, dc input	9	<b>10</b>	mA(max)
		PD = LOW, STBY = HIGH	0.1		mA
		PD = HIGH, STBY = LOW or HIGH	0.1		mA
$I_{DR}$	Digital Output Driver Supply Current (Note 10)	PD = STBY = LOW, dc input	1.9	<b>2.5</b>	mA(max)
PD	Power Consumption	PD = LOW, STBY = LOW, dc input	267	<b>305</b>	mW(max)
		PD = LOW, STBY = LOW, 1 MHz Input	270		mW
		PD = LOW, STBY = HIGH	30		mW
		PD = HIGH, STBY = LOW or HIGH	0.6		mW
PSRR1	Power Supply Rejection Ratio	Change in Full Scale with 3.0V to 3.6V Supply Change	90		dB
PSRR2	Power Supply Rejection Ratio	Rejection at output with 10.3 MHz, 250 mV <sub>P-P</sub> Riding on $V_A$ and $V_D$	52		dB

### AC Electrical Characteristics OS = Low (Multiplexed Mode)

The following specifications apply for  $V_A = V_D = +3.3 V_{DC}$ ,  $V_{DR} = +2.5V_{DC}$ ,  $V_{REF} = 1.4 V_{DC}$ ,  $GAIN = OF = 0V$ ,  $OS = 0V$ ,  $V_{IN}$  (ac coupled) =  $FSR = 1.4 V_{P-P}$ ,  $C_L = 15 pF$ ,  $f_{CLK} = 40 MHz$ , 50% Duty Cycle,  $R_S = 50\Omega$ ,  $t_{rc} = t_{fc} < 4 ns$ , NOT offset corrected. **Boldface limits apply for  $T_A = T_{MIN}$  to  $T_{MAX}$** : all other limits  $T_A = 25^\circ C$  (Note 7)

Symbol	Parameter	Conditions	Typical (Note 8)	Limits (Note 9)	Units (Limits)
$f_{CLK}^1$	Maximum Clock Frequency		45	<b>40</b>	MHz(min)
$f_{CLK}^2$	Minimum Clock Frequency		1		MHz
	Duty Cycle		50	<b>45</b> <b>55</b>	%(min) %(max)
	Pipeline Delay (Latency)				
	I Data			<b>2.5</b>	Clock Cycles
	Q Data			<b>3.0</b>	Clock Cycles
$t_r, t_f$	Output Rise and Fall Times		5		ns
$t_{OC}$	Offset Correction Pulse Width			<b>10</b>	ns(min)
$t_{OD}$	Output Delay from CLK Edge to Data Valid		13	<b>19</b>	ns(max)
$t_{DIQ}$	I/Q Output Delay		13		ns
$t_{SKEW}$	I/Q to Data Skew		$\pm 200$		ps
$t_{AD}$	Sampling (Aperture) Delay		2.2		ns
$t_{AJ}$	Aperture Jitter		<10		ps(rms)
$t_{VALID}$	Data Valid Time		7.5		ns
	Overrange Recovery Time	Differential $V_{IN}$ step from 1.5V to 0V	50		ns
$t_{WUPD}$	PD Low to 1/2 LSB Accurate Conversion (Wake-Up Time)		<1		ms
$t_{WUSB}$	STBY Low to 1/2 LSB Accurate Conversion (Wake-Up Time)		800		ns

## AC Electrical Characteristics OS = High (Parallel Mode)

The following specifications apply for  $V_A = V_D = +3.3 V_{DC}$ ,  $V_{DR} = +2.5V_{DC}$ ,  $V_{REF} = 1.4 V_{DC}$ ,  $GAIN = OF = 0V$ ,  $OS = +3.3V$ ,  $V_{IN}$  (ac coupled) =  $FSR = 1.0 V_{P-P}$ ,  $C_L = 15 pF$ ,  $f_{CLK} = 40 MHz$ , 50% Duty Cycle,  $R_S = 50\Omega$ ,  $t_{rc} = t_{fc} < 4 ns$ , NOT offset corrected. **Boldface limits apply for  $T_A = T_{MIN}$  to  $T_{MAX}$** : all other limits  $T_A = 25^\circ C$  (Note 7)

Symbol	Parameter	Conditions	Typical (Note 8)	Limits (Note 9)	Units (Limits)
$f_{CLK1}$	Maximum Clock Frequency		45	<b>40</b>	MHz(min)
$f_{CLK2}$	Minimum Clock Frequency		1		MHz
	Duty Cycle		50	<b>45</b> <b>55</b>	%(min) %(max)
	Pipeline Delay (Latency)			<b>2.5</b>	Clock Cycles
$t_r, t_f$	Output Rise and Fall Times		9		ns
$t_{oc}$	OC Pulse Width			<b>10</b>	ns
$t_{OD}$	Output Delay from CLK Edge to Data Valid		16	<b>22</b>	ns(max)
$t_{DIQ}$	I/Q Output Delay		13		ns
$t_{AD}$	Sampling (Aperture) Delay		2.2		ns
$t_{AJ}$	Aperture Jitter		<10		ps(rms)
$t_{VALID}$	Data Valid Time		16		ns
	Overrange Recovery Time	Differential $V_{IN}$ step from 1.5V to 0V	50		ns
$t_{WUPD}$	PD Low to 1/2 LSB Accurate Conversion (Wake-Up Time)		< 1		ms
$t_{WUSB}$	STBY Low to 1/2 LSB Accurate Conversion (Wake-Up Time)		800		ns

**Note 1:** Absolute Maximum Ratings indicate limits beyond which damage to the device may occur. Operating Ratings indicate conditions for which the device is functional, but do not guarantee specific performance limits. For guaranteed specifications and test conditions, see the Electrical Characteristics. The guaranteed specifications apply only for the test conditions listed. Some performance characteristics may degrade when the device is not operated under the listed test conditions.

**Note 2:** All voltages are measured with respect to GND = AGND = DGND = 0V, unless otherwise specified.

**Note 3:** When the input voltage at any pin exceeds the power supplies ( $V_{IN} < GND$  or  $V_{IN} > V_A$  or  $V_D$ ), the current at that pin should be limited to 25 mA. The 50 mA maximum package input current rating limits the number of pins that can safely exceed the power supplies with an input current of 25 mA to two.

**Note 4:** The absolute maximum junction temperature ( $T_{Jmax}$ ) for this device is  $150^\circ C$ . The maximum allowable power dissipation is dictated by  $T_{Jmax}$ , the junction-to-ambient thermal resistance ( $\theta_{JA}$ ), and the ambient temperature ( $T_A$ ), and can be calculated using the formula  $P_{DMAX} = (T_{Jmax} - T_A) / \theta_{JA}$ . In the 48-pin TQFP,  $\theta_{JA}$  is  $76^\circ C/W$ , so  $P_{DMAX} = 1,645 mW$  at  $25^\circ C$  and  $855 mW$  at the maximum operating ambient temperature of  $85^\circ C$ . Note that the power dissipation of this device under normal operation will typically be about  $307 mW$  ( $267 mW$  quiescent power +  $40 mW$  due to 1 LVTTTL load on each digital output). The values for maximum power dissipation listed above will be reached only when the ADC10D040 is operated in a severe fault condition (e.g. when input or output pins are driven beyond the power supply voltages, or the power supply polarity is reversed). Obviously, such conditions should always be avoided.

**Note 5:** Human body model is 100 pF capacitor discharged through a 1.5 k $\Omega$  resistor. Machine model is 220 pF discharged through 0 $\Omega$ .

**Note 6:** See AN450, "Surface Mounting Methods and Their Effect on Product Reliability", or the section entitled "Surface Mount" found in any post 1986 National Semiconductor Linear Data Book, for other methods of soldering surface mount devices.

**Note 7:** The inputs are protected as shown below. Input voltage magnitude up to 300 mV beyond the supply rails will not damage this device. However, errors in the A/D conversion can occur if the input goes beyond the limits given in these tables.

## AC Electrical Characteristics OS = High (Parallel Mode) (Continued)

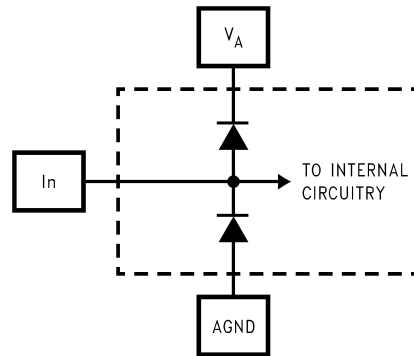

20029706

**Note 8:** Typical figures are at  $T_J = 25^\circ\text{C}$ , and represent most likely parametric norms.

**Note 9:** Test limits are guaranteed to National's AOQL (Average Outgoing Quality Level). Performance is guaranteed only at  $V_{REF} = 1.4\text{V}$  and a clock duty cycle of 50%. The limits for  $V_{REF}$  and clock duty cycle specify the range over which reasonable performance is expected. Tests are performed and limits guaranteed with clock low and high levels of 0.3V and  $V_D - 0.3\text{V}$ , respectively.

**Note 10:**  $I_{DR}$  is the current consumed by the switching of the output drivers and is primarily determined by the load capacitance on the output pins, the supply voltage,  $V_{DR}$ , and the rate at which the outputs are switching (which is signal dependent).  $I_{DR} = V_{DR} (C_O \times f_O + C_1 \times f_1 + \dots + C_9 \times f_9)$  where  $V_{DR}$  is the output driver power supply voltage,  $C_n$  is the total capacitance on the output pin, and  $f_n$  is the average frequency at which that pin is toggling.

# Timing Diagrams

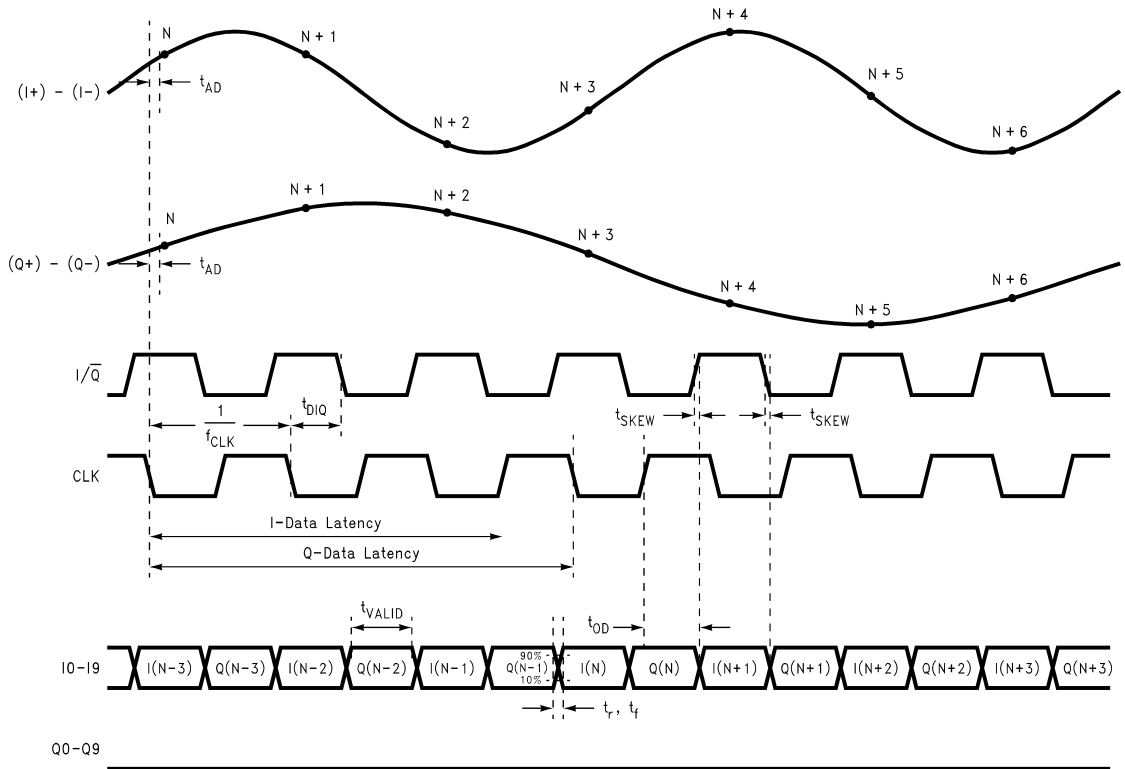

ADC10D040 Timing Diagram for Multiplexed Mode

20029708

Timing Diagrams (Continued)

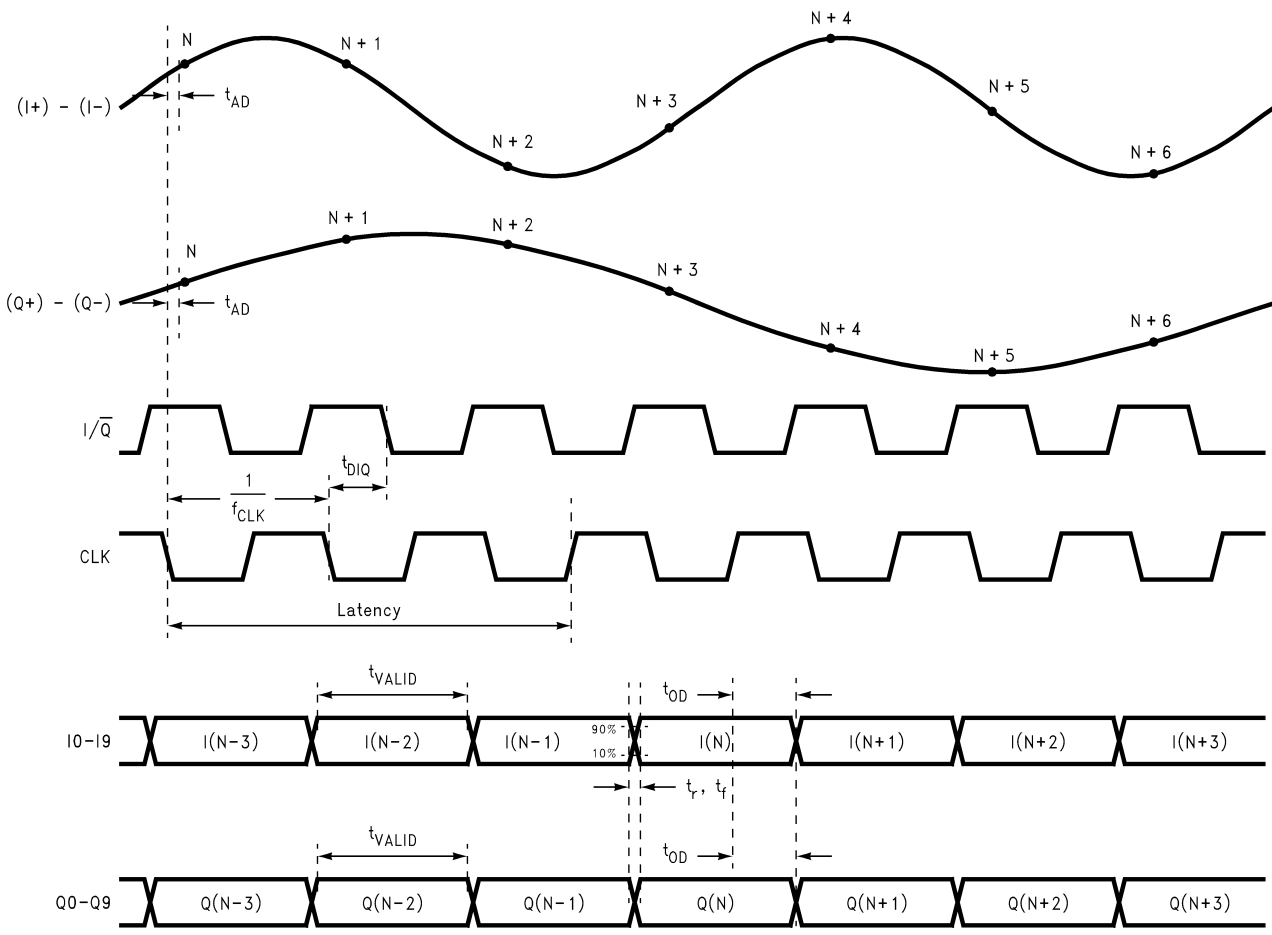

ADC10D040 Timing Diagram for Parallel Mode

20029707

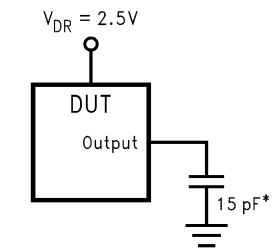

\* Includes stray and distributed capacitance

20029709

FIGURE 1. AC Test Circuit

## Specification Definitions

**APERTURE (SAMPLING) DELAY** is that time required after the fall of the clock input for the sampling switch to open. The Sample/Hold circuit effectively stops capturing the input signal and goes into the “hold” mode  $t_{AD}$  after the clock goes low.

**APERTURE JITTER** is the variation in aperture delay from sample to sample. Aperture jitter shows up as input noise.

**CLOCK DUTY CYCLE** is the ratio of the time that the clock waveform is high to the total time of one clock period.

**CROSSTALK** is coupling of energy from one channel into the other channel.

**DIFFERENTIAL NON-LINEARITY (DNL)** is the measure of the maximum deviation from the ideal step size of 1 LSB. Measured at 40 MSPS with a ramp input.

**EFFECTIVE NUMBER OF BITS (ENOB, or EFFECTIVE BITS)** is another method of specifying Signal-to-Noise and Distortion Ratio, or SINAD. ENOB is defined as  $(\text{SINAD} - 1.76)/6.02$  and says that the converter is equivalent to a perfect ADC of this (ENOB) number of bits.

**FULL POWER BANDWIDTH (FPBW)** is the frequency at which the magnitude of the reconstructed output fundamental drops 3 dB below its 1 MHz value.

**GAIN ERROR** is the difference between the ideal and actual differences between the input levels at which the first and last code transitions occur. That is, how far this difference is from Full Scale.

**INTEGRAL NON LINEARITY (INL)** is a measure of the maximum deviation of each individual code from a line drawn from negative full scale ( $1/2$  LSB below the first code transition) through positive full scale ( $1/2$  LSB above the last code transition). The deviation of any given code from this straight line is measured from the center of that code value. The end point test method is used. Measured at 40 MSPS with a ramp input.

**INTERMODULATION DISTORTION (IMD)** is the creation of spectral components that are not present in the input as a result of two sinusoidal frequencies being applied to the ADC input at the same time. It is defined as the ratio of the power in the second and third order intermodulation products to the total power in one of the original frequencies. IMD is usually expressed in dB.

**LSB (LEAST SIGNIFICANT BIT)** is the bit that has the smallest value of weight of all bits. This value is

$$m * V_{REF}/2^n$$

where “m” is the reference scale factor and “n” is the ADC resolution, which is 10 in the case of the ADC10D040. The value of “m” is determined by the logic level at the gain pin and has a value of 1 when the gain pin is at a logic low and a value of 2 when the gain pin is at a logic high.

**MISSING CODES** are those output codes that are skipped and will never appear at the ADC outputs. These codes cannot be reached with any input value.

**MSB (MOST SIGNIFICANT BIT)** is the bit that has the largest value or weight. Its value is one half of full scale.

**OFFSET ERROR** is a measure of how far the mid-scale transition point is from the ideal zero voltage input.

**OUTPUT DELAY** is the time delay after the rising edge of the input clock before the data update is present at the output pins.

**OVERRANGE RECOVERY TIME** is the time required after the differential input voltages goes from 1.5V to 0V for the converter to recover and make a conversion with its rated accuracy.

**PIPELINE DELAY (LATENCY)** is the number of clock cycles between initiation of conversion and when that data is presented to the output driver stage. New data is available at every clock cycle, but the data output lags the input by the Pipelined Delay plus the Output Delay.

**POWER SUPPLY REJECTION RATIO (PSRR)** can be one of two specifications. PSRR1 (DC PSRR) is the ratio of the change in full scale gain error that results from a power supply voltage change from 3.0V to 3.6V. PSRR2 (AC PSRR) is measured with a 10 MHz, 250 mV<sub>P-P</sub> signal riding upon the power supply and is the ratio of the signal amplitude on the power supply pins to the amplitude of that frequency at the output. PSRR is expressed in dB.

**SIGNAL TO NOISE RATIO (SNR)** is the ratio, expressed in dB, of the rms value of the fundamental signal at the output to the rms value of the sum of all other spectral components below one-half the sampling frequency, not including harmonics or dc.

**SIGNAL TO NOISE PLUS DISTORTION (S/(N+D) or SINAD)** is the ratio, expressed in dB, of the rms value of the fundamental signal at the output to the rms value of all of the other spectral components below half the clock frequency, including harmonics but excluding dc.

**SPURIOUS FREE DYNAMIC RANGE (SFDR)** is the difference, expressed in dB, between the rms values of the fundamental signal at the output and the peak spurious signal, where a spurious signal is any signal present in the output spectrum that is not present at the input.

**TOTAL HARMONIC DISTORTION (THD)** is the ratio, expressed in dB, of the total of the first nine harmonic levels at the output to the level of the fundamental at the output. THD is calculated as

$$\text{THD} = 20 \times \log \sqrt{\frac{f_2^2 + f_3^2 + f_4^2 + f_5^2 + f_6^2 + f_7^2 + f_8^2 + f_9^2 + f_{10}^2}{f_1^2}}$$

where  $f_1$  is the RMS power of the fundamental (output) frequency and  $f_2$  through  $f_{10}$  are the RMS power of the first 9 harmonic frequencies in the output spectrum.

**Typical Performance Characteristics**  $V_A = V_D = 3.3V$ ,  $V_{DR} = 2.5V$ ,  $f_{CLK} = 40\text{ MHz}$ ,  $f_{IN} = 10.4\text{ MHz}$ , unless otherwise specified

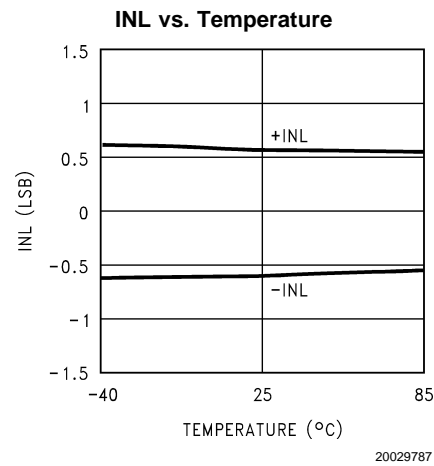
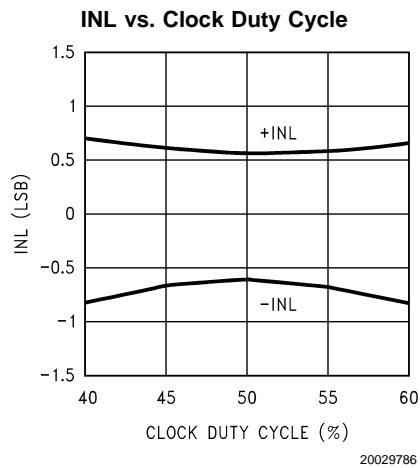
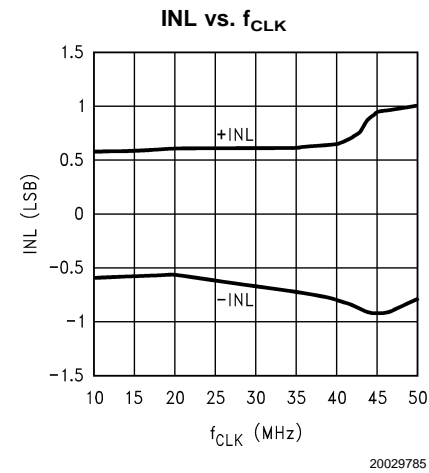
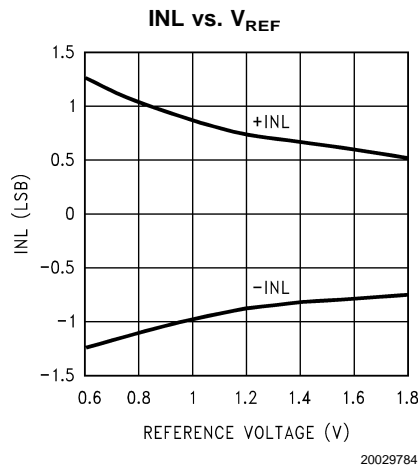
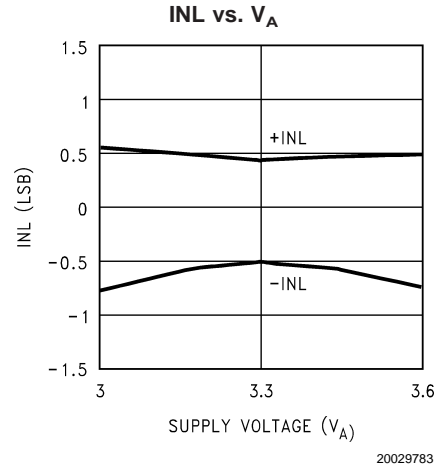
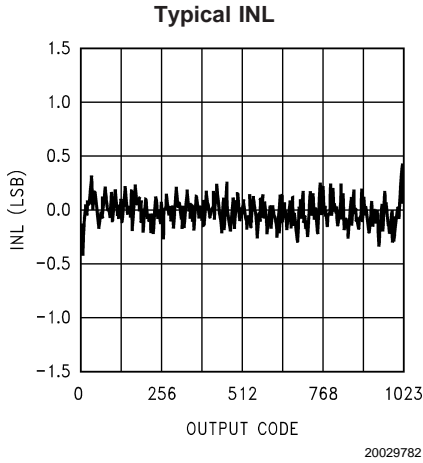

**Typical Performance Characteristics**  $V_A = V_D = 3.3V$ ,  $V_{DR} = 2.5V$ ,  $f_{CLK} = 40\text{ MHz}$ ,  $f_{IN} = 10.4\text{ MHz}$ , unless otherwise specified (Continued)

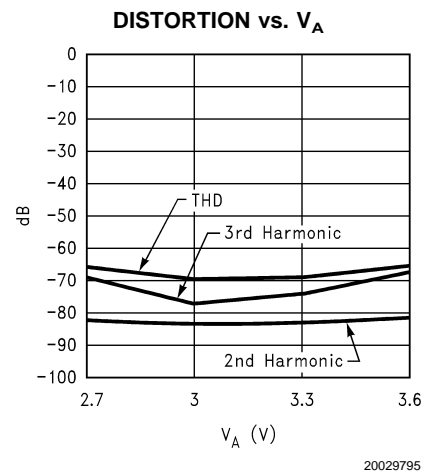
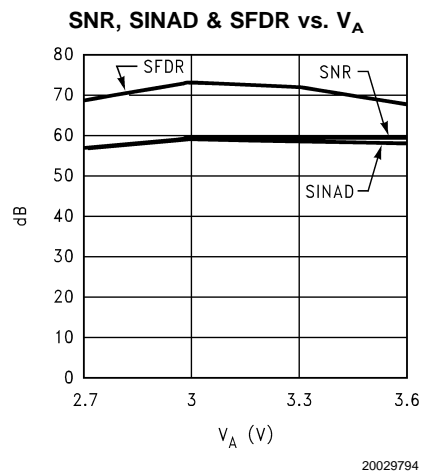
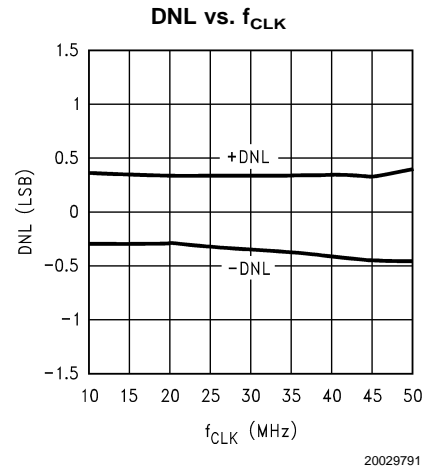
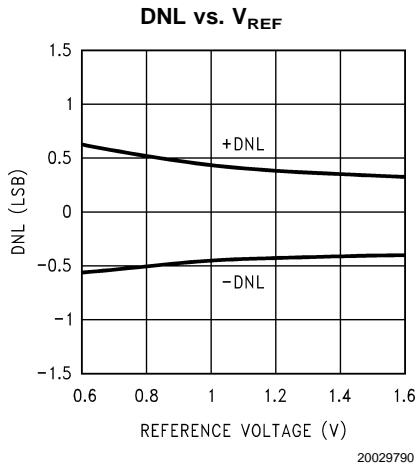
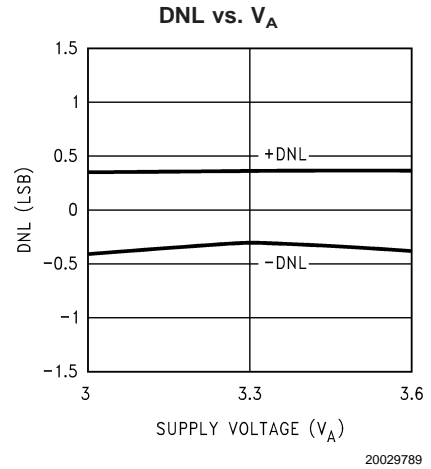
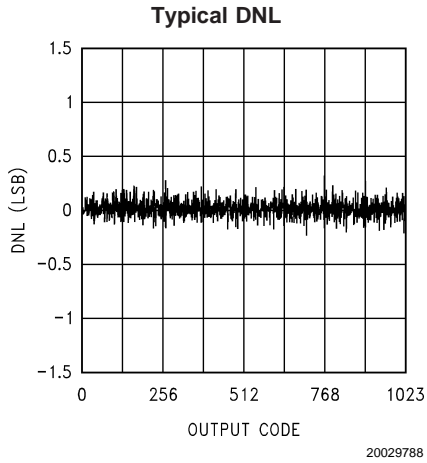

**Typical Performance Characteristics**  $V_A = V_D = 3.3V$ ,  $V_{DR} = 2.5V$ ,  $f_{CLK} = 40\text{ MHz}$ ,  $f_{IN} = 10.4\text{ MHz}$ , unless otherwise specified (Continued)

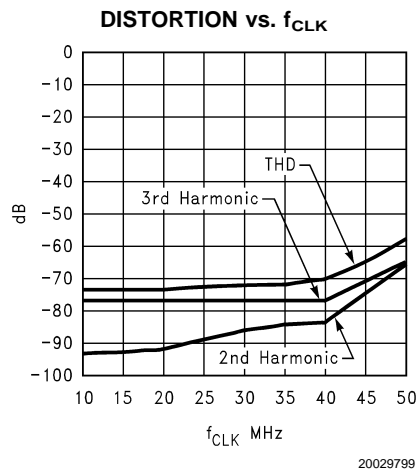
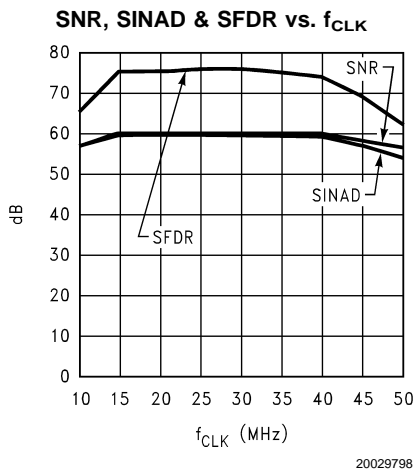
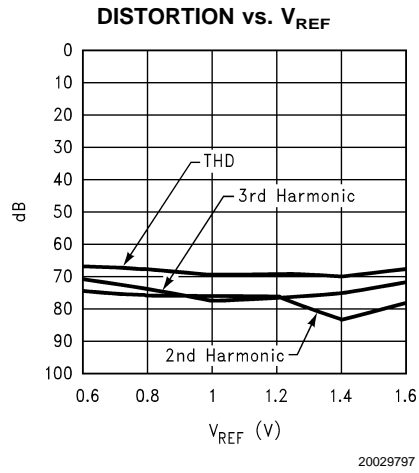
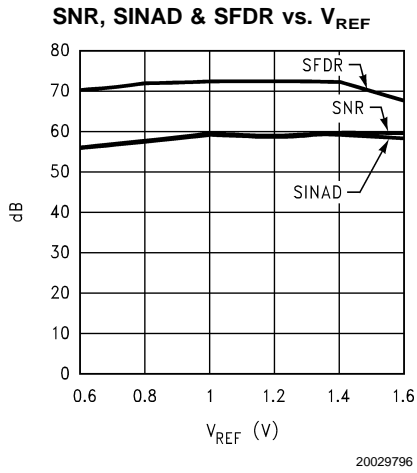
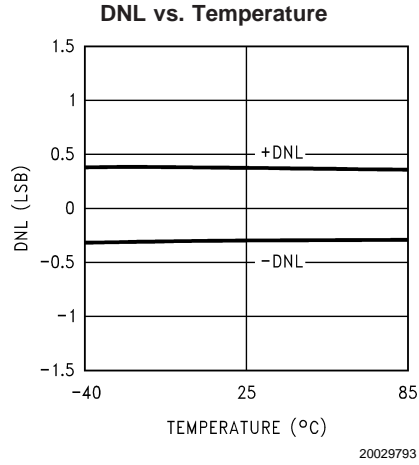
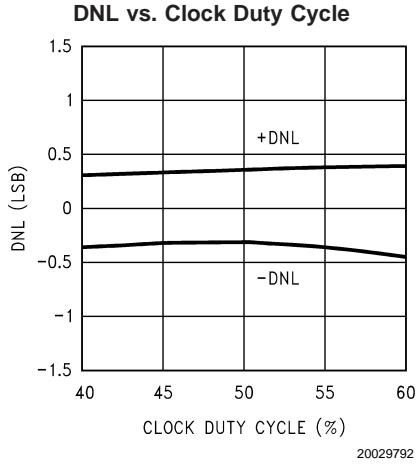

**Typical Performance Characteristics**  $V_A = V_D = 3.3V$ ,  $V_{DR} = 2.5V$ ,  $f_{CLK} = 40\text{ MHz}$ ,  $f_{IN} = 10.4\text{ MHz}$ , unless otherwise specified (Continued)

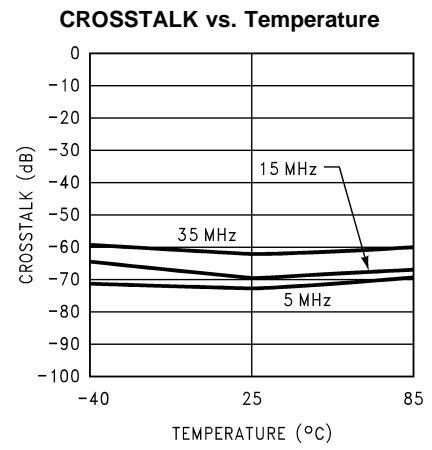
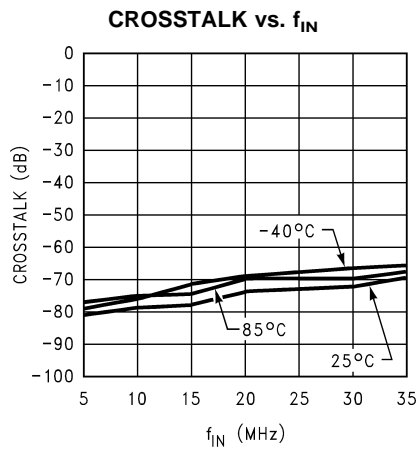
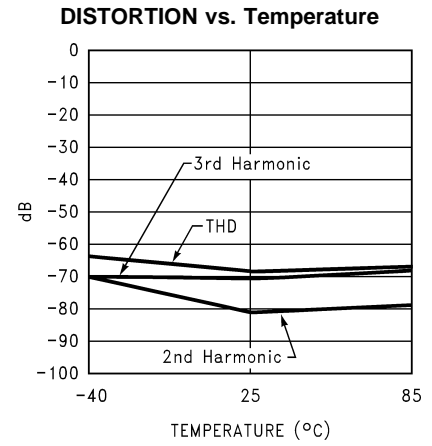
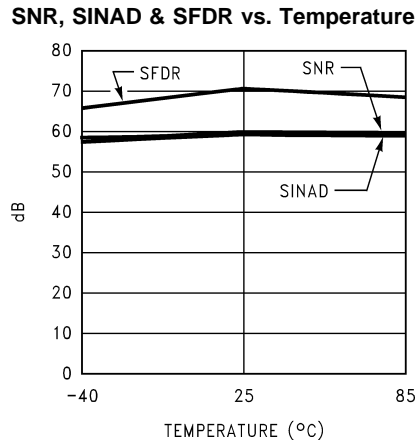
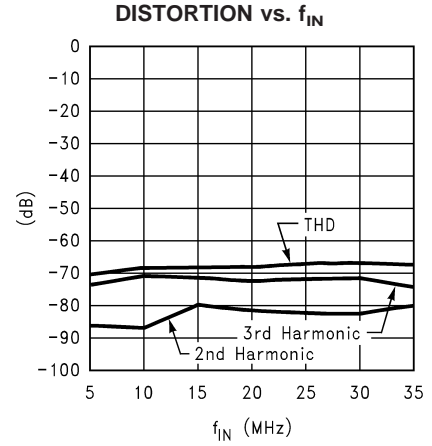
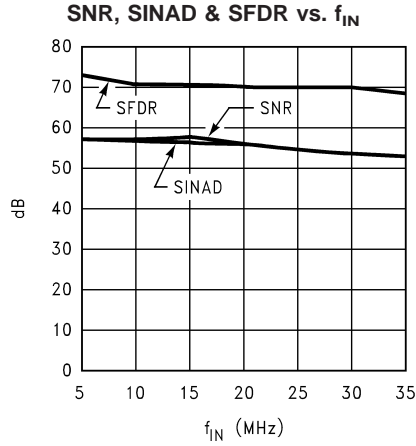

**Typical Performance Characteristics**  $V_A = V_D = 3.3V$ ,  $V_{DR} = 2.5V$ ,  $f_{CLK} = 40\text{ MHz}$ ,  $f_{IN} = 10.4\text{ MHz}$ , unless otherwise specified (Continued)

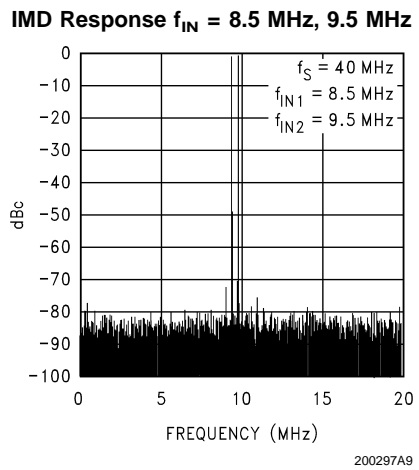
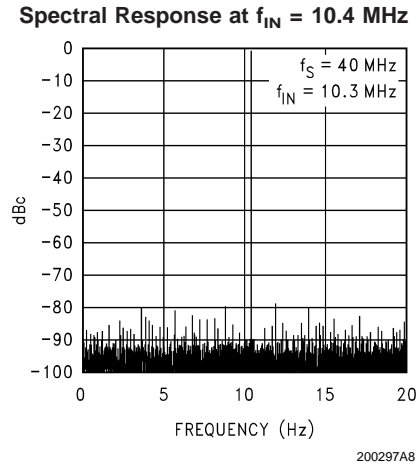
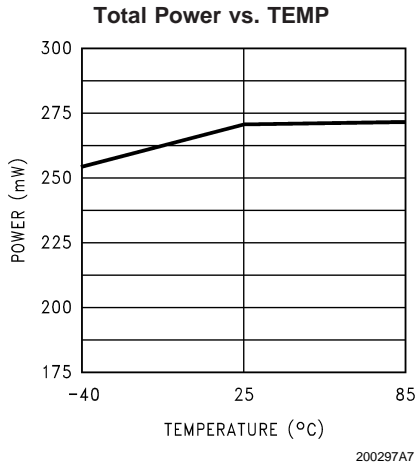

## Functional Description

Using a subranging architecture, the ADC10D040 achieves 9.4 effective bits over the entire Nyquist band at 40 MSPS while consuming just 267 mW. The use of an internal sample-and-hold amplifier (SHA) not only enables this sustained dynamic performance, but also lowers the converter's input capacitance and reduces the number of external components required.

Analog signals at the "I" and "Q" inputs that are within the voltage range set by  $V_{REF}$  and the GAIN pin are digitized to ten bits at up to 45 MSPS.  $V_{REF}$  has a range of 0.6V to 1.6V, providing a differential peak-to-peak input range of  $0.6 V_{P-P}$  to  $1.6 V_{P-P}$  with the GAIN pin at a logic low, or a differential input range of  $1.2 V_{P-P}$  to  $3.2 V_{P-P}$  with the GAIN pin at a logic high. Differential input voltages less than  $-V_{REF}/2$  with the GAIN pin low, or less than  $-V_{REF}$  with the GAIN pin high will cause the output word to indicate a negative full scale. Differential input voltages greater than  $V_{REF}/2$  with the GAIN pin low, or greater than  $V_{REF}$  with the GAIN pin high, will cause the output word to indicate a positive full scale.

Both "I" and "Q" channels are sampled simultaneously on the falling edge of the clock input, while the timing of the data output depends upon the mode of operation.

In the parallel mode, the "I" and "Q" output busses contain the conversion result for their respective inputs. The "I" and "Q" channel data are present and valid at the data output pins  $t_{OD}$  after the rising edge of the input clock. In the multiplexed mode, "I" channel data is available at the digital outputs  $t_{OD}$  after the rise of the clock edge, while the "Q" channel data is available at the I0 through I9 digital outputs  $t_{OD}$  after the fall of the clock. However, a delayed  $I/\bar{Q}$  output signal should be used to latch the output for best, most consistent results.

Data latency in the parallel mode is 2.5 clock cycles. In the multiplexed mode data latency is 2.5 clock cycles for the "I" channel and 3.0 clock cycles for the "Q" channel. The ADC10D040 will convert as long as the clock signal is present and the PD and STBY pins are low.

Throughout this discussion,  $V_{CM}$  refers to the Common Mode input voltage of the ADC10D040 while  $V_{CMO}$  refers to its Common Mode output voltage.

## Applications Information

### 1.0 THE ANALOG SIGNAL INPUTS

Each of the analog inputs of the ADC10D040 consists of a switch (transmission gate) followed by a switched capacitor amplifier. The capacitance seen at each input pin changes with the clock level, appearing as about 2 pF when the clock is low, and about 5 pF when the clock is high. A switched capacitance is harder to drive than is a larger, fixed capacitance.

The CLC409 and the CLC428 dual op amp have been found to be a good amplifiers to drive the ADC10D040 because of their wide bandwidth and low distortion. They also have good Differential Gain and Differential Phase performance.

Care should be taken to avoid driving the input beyond the supply rails, even momentarily, as during power-up.

The ADC10D040 is designed for differential input signals for best performance. With a 1.4V reference and the GAIN pin at a logic low, differential input signals up to  $1.4 V_{P-P}$  are digitized. See *Figure 2*. For differential signals, the input

common mode is expected to be about 1.5V, but the inputs are not sensitive to the common-mode voltage and can be anywhere within the supply rails (ground to  $V_A$ ) with little or no performance degradation, as long as the signal swing at the individual input pins is no more than 300 mV beyond the supply rails. For single ended drive, operate the ADC10D040 with the GAIN pin at a logic low, connect one pin of the input pair to 1.5V ( $V_{CM}$ ) and drive the other pin of the input pair with  $1.4 V_{P-P}$  centered around 1.5V.

Because of the larger signal swing at one input for single-ended operation, distortion performance will not be as good as with a differential input signal. Alternatively, single-ended to differential conversion with a transformer provides a quick, easy solution for those applications not requiring response to dc and low frequencies. See *Figure 3*. The  $36\Omega$  resistors and 56 pF capacitor values are chosen to provide a cutoff frequency near the clock frequency to compensate for the effects of input sampling. A lower time constant should be used for undersampling applications.

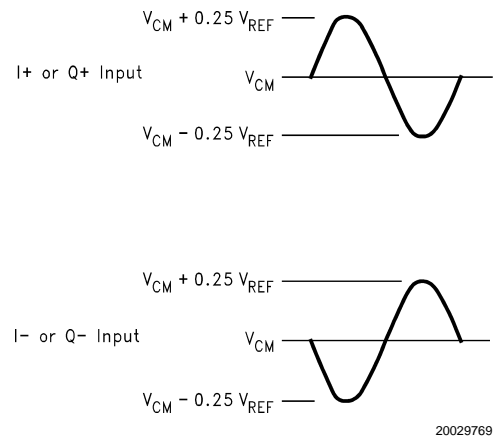

**FIGURE 2. The ADC10D040 is designed for use with differential signals of  $1.4 V_{P-P}$  with a common mode voltage of 1.5V. The signal swing should not cause any pin to experience a swing more than 300 mV beyond the supply rails.**

### 2.0 REFERENCE INPUTS

The  $V_{RP}$  and  $V_{RN}$  pins should each be bypassed with a  $5 \mu\text{F}$  (or larger) tantalum or electrolytic capacitor and a  $0.1 \mu\text{F}$  ceramic capacitor. Use these pins only for bypassing. DO NOT connect anything else to these pins.

*Figure 4* shows a simple reference biasing scheme with minimal components. While this circuit will suffice for many applications, the value of the reference voltage will depend upon the supply voltage.

The circuit of *Figure 5* is an improvement over the circuit of *Figure 4* because the reference voltage is independent of supply voltage. This reduces problems of reference voltage variability. The reference voltage at the  $V_{REF}$  pin should be bypassed to AGND with a  $5 \mu\text{F}$  (or larger) tantalum or electrolytic capacitor and a  $0.1 \mu\text{F}$  ceramic capacitor.

The circuit of *Figure 6* may be used if it is desired to obtain a precise reference voltage not available with a fixed reference source. The  $604\Omega$  and  $1.40k$  resistors can be replaced with a potentiometer, if desired.

Applications Information (Continued)

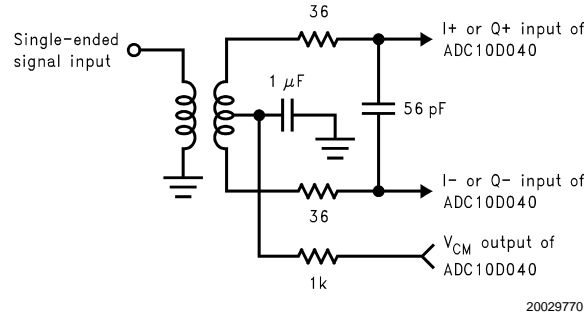

FIGURE 3. Use of an input transformer for single-ended to differential conversion can simplify circuit design for single-ended signals.

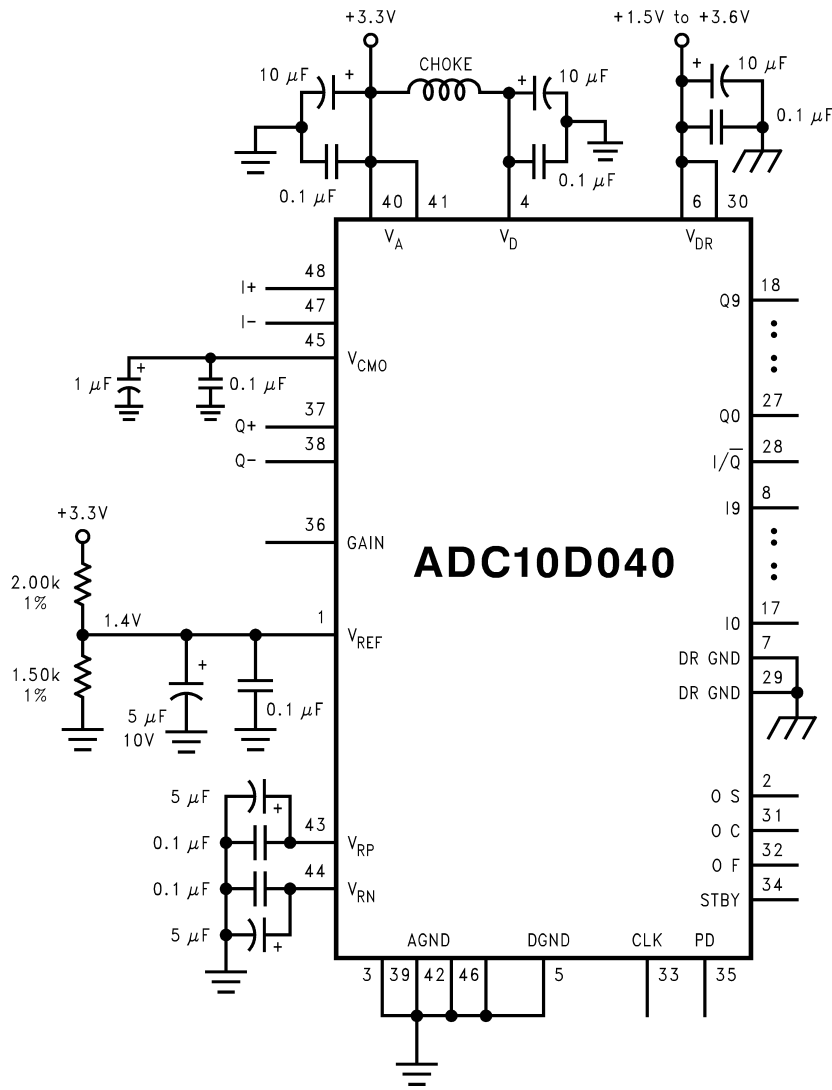
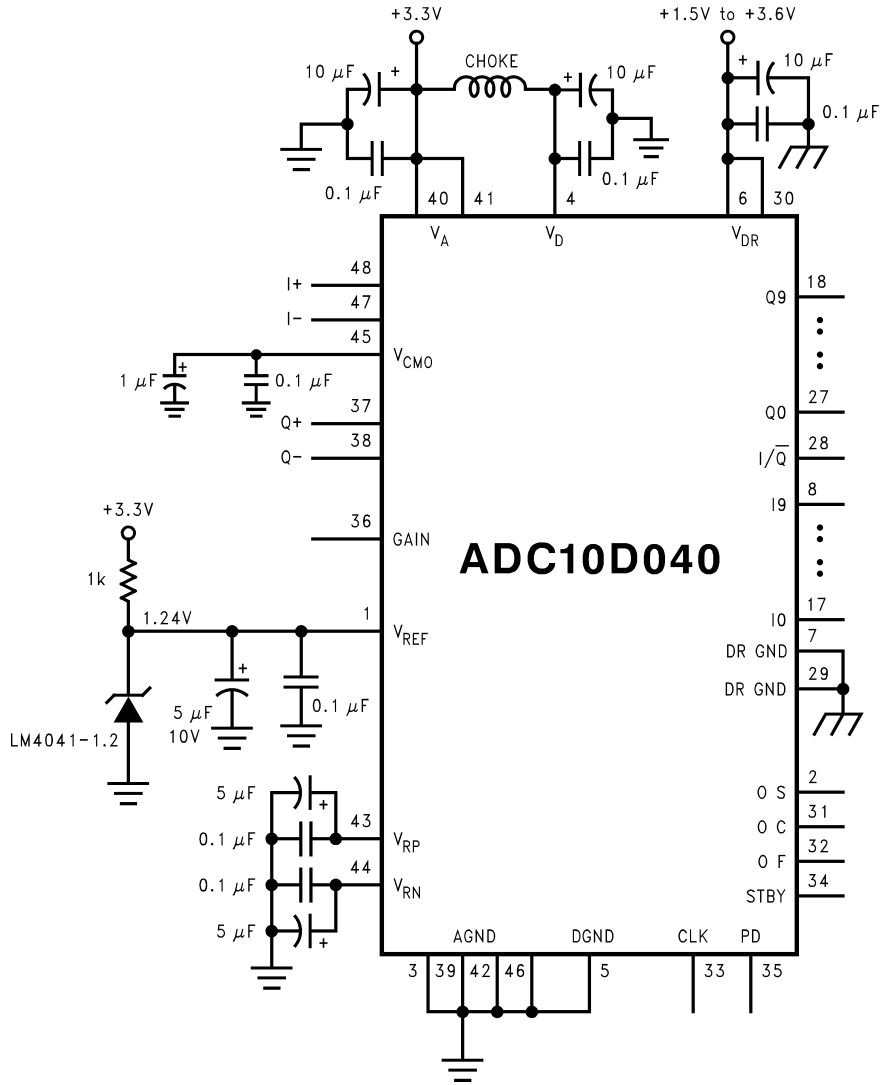

FIGURE 4. Simple Reference Biasing

Applications Information (Continued)



20029772

FIGURE 5. Improved Low Component Count Reference Biasing





## Applications Information (Continued)

### 2.2 $V_{CMO}$ OUTPUT

The  $V_{CMO}$  output pin is intended to provide a common mode bias for the differential input pins of the ADC10D040. It can also be used as a voltage reference source. Care should be taken, however, to avoid loading this pin with more than 1 mA. A load greater than this could result in degraded long term and temperature stability of this voltage. The  $V_{CMO}$  pin is output compensated and should be bypassed with a 1  $\mu$ F/0.1  $\mu$ F combination, minimum. See 2.0 REFERENCE INPUTS for more information on using the  $V_{CMO}$  output as a reference source.

### 3.0 DIGITAL INPUT PINS

The seven digital input pins are used to control the function of the ADC10D040.

#### 3.1 CLOCK (CLK) INPUT

The clock (CLK) input is common to both A/D converters. This pin is CMOS/LVTTL compatible with a threshold of about  $V_A/2$ . Although the ADC10D040 is tested and its performance is guaranteed with a 40 MHz clock, it typically will function well with low-jitter clock frequencies from 1 MHz to 45 MHz. The clock source should be series terminated to match the source impedance with the characteristic impedance,  $Z_o$ , of the clock line and the ADC clock pin should be AC terminated, near the clock input, with a 100 $\Omega$  resistor in series with a capacitor such that  $C \times Z_o \geq 4 \times t_{PD}$ , where  $t_{PD}$  is the time of propagation of the clock signal from its source to the ADC clock pin. The typical propagation rate on a board of FR4 material is about 150ps/inch. The rise and fall times of the clock supplied to the ADC clock pin should be no more than 2 ns. The analog inputs  $I = (I+) - (I-)$  and  $Q = (Q+) - (Q-)$  are simultaneously sampled on the falling edge of this input to ensure the best possible aperture delay match between the two channels.

#### 3.2 OUTPUT BUS SELECT (OS) PIN

The Output Bus Select (OS) pin determines whether the ADC10D040 is in the parallel or multiplexed mode of operation. A logic high at this pin puts the device into the parallel mode of operation where "I" and "Q" data appear at their respective output buses. A logic low at this pin puts the device into the multiplexed mode of operation where the "I" and "Q" data are multiplexed onto the "I" output bus and the "Q" output lines all remain at a logic low.

#### 3.3 OFFSET CORRECT (OC) PIN

The Offset Correct (OC) pin is used to initiate an offset correction sequence. This procedure should be done after power up and need not be performed again unless power to the ADC10D040 is interrupted. An independent offset cor-

rection sequence for each converter is initiated when there is a low-to-high transition at the OC pin. This sequence takes 34 clock cycles to complete, during which time 32 conversions are taken and averaged. The result is subtracted from subsequent conversions. Because the offset correction is performed digitally at the output of the ADC, the output range of the ADC is reduced by the offset amount.

Each input pair should have a 0V differential voltage value during this entire 34 clock period, but the "I" and "Q" input common mode voltages do not have to be equal to each other. Because of the uncertainty as to exactly when the correction sequence starts, it is best to allow 35 clock periods for this sequence.

#### 3.4 OUTPUT FORMAT (OF) PIN

The Output Format (OF) pin provides a choice of straight binary or 2's complement output formatting. With this pin at a logic low, the output format is straight binary. With this pin at a logic high, the output format is 2's complement.

#### 3.5 STANDBY (STBY) PIN

The Standby (STBY) pin may be used to put the ADC10D040 into a low power mode where it consumes just 30 mW and can quickly be brought to full operation. The device operates normally with a logic low on this and the PD pins.

#### 3.6 POWER DOWN (PD) PIN

The Power Down (PD) pin puts the device into a low-power "sleep" state where it consumes less than 1 mW when the PD pin is at a logic high. Power consumption is reduced more when the PD pin is high than when the STBY pin is high, but recovery to full operation is much quicker from the standby state than it is from the power down state. When the STBY and PD pins are both high, the ADC10D040 is in the power down mode.

#### 3.7 GAIN PIN

The GAIN pin sets the internal signal gain of the "I" and "Q" inputs. With this pin at a logic low, the full scale differential peak-to-peak input signal is equal to  $V_{REF}$ . With the GAIN pin at a logic high, the full scale differential peak-to-peak input signal is equal to 2 times  $V_{REF}$ .

### 4.0 INPUT/OUTPUT RELATIONSHIP ALTERNATIVES

The GAIN pin of the ADC10D040 offers input range selection, while the OF pin offers a choice of straight binary or 2's complement output formatting.

The relationship between the GAIN, OF, analog inputs and the output code are as defined in *Table 1*. Keep in mind that the input signals must not exceed the power supply rails.

## Applications Information (Continued)

TABLE 1. ADC10D040 Input/Output Relationships

GAIN	OF	I+/Q+	I-/Q-	Output Code
0	0	$V_{CM} + 0.25 \cdot V_{REF}$	$V_{CM} - 0.25 \cdot V_{REF}$	11 1111 1111
0	0	$V_{CM}$	$V_{CM}$	10 0000 0000
0	0	$V_{CM} - 0.25 \cdot V_{REF}$	$V_{CM} + 0.25 \cdot V_{REF}$	00 0000 0000
0	1	$V_{CM} + 0.25 \cdot V_{REF}$	$V_{CM} - 0.25 \cdot V_{REF}$	01 1111 1111
0	1	$V_{CM}$	$V_{CM}$	00 0000 0000
0	1	$V_{CM} - 0.25 \cdot V_{REF}$	$V_{CM} + 0.25 \cdot V_{REF}$	10 0000 0000
1	0	$V_{CM} + 0.5 \cdot V_{REF}$	$V_{CM} - 0.5 \cdot V_{REF}$	11 1111 1111
1	0	$V_{CM}$	$V_{CM}$	10 0000 0000
1	0	$V_{CM} - 0.5 \cdot V_{REF}$	$V_{CM} + 0.5 \cdot V_{REF}$	00 0000 0000
1	1	$V_{CM} + 0.5 \cdot V_{REF}$	$V_{CM} - 0.5 \cdot V_{REF}$	01 1111 1111
1	1	$V_{CM}$	$V_{CM}$	00 0000 0000
1	1	$V_{CM} - 0.5 \cdot V_{REF}$	$V_{CM} + 0.5 \cdot V_{REF}$	10 0000 0000

### 5.0 POWER SUPPLY CONSIDERATIONS

A/D converters draw sufficient transient current to corrupt their own power supplies if not adequately bypassed. A 10  $\mu$ F to 50  $\mu$ F tantalum or aluminum electrolytic capacitor should be placed within half an inch (1.2 centimeters) of the A/D power pins, with a 0.1  $\mu$ F ceramic chip capacitor placed as close as possible to each of the converter's power supply pins. Leadless chip capacitors are preferred because they have low lead inductance.

While a single voltage source should be used for the analog and digital supplies of the ADC10D040, these supply pins should be well isolated from each other to prevent any digital noise from being coupled to the analog power pins. A choke is recommended between the  $V_A$  and  $V_D$  supply lines.  $V_{DR}$  should have a separate supply from  $V_A$  and  $V_D$  to avoid noise coupling into the input. Be sure to bypass  $V_{DR}$ .

The  $V_{DR}$  pin is completely isolated from the other supply pins. Because of this isolation, a separate supply can be used for these pins. This  $V_{DR}$  supply can be significantly lower than the three volts used for the other supplies, easing the interface to lower voltage digital systems. Using a lower voltage for this supply can also reduce the power consumption and noise associated with the output drivers.

The converter digital supply should **not** be the supply that is used for other digital circuitry on the board. It should be the same supply used for the ADC10D040 analog supply.

As is the case with all high speed converters, the ADC10D040 should be assumed to have little high frequency power supply rejection. A clean analog power source should be used.

No pin should ever have a voltage on it that is more than 300 mV in excess of the supply voltages or below ground, not even on a transient basis. This can be a problem upon application of power to a circuit and upon turn off of the power source. Be sure that the supplies to circuits driving the CLK, or any other digital or analog inputs do not come up any faster than does the voltage at the ADC10D040 power pins.

### 6.0 LAYOUT AND GROUNDING

Proper routing of all signals and proper ground techniques are essential to ensure accurate conversion. Separate analog and digital ground planes may be used if adequate care is taken with signal routing, but may result in EMI/RFI. A single ground plane with proper component placement will yield good results while minimizing EMI/RFI.

Analog and digital ground current paths should not coincide with each other as the common impedance will cause digital noise to be added to analog signals. Accordingly, traces carrying digital signals should be kept as far away from traces carrying analog signals as is possible. Power should be routed with traces rather than the use of a power plane. The analog and digital power traces should be kept well away from each other. All power to the ADC10D040, except  $V_{DR}$ , should be considered analog. The DR GND pin should be considered a digital ground and not be connected to the ground plane in close proximity with the other ground pins of the ADC10D040.

Each bypass capacitor should be located as close to the appropriate converter pin as possible and connected to the pin and the appropriate ground plane with short traces. The analog input should be isolated from noisy signal traces to avoid coupling of spurious signals into the input. Any external component (e.g., a filter capacitor) connected between the converter's input and ground should be connected to a very clean point in the ground return.

The clock line should be properly terminated, as discussed in Section 3.1, and be as short as possible.

Figure 8 gives an example of a suitable layout and bypass capacitor placement. All analog circuitry (input amplifiers, filters, reference components, etc.) and interconnections should be placed in an area reserved for analog circuitry. All digital circuitry and I/O lines should be placed in an area reserved for digital circuitry. Violating these rules can result in digital noise getting into the analog circuitry, which will degrade accuracy and dynamic performance (THD, SNR, SINAD).

Applications Information (Continued)

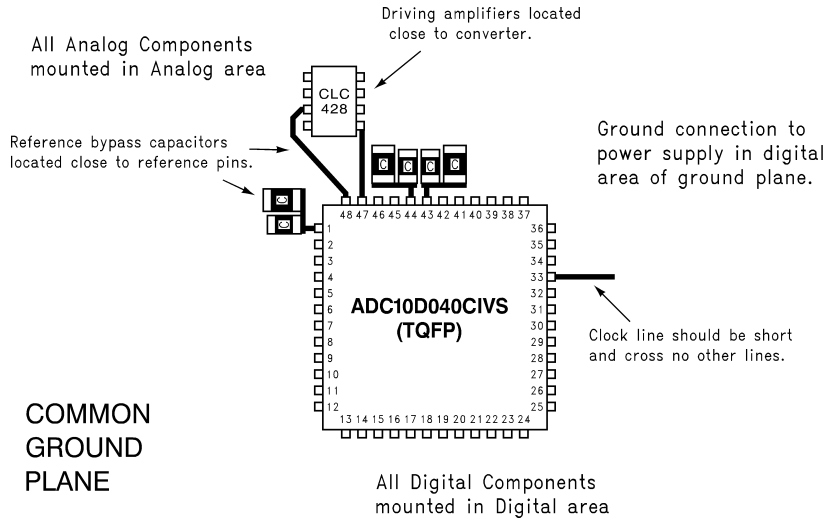

20029775

FIGURE 8. An Acceptable Layout Pattern

7.0 DYNAMIC PERFORMANCE

The ADC10D040 is ac tested and its dynamic performance is guaranteed. To meet the published specifications, the clock source driving the CLK input must be free of jitter. For best dynamic performance, isolating the ADC clock from any digital circuitry should be done with adequate buffers, as with a clock tree. See Figure 9.

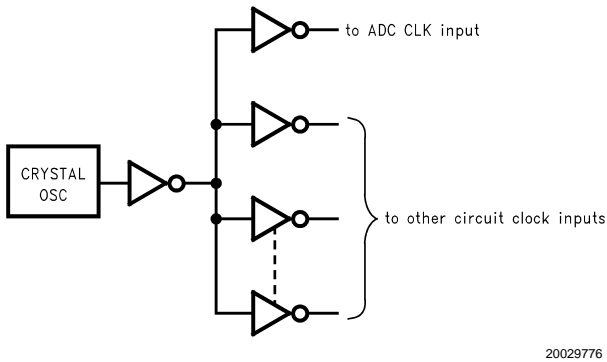

20029776

FIGURE 9. Isolating the ADC Clock from Digital Circuitry

8.0 COMMON APPLICATION PITFALLS

**Driving the inputs (analog or digital) beyond the power supply rails.** For proper operation, no input should go more than 300 mV beyond the supply pins. Exceeding these limits

on even a transient basis can cause faulty or erratic operation. It is not uncommon for high speed digital circuits (e.g., 74F and 74AC devices) to exhibit overshoot and undershoot that goes a few hundred millivolts beyond the supply rails. A resistor of 50Ω to 100Ω in series with the offending digital input, close to the source, will usually eliminate the problem.

Care should be taken not to overdrive the inputs of the ADC10D040 (or any device) with a device that is powered from supplies outside the range of the ADC10D040 supply. Such practice may lead to conversion inaccuracies and even to device damage.

**Attempting to drive a high capacitance digital data bus.**

The more capacitance the output drivers have to charge for each conversion, the more instantaneous digital current is required from  $V_{DR}$  and DR GND. These large charging current spikes can couple into the analog section, degrading dynamic performance. Adequate bypassing and attention to board layout will reduce this problem. Buffering the digital data outputs (with a 74ACTQ841, for example) may be necessary if the data bus to be driven is heavily loaded. Dynamic performance can also be improved by adding series resistors of 47Ω to 56Ω at each digital output, close to the ADC output pins.

**Using a clock source with excessive jitter.** This will cause the sampling interval to vary, causing excessive output noise and a reduction in SNR and SINAD performance. The use of simple gates with RC timing as a clock source is generally inadequate.

**Using the same voltage source for  $V_D$  and external digital logic.** As mentioned in Section 5.0,  $V_D$  should use the same power source used by  $V_A$  and other analog components, but should be decoupled from  $V_A$ .

**Physical Dimensions** inches (millimeters) unless otherwise noted

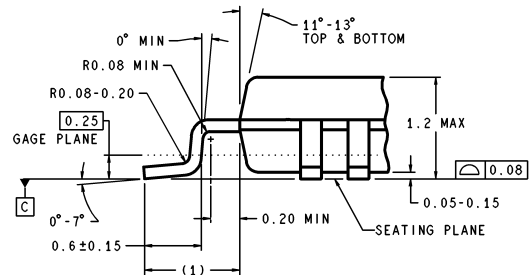
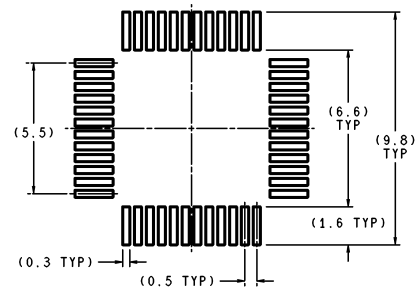
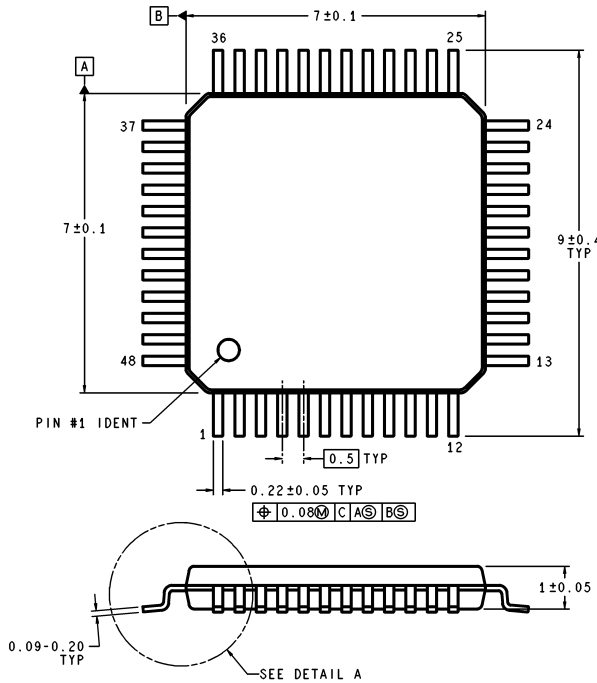

DIMENSIONS ARE IN MILLIMETERS

DETAIL A

VBC48A (Rev A)

**48-Lead TQFP Package**  
**Ordering Number ADC10D040CIVS**  
**NS Package Number VBA48A**

**NOTES UNLESS OTHERWISE SPECIFIED**

1. STANDARD LEAD FINISH  
 7.62 MICROMETERS MINIMUM SOLDER PLATING (85/15)  
 THICKNESS ON ALLOY 42/COPPER.
2. DIMENSION DOES NOT INCLUDE MOLD PROTRUSION.  
 MAXIMUM ALLOWABLE MOLD PROTRUSION 0.15 mm PER SIDE.
3. REFERENCE JEDEC REGISTRATION MS-026, VARIATION ABC,  
 DATED FEBRUARY 1999.

**LIFE SUPPORT POLICY**

NATIONAL'S PRODUCTS ARE NOT AUTHORIZED FOR USE AS CRITICAL COMPONENTS IN LIFE SUPPORT DEVICES OR SYSTEMS WITHOUT THE EXPRESS WRITTEN APPROVAL OF THE PRESIDENT AND GENERAL COUNSEL OF NATIONAL SEMICONDUCTOR CORPORATION. As used herein:

1. Life support devices or systems are devices or systems which, (a) are intended for surgical implant into the body, or (b) support or sustain life, and whose failure to perform when properly used in accordance with instructions for use provided in the labeling, can be reasonably expected to result in a significant injury to the user.
2. A critical component is any component of a life support device or system whose failure to perform can be reasonably expected to cause the failure of the life support device or system, or to affect its safety or effectiveness.



**National Semiconductor Corporation**  
 Americas  
 Email: support@nsc.com

**National Semiconductor Europe**  
 Fax: +49 (0) 180-530 85 86  
 Email: europe.support@nsc.com  
 Deutsch Tel: +49 (0) 69 9508 6208  
 English Tel: +44 (0) 870 24 0 2171  
 Français Tel: +33 (0) 1 41 91 8790

**National Semiconductor Asia Pacific Customer Response Group**  
 Tel: 65-2544466  
 Fax: 65-2504466  
 Email: ap.support@nsc.com

**National Semiconductor Japan Ltd.**  
 Tel: 81-3-5639-7560  
 Fax: 81-3-5639-7507

www.national.com