

# ADC1173

## 8-Bit, 3-Volt, 15MSPS, 33mW A/D Converter

### General Description

The ADC1173 is a low power, 15 MSPS analog-to-digital converter that digitizes signals to 8 bits while consuming just 33 mW of power (typ). The ADC1173 uses a unique architecture that achieves 7.6 Effective Bits. Output formatting is straight binary coding.

The excellent DC and AC characteristics of this device, together with its low power consumption and +3V single supply operation, make it ideally suited for many video, imaging and communications applications, including use in portable equipment. Furthermore, the ADC1173 is resistant to latch-up and the outputs are short-circuit proof. The top and bottom of the ADC1173's reference ladder is available for connections, enabling a wide range of input possibilities.

The ADC1173 is offered in SOIC (EIAJ) and TSSOP. It is designed to operate over the commercial temperature range of -40°C to +75°C.

### Features

- Internal Sample-and-Hold Function
- Single +3V Operation
- Internal Reference Bias Resistors
- Industry Standard Pinout
- TRI-STATE® Outputs

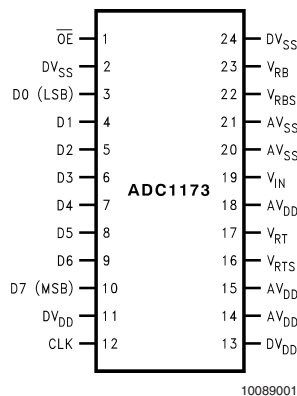
### Key Specifications

- Resolution 8 Bits
- Maximum Sampling Frequency 15 MSPS (min)
- THD -54 dB (typ)
- DNL ±0.85 LSB (max)
- ENOB at 3.58 MHz Input 7.6 Bits (typ)
- Guaranteed No Missing Codes
- Differential Phase 0.5 Degree (max)
- Differential Gain 1.5% (typ)
- Power Consumption 33mW (typ)
- (excluding reference current)

### Applications

- Video Digitization
- Digital Still Cameras
- Set Top Boxes
- Camcorders
- Personal Computer Video
- Digital Television
- CCD Imaging
- Electro-Optics

### Pin Configuration

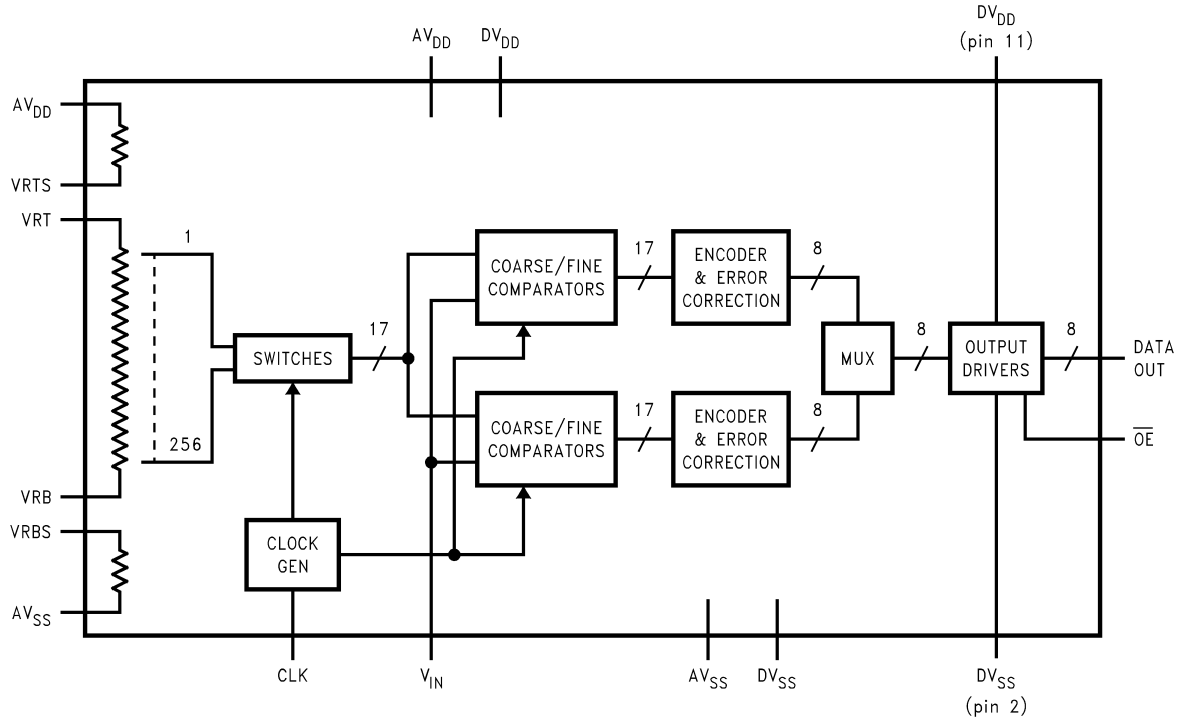


TRISTATE® is a registered trademark of National Semiconductor Corporation.

## Ordering Information

Industrial ( $-40^{\circ}\text{C} \leq T_A \leq +75^{\circ}\text{C}$ )	Package
ADC1173CIJM	SOIC (EIAJ)
ADC1173CIJMX	SOIC (EIAJ) (tape & reel)
ADC1173CIMTC	TSSOP
ADC1173CIMTCX	TSSOP (tape & reel)
ADC1173EVAL	Evaluation Board

## Block Diagram

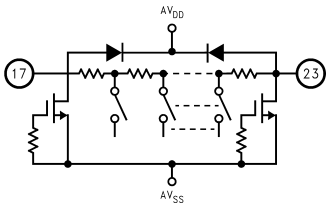
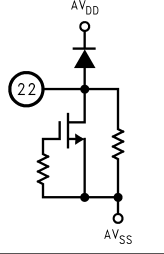
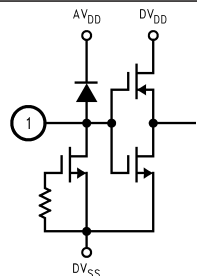
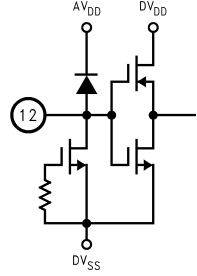
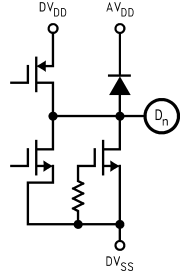


10089002

## Pin Descriptions and Equivalent Circuits

Pin No.	Symbol	Equivalent Circuit	Description
19	$V_{IN}$		Analog signal input. Conversion range is $V_{RB}$ to $V_{RT}$ .
16	$V_{RTS}$		Reference Top Bias with internal pull-up resistor. Short this pin to $V_{RT}$ to self bias the reference ladder.

**Pin Descriptions and Equivalent Circuits** (Continued)

Pin No.	Symbol	Equivalent Circuit	Description
17	$V_{RT}$		Analog Input that is the high (top) side of the reference ladder of the ADC. Nominal range is 1.0V to $AV_{DD}$ . Voltage on $V_{RT}$ and $V_{RB}$ inputs define the $V_{IN}$ conversion range. Bypass well. See Section 2.0 for more information.
23	$V_{RB}$		Analog Input that is the low (bottom) side of the reference ladder of the ADC. Nominal range is 0V to 2.0V. Voltage on $V_{RT}$ and $V_{RB}$ inputs define the $V_{IN}$ conversion range. Bypass well. See Section 2.0 for more information.
22	$V_{RBS}$		Reference Bottom Bias with internal pull down resistor. Short to $V_{RB}$ to self bias the reference ladder.
1	$\overline{OE}$		CMOS/TTL compatible Digital input that, when low, enables the digital outputs of the ADC1173. When high, the outputs are in a high impedance state.
12	CLK		CMOS/TTL compatible digital clock Input. $V_{IN}$ is sampled on the falling edge of CLK input.
3 thru 10	D0-D7		Conversion data digital Output pins. D0 is the LSB, D7 is the MSB. Valid data is output just after the rising edge of the CLK input. These pins are enabled by bringing the $\overline{OE}$ pin low.
11, 13	$DV_{DD}$		Positive digital supply pin. Connect to a clean, quiet voltage source of +3V. $AV_{DD}$ and $DV_{DD}$ should have a common source and be separately bypassed with a 10 $\mu$ F capacitor and a 0.1 $\mu$ F ceramic chip capacitor. See Section 3.0 for more information.

## Pin Descriptions and Equivalent Circuits (Continued)

Pin No.	Symbol	Equivalent Circuit	Description
2, 24	DV <sub>SS</sub>		The ground return for the digital supply. AV <sub>SS</sub> and DV <sub>SS</sub> should be connected together close to the ADC1173.
14, 15, 18	AV <sub>DD</sub>		Positive analog supply pin. Connected to a clean, quiet voltage source of +3V. AV <sub>DD</sub> and DV <sub>DD</sub> should have a common source and be separately bypassed with a 10 $\mu$ F capacitor and a 0.1 $\mu$ F ceramic chip capacitor. See Section 3.0 for more information.
20, 21	AV <sub>SS</sub>		The ground return for the analog supply. AV <sub>SS</sub> and DV <sub>SS</sub> should be connected together close to the ADC1173 package.

**Absolute Maximum Ratings** (Note 1)

If Military/Aerospace specified devices are required, please contact the National Semiconductor Sales Office/Distributors for availability and specifications.

$V_{DD}$ , $DV_{DD}$	6.5V
Voltage on Any Pin	-0.3V to 6.5V
$V_{RT}$ , $V_{RB}$	$V_{DD}$ to $V_{SS}$
CLK, $\overline{OE}$ Voltage	-0.5 to ( $V_{DD} + 0.5V$ )
Digital Output Voltage	$DV_{SS}$ to $DV_{DD}$
Input Current (Note 3)	$\pm 25mA$
Package Input Current (Note 3)	$\pm 50mA$
Package Dissipation at 25°C	(Note 4)
ESD Susceptibility (Note 5)	
Human Body Model	2000V
Machine Model	200V
Soldering Temp., Infrared, 10 sec. (Note 6)	300°C
Storage Temperature	-65°C to +150°C

**Operating Ratings** (Notes 1, 2)

Temperature Range	$-40^{\circ}C \leq T_A \leq +75^{\circ}C$
$V_{DD}$ , $DV_{DD}$	+2.7V to +3.6V
$ AV_{SS} - DV_{SS} $	0V to 100 mV
$V_{RT}$	1.0V to $V_{DD}$
$V_{RB}$	0V to 2.0V
$V_{RT} - V_{RB}$	1.0V to 2.8V
$V_{IN}$ Voltage Range	$V_{RB}$ to $V_{RT}$

**Converter Electrical Characteristics**

The following specifications apply for  $V_{DD} = DV_{DD} = +3.0V_{DC}$ ,  $\overline{OE} = 0V$ ,  $V_{RT} = +2.0V$ ,  $V_{RB} = 0V$ ,  $C_L = 20 pF$ ,  $f_{CLK} = 15MHz$  at 50% duty cycle. **Boldface limits apply for  $T_A = T_{MIN}$  to  $T_{MAX}$** ; all other limits  $T_A = 25^{\circ}C$  (Notes 7, 8)

Symbol	Parameter	Conditions	Typical (Note 9)	Limits	Units
<b>DC Accuracy</b>					
INL	Integral Non Linearity		$\pm 0.5$	<b><math>\pm 1.3</math></b>	LSB( max)
DNL	Differential Non Linearity		$\pm 0.4$	<b><math>\pm 0.85</math></b>	LSB( max)
	Missing Codes			<b>0</b>	(max)
$E_{OT}$	Top Offset		-12		mV
$E_{OB}$	Bottom Offset		+1.0		mV
<b>Video Accuracy</b>					
DP	Differential Phase Error	$f_{in} = 3.58 MHz$ sine wave	0.5		Degree
DG	Differential Gain Error	$f_{in} = 3.58 MHz$ sine wave	1.5		%
<b>Analog Input and Reference Characteristics</b>					
$V_{IN}$	Input Range		2.0	$V_{RB}$ $V_{RT}$	V(min) V(max)
$C_{IN}$	$V_{IN}$ Input Capacitance	$V_{IN} = 1.5V + 0.7V_{rms}$	(CLK LOW)	4	pF
			(CLK HIGH)	11	
$R_{IN}$	Input Resistance		>1		M $\Omega$
BW	Analog Input Bandwidth		120		MHz
$R_{RT}$	Top Reference Resistor		360		$\Omega$
$R_{REF}$	Reference Ladder Resistance	$V_{RT}$ to $V_{RB}$		300	$\Omega$ (min)
				200 400	$\Omega$ (max)
$R_{RB}$	Bottom Reference Resistor		90		$\Omega$
$I_{REF}$	Reference Ladder Current	$V_{RT} = V_{RTS}$ , $V_{RB} = V_{RBS}$	4.2		mA
		$V_{RT} = V_{RTS}$ , $V_{RB} = AV_{SS}$	4.8		mA
$V_{RT}$	Reference Top Self Bias Voltage	$V_{RT}$ connected to $V_{RTS}$	1.56	<b>1.45</b>	V(min)
		$V_{RB}$ connected to $V_{RBS}$		<b>1.65</b>	V(max)
$V_{RB}$	Reference Bottom Self Bias Voltage	$V_{RT}$ connected to $V_{RTS}$	0.36	<b>0.32</b>	V(min)
		$V_{RB}$ connected to $V_{RBS}$		<b>0.40</b>	V(max)

## Converter Electrical Characteristics (Continued)

The following specifications apply for  $AV_{DD} = DV_{DD} = +3.0V_{DC}$ ,  $\overline{OE} = 0V$ ,  $V_{RT} = +2.0V$ ,  $V_{RB} = 0V$ ,  $C_L = 20$  pF,  $f_{CLK} = 15$  MHz at 50% duty cycle. **Boldface limits apply for  $T_A = T_{MIN}$  to  $T_{MAX}$** ; all other limits  $T_A = 25^\circ C$  (Notes 7, 8)

Symbol	Parameter	Conditions	Typical (Note 9)	Limits	Units
$V_{RTS} - V_{RBS}$	Self Bias Voltage Delta	$V_{RT}$ connected to $V_{RTS}$ , $V_{RB}$ connected to $V_{RBS}$	1.2	<b>1.1</b> <b>1.3</b>	$\mu A_{min}$ $\mu A_{max}$
		$V_{RT}$ connected to $V_{RTS}$ , $V_{RB}$ connected to $V_{SS}$	1.38		V
$V_{RT} - V_{RB}$	Reference Voltage Delta		2	<b>1.0</b> <b><math>V_A</math></b>	V(min) V(max)
<b>Power Supply Characteristics</b>					
$I_{A_{DD}}$	Analog Supply Current	$DV_{DD} = AV_{DD} = 3.6V$	6.8		mA
$I_{D_{DD}}$	Digital Supply Current	$DV_{DD} = AV_{DD} = 3.6V$	2.3		mA
$I_{AV_{DD}} + I_{DV_{DD}}$	Total Operating Current	$DV_{DD} = AV_{DD} = 3.6V$ ,	9.1	<b>11.4</b>	mA
		$DV_{DD} = AV_{DD} = 3.6V$ , CLK Low (Note 10)	5.8		mA
	Power Consumption	$DV_{DD} = AV_{DD} = 3.6V$	33	<b>41</b>	mW
<b>CLK, <math>\overline{OE}</math> Digital Input Characteristics</b>					
$V_{IH}$	Logical High Input Voltage	$DV_{DD} = AV_{DD} = 3.6V$		<b>2.2</b>	V (min)
$V_{IL}$	Logical Low Input Voltage	$DV_{DD} = AV_{DD} = 3.6V$		<b>0.8</b>	V (max)
$I_{IH}$	Logical High Input Current	$V_{IH} = DV_{DD} = AV_{DD} = 3.6V$	5		$\mu A$
$I_{IL}$	Logic Low Input Current	$V_{IL} = 0V$ , $DV_{DD} = AV_{DD} = 3.6V$	-5		$\mu A$
$C_{IN}$	Logic Input Capacitance		5		pF
<b>Digital Output Characteristics</b>					
$V_{OH}$	High Level Output Voltage	$DV_{DD} = 2.7V$ , $I_{OH} = -360\mu A$	2.4		V(min)
		$DV_{DD} = 2.7V$ , $I_{OH} = -1.1mA$	2.1	<b>1.9</b>	V(min)
$V_{OL}$	Low Level Output Voltage	$DV_{DD} = 2.7V$ , $I_{OL} = 1.6mA$	0.32	<b>0.6</b>	V(max)
$I_{OZH}$ , $I_{OZL}$	TRI-STATE® Leakage Current	$DV_{DD} = 3.6V$ , $\overline{OE} = DV_{DD}$ , $V_{OL} = 0V$ or $V_{OH} = DV_{DD}$	$\pm 20$		$\mu A$
<b>AC Electrical Characteristics</b>					
$f_{C1}$	Maximum Conversion Rate		20	<b>15</b>	MHz(min)
$f_{C2}$	Minimum Conversion Rate		1		MHz
$t_{OD-0}$	Output Delay	CLK high to low data valid	28		ns(max)
$t_{OD-1}$	Output Delay	CLK low to high data valid	24		ns(max)
	Pipeline Delay (Latency)		2.5		Clock Cycles
$t_{DS}$	Sampling (Aperture) Delay	CLK low to acquisition of data	3		ns
$t_{AJ}$	Aperture Jitter		30		ps rms
$t_{OH}$	Output Hold Time	CLK high to data invalid	15		ns
$t_{EN}$	$\overline{OE}$ Low to Data Valid	Loaded as in Figure 2	22		ns
$t_{DIS}$	$\overline{OE}$ High to High Z State	Loaded as in Figure 2	12		ns
ENOB	Effective Number of Bits	$f_{IN} = 1.31$ MHz	7.7	<b>7.0</b>	Bits (min)
		$f_{IN} = 3.58$ MHz	7.6		
		$f_{IN} = 7.5$ MHz	7.4		
SINAD	Signal-to- Noise & Distortion	$f_{IN} = 1.31$ MHz	49	<b>43</b>	dB(min)
		$f_{IN} = 3.58$ MHz	47.7		
		$f_{IN} = 7.5$ MHz	46.5		
SNR	Signal-to-Noise Ratio	$f_{IN} = 1.31$ MHz	49	<b>44</b>	dB(min)
		$f_{IN} = 3.58$ MHz	48.7		
		$f_{IN} = 7.5$ MHz	48.0		

## Converter Electrical Characteristics (Continued)

The following specifications apply for  $AV_{DD} = DV_{DD} = +3.0V_{DC}$ ,  $\overline{OE} = 0V$ ,  $V_{RT} = +2.0V$ ,  $V_{RB} = 0V$ ,  $C_L = 20\text{ pF}$ ,  $f_{CLK} = 15\text{ MHz}$  at 50% duty cycle. **Boldface limits apply for  $T_A = T_{MIN}$  to  $T_{MAX}$** ; all other limits  $T_A = 25^\circ\text{C}$  (Notes 7, 8)

Symbol	Parameter	Conditions	Typical (Note 9)	Limits	Units
SFDR	Spurious Free Dynamic Range	$f_{IN} = 1.31\text{ MHz}$	65		dB
		$f_{IN} = 3.58\text{ MHz}$	55		
		$f_{IN} = 7.5\text{ MHz}$	51		
THD	Total Harmonic Distortion	$f_{IN} = 1.31\text{ MHz}$	-62		dB
		$f_{IN} = 3.58\text{ MHz}$	-54		
		$f_{IN} = 7.5\text{ MHz}$	-51		

**Note 1:** Absolute Maximum Ratings indicate limits beyond which damage to the device may occur. Operating Ratings indicate conditions for which the device is functional, but do not guarantee specific performance limits. For guaranteed specifications and test conditions, see the Electrical Characteristics. The guaranteed specifications apply only for the test conditions listed. Some performance characteristics may degrade when the device is not operated under the listed test conditions.

**Note 2:** All voltages are measured with respect to  $GND = AV_{SS} = DV_{SS} = 0V$ , unless otherwise specified.

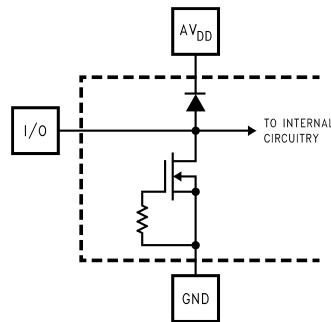
**Note 3:** When the input voltage at any pin exceeds the power supplies (that is, less than  $AV_{SS}$  or  $DV_{SS}$ , or greater than  $AV_{DD}$  or  $DV_{DD}$ ), the current at that pin should be limited to 25 mA. The 50 mA maximum package input current rating limits the number of pins that can safely exceed the power supplies with an input current of 25 mA to two.

**Note 4:** The absolute maximum junction temperatures ( $T_{Jmax}$ ) for this device is  $150^\circ\text{C}$ . The maximum allowable power dissipation is dictated by  $T_{Jmax}$ , the junction-to-ambient thermal resistance  $\theta_{JA}$ , and the ambient temperature,  $T_A$ , and can be calculated using the formula  $P_{DMAX} = (T_{Jmax} - T_A) / \theta_{JA}$ . In the 24-pin TSSOP,  $\theta_{JA}$  is  $92^\circ\text{C/W}$ , so  $P_{DMAX} = 1,358\text{ mW}$  at  $25^\circ\text{C}$  and  $815\text{ mW}$  at the maximum operating ambient temperature of  $75^\circ\text{C}$ . (Typical thermal resistance,  $\theta_{JA}$ , of this part is  $98^\circ\text{C/W}$  for the EIAJ SOIC). Note that the power dissipation of this device under normal operation will typically be about  $49\text{ mW}$  ( $33\text{ mW}$  quiescent power +  $13\text{ mW}$  reference ladder power +  $3\text{ mW}$  due to 1 TTL load on each digital output). The values for maximum power dissipation listed above will be reached only when the ADC1173 is operated in a severe fault condition (e.g. when input or output pins are driven beyond the power supply voltages, or the power supply polarity is reversed). Obviously, such conditions should always be avoided.

**Note 5:** Human body model is  $100\text{ pF}$  capacitor discharged through a  $1.5\text{ k}\Omega$  resistor. Machine model is  $220\text{ pf}$  discharged through  $ZERO\ \Omega$ .

**Note 6:** See AN450, "Surface Mounting Methods and Their Effect on Product Reliability", or the section entitled "Surface Mount" found in any post 1986 National Semiconductor Linear Data Book, for other methods of soldering surface mount devices.

**Note 7:** The analog inputs are protected as shown below. Input voltage magnitudes up to  $6.5V$  or to  $500\text{ mV}$  below  $GND$  will not damage this device. However, errors in the A/D conversion can occur if the input goes above  $V_{DD}$  or below  $GND$  by more than  $50\text{ mV}$ . As an example, if  $AV_{DD}$  is  $2.7V_{DC}$ , the full-scale input voltage must be  $\leq 2.75V_{DC}$  to ensure accurate conversions.



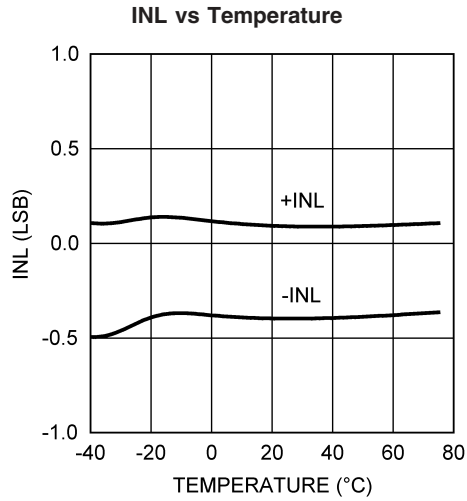
10089010

**Note 8:** To guarantee accuracy, it is required that  $AV_{DD}$  and  $DV_{DD}$  be well bypassed. Each supply pin must be decoupled with separate bypass capacitors.

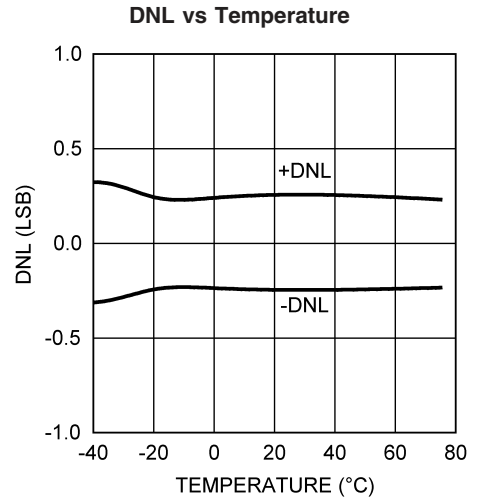
**Note 9:** Typical figures are at  $T_J = 25^\circ\text{C}$ , and represent most likely parametric norms. Test limits are guaranteed to National's AOQL (Average Outgoing Quality Level).

**Note 10:** At least two clock cycles must be presented to the ADC1173 after power up. See Section 4.0 for details.

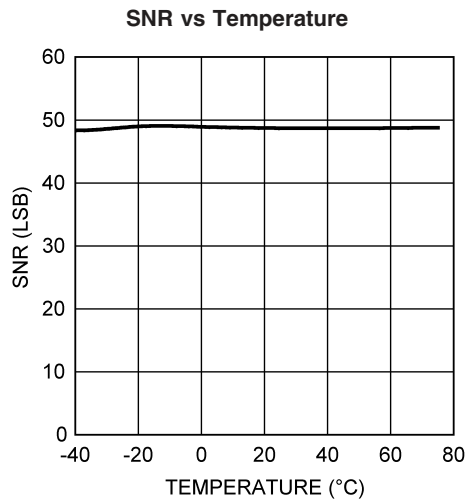
# Typical Performance Characteristics



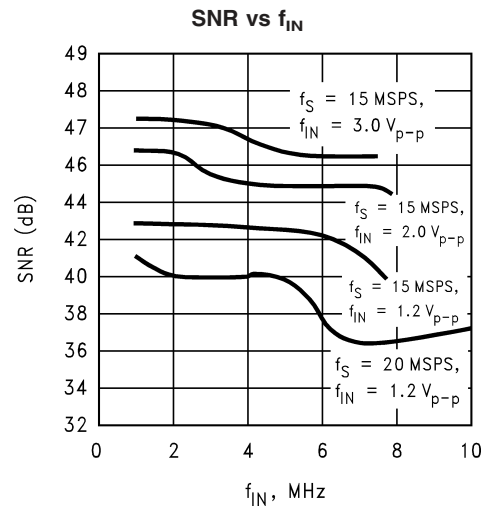
10089020



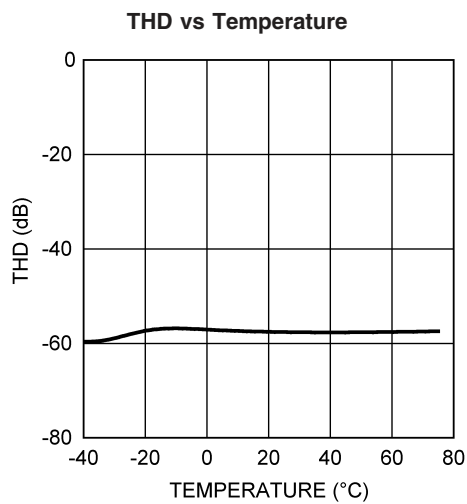
10089021



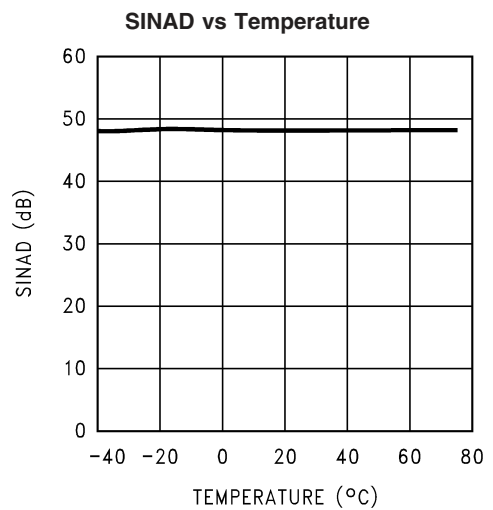
10089022



10089033

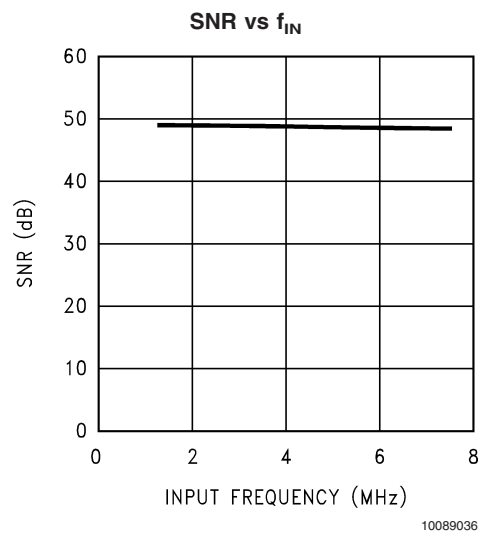
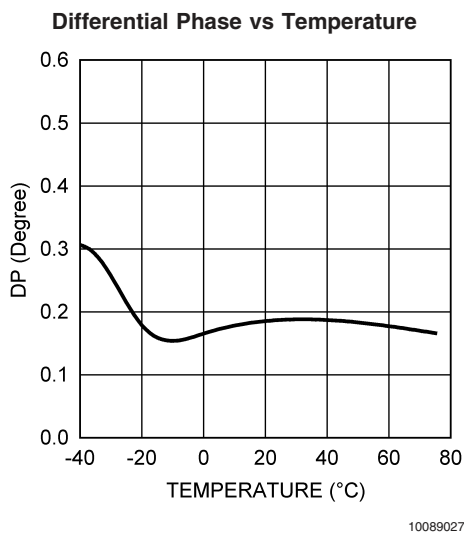
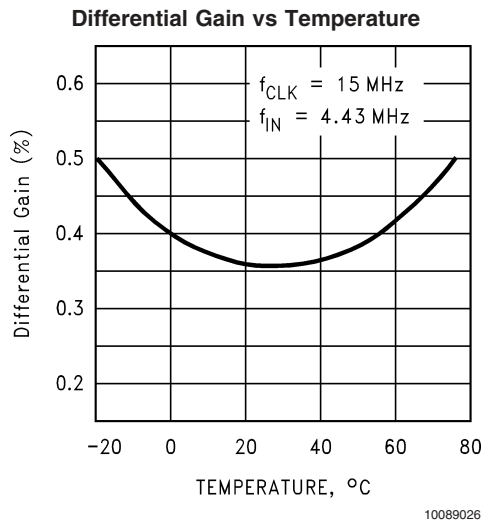
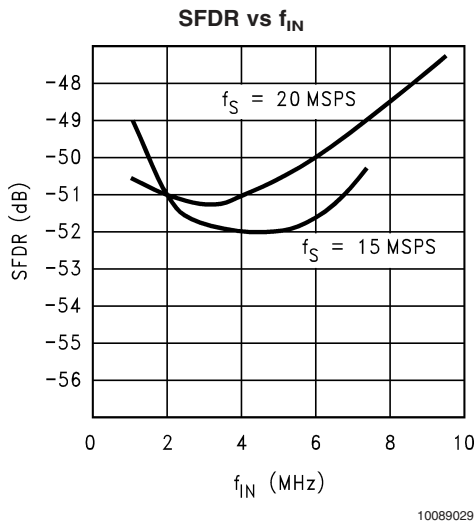
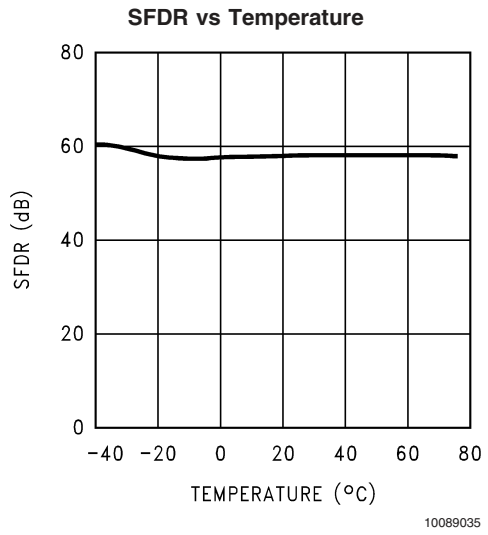
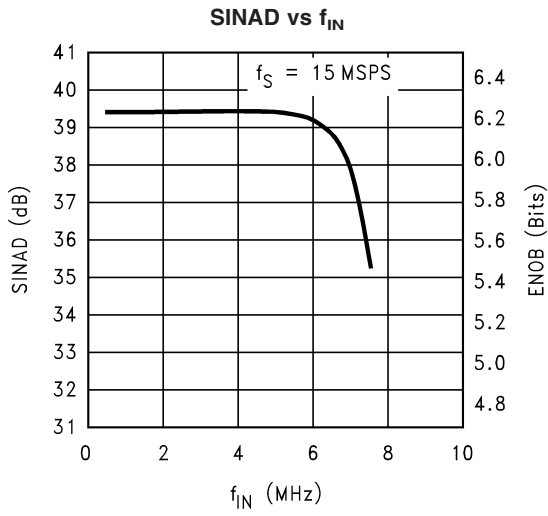


10089023

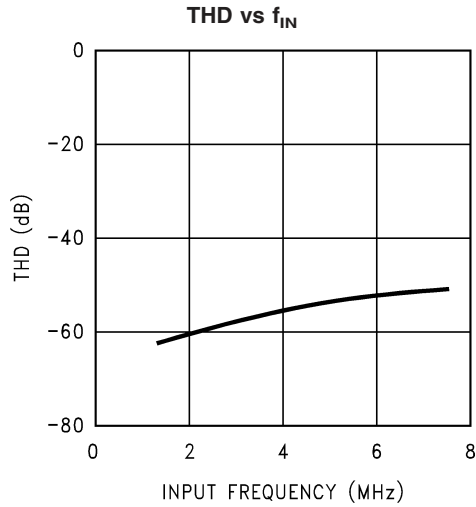


10089034

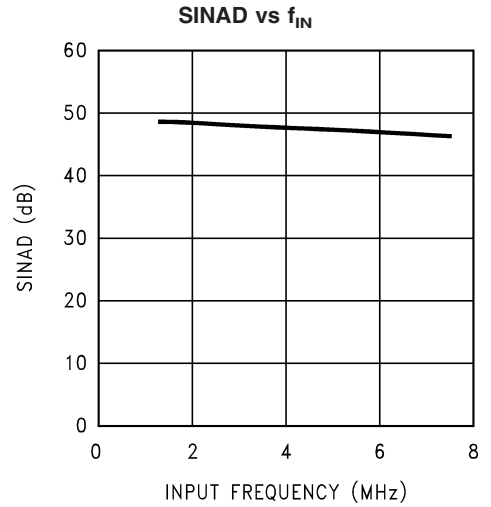
Typical Performance Characteristics (Continued)



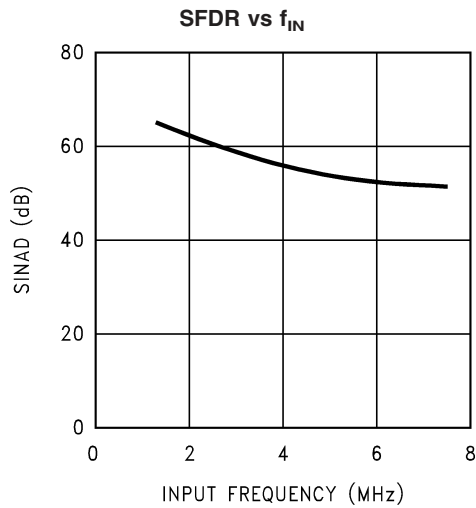
Typical Performance Characteristics (Continued)



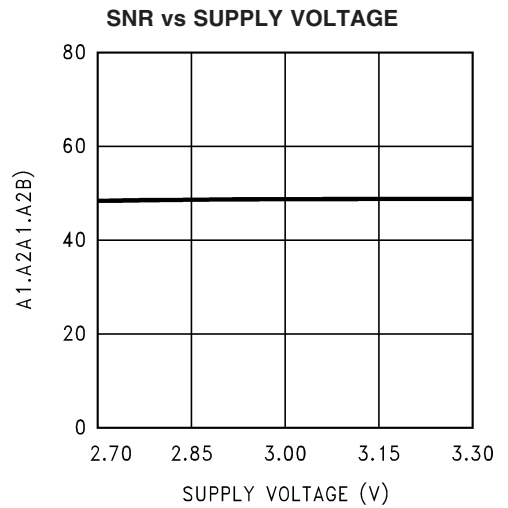
10089037



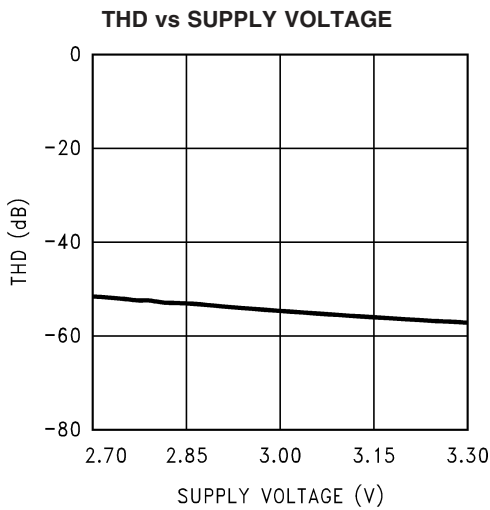
10089038



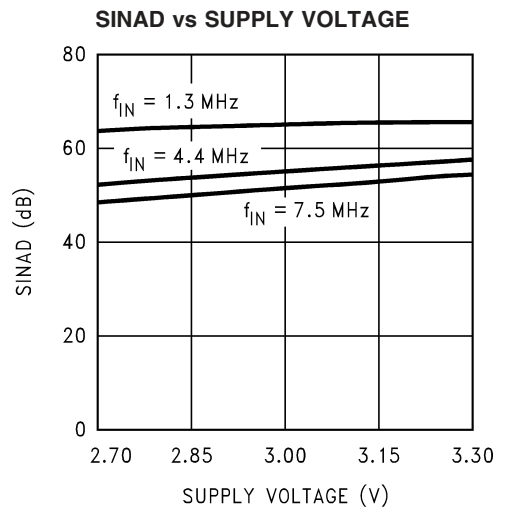
10089039



10089040

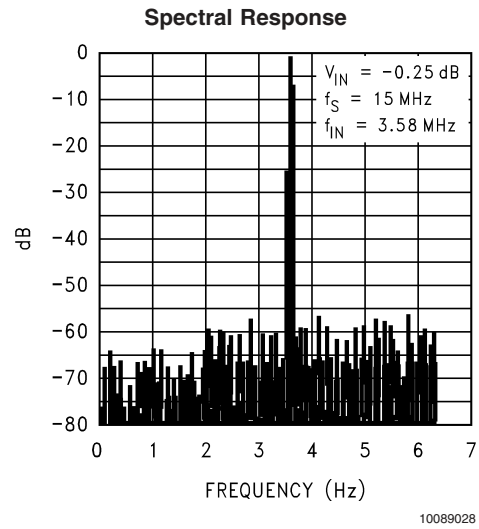
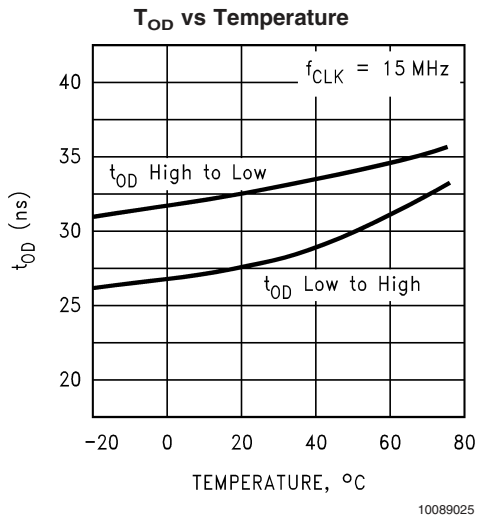
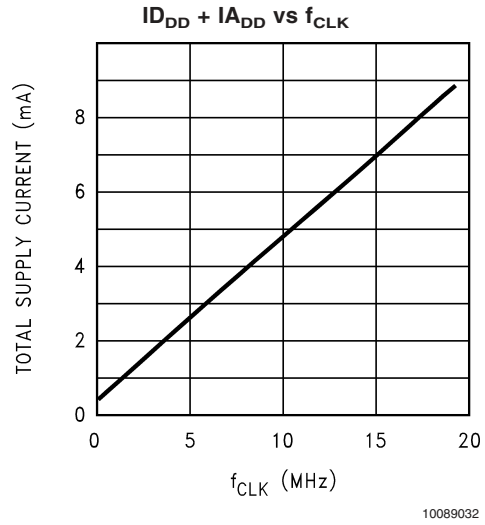
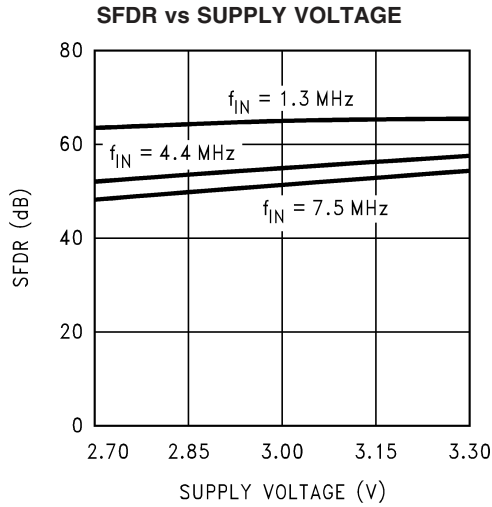


10089041



10089042

Typical Performance Characteristics (Continued)



## Specification Definitions

**ANALOG INPUT BANDWIDTH** is a measure of the frequency at which the reconstructed output fundamental drops 3 dB below its low frequency value for a full scale input. The test is performed with  $f_{IN}$  equal to 100 kHz plus integer multiples of  $f_{CLK}$ . The input frequency at which the output is -3 dB relative to the low frequency input signal is the full power bandwidth.

**APERTURE JITTER** is the time uncertainty of the sampling point ( $t_{DS}$ ), or the range of variation in the sampling delay.

**BOTTOM OFFSET** is the difference between the input voltage that just causes the output code to transition to the first code and the negative reference voltage. Bottom offset is defined as  $E_{OB} = V_{ZT} - V_{RB}$ , where  $V_{ZT}$  is the first code transition input voltage. Note that this is different from the normal Zero Scale Error.

**DIFFERENTIAL GAIN ERROR** is the percentage difference between the output amplitudes of a high frequency reconstructed sine wave at two different dc levels.

**DIFFERENTIAL NON-LINEARITY (DNL)** is the measure of the maximum deviation from the ideal step size of 1 LSB.

**DIFFERENTIAL PHASE ERROR** is the difference in the output phase of a reconstructed small signal sine wave at two different dc levels.

**EFFECTIVE NUMBER OF BITS (ENOB, or EFFECTIVE BITS)** is another method of specifying Signal-to-Noise and Distortion Ratio, or SINAD. ENOB is defined as  $(SINAD - 1.76) / 6.02$  and says that the converter is equivalent to a perfect ADC of this (ENOB) number of bits.

**INTEGRAL NON-LINEARITY (INL)** is a measure of the deviation of each individual code from a line drawn from zero scale ( $1/2$ LSB below the first code transition) through positive full scale ( $1/2$ LSB above the last code transition). The deviation of any given code from this straight line is measured from the center of that code value. The end point test method is used.

**OUTPUT DELAY** is the time delay after the rising edge of the input clock before the data update is present at the output pins.

**OUTPUT HOLD TIME** is the length of time that the output data is valid after the rise of the input clock.

**PIPELINE DELAY (LATENCY)** is the number of clock cycles between initiation of conversion and the availability of that conversion result at the output. New data is available at every clock cycle, but the data lags the conversion by the pipeline delay.

**SAMPLING (APERTURE) DELAY** is that time required after the fall of the clock input for the sampling switch to open. The Sample/Hold circuit effectively stops capturing the input signal and goes into the "hold" mode  $t_{DS}$  after the clock goes low.

**SIGNAL TO NOISE RATIO (SNR)** is the ratio of the rms value of the input signal to the rms value of the other spectral components below one-half the sampling frequency, not including harmonics or dc.

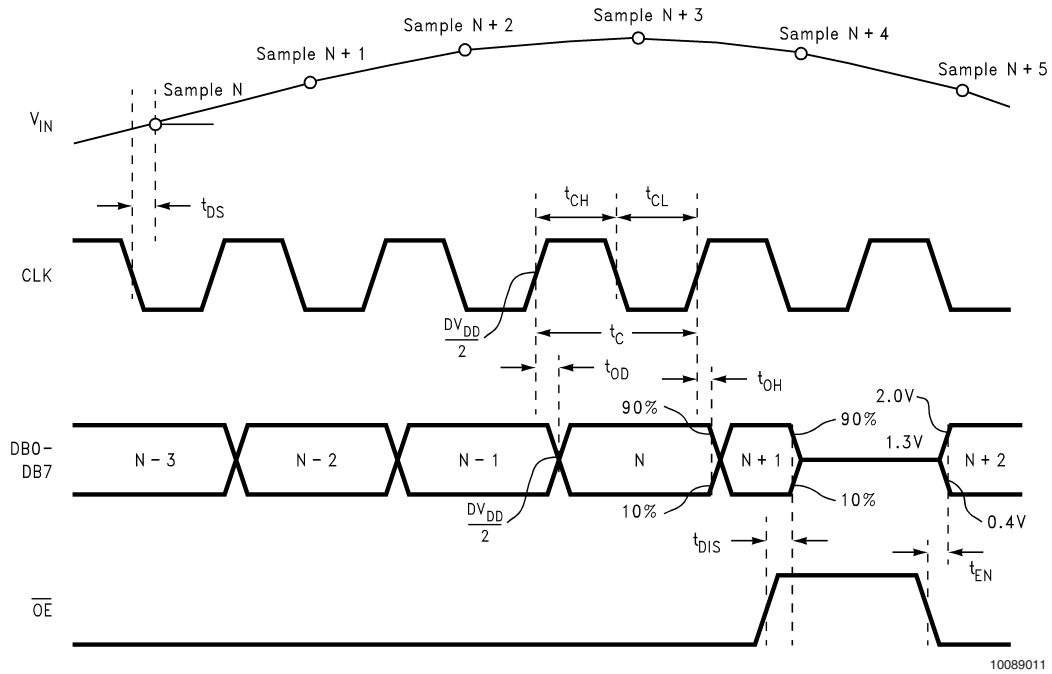
**SIGNAL TO NOISE PLUS DISTORTION (S/(N+D) or SINAD)** is the ratio of the rms value of the input signal to the rms value of all of the other spectral components below half the clock frequency, including harmonics but excluding dc.

**SPURIOUS FREE DYNAMIC RANGE (SFDR)** is the difference, expressed in dB, between the rms values of the input signal and the peak spurious signal, where a spurious signal is any signal present in the output spectrum that is not present at the input.

**TOP OFFSET** is the difference between the positive reference voltage and the input voltage that just causes the output code to transition to full scale and is defined as  $E_{OT} = V_{FT} - V_{RT}$ . Where  $V_{FT}$  is the full scale transition input voltage. Note that this is different from the normal Full Scale Error.

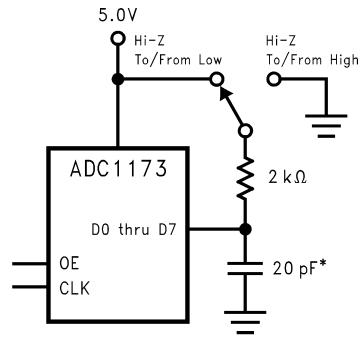
**TOTAL HARMONIC DISTORTION (THD)** is the ratio of the rms total of the first six harmonic components, to the rms value of the input signal.

# Timing Diagram



10089011

FIGURE 1. ADC1173 Timing Diagram



\* Includes stray and distributed capacitance

10089012

FIGURE 2.  $t_{EN}$ ,  $t_{DIS}$  Test Circuit

## Functional Description

The ADC1173 uses a new, unique architecture to achieve 7.4 effective bits at and maintains superior dynamic performance up to  $\frac{1}{2}$  the clock frequency.

The analog signal at  $V_{IN}$  that is within the voltage range set by  $V_{RT}$  and  $V_{RB}$  are digitized to eight bits at up to 20 MSPS. Input voltages below  $V_{RB}$  will cause the output word to consist of all zeroes. Input voltages above  $V_{RT}$  will cause the output word to consist of all ones.  $V_{RT}$  has a range of 1.0 Volt to the analog supply voltage,  $AV_{DD}$ , while  $V_{RB}$  has a range of 0 to 2.0 Volts.  $V_{RT}$  should always be at least 1.0 Volt more positive than  $V_{RB}$ .

If  $V_{RT}$  and  $V_{RTS}$  are connected together and  $V_{RB}$  and  $V_{RBS}$  are connected together, the nominal values of  $V_{RT}$  and  $V_{RB}$  are 1.56V and 0.36V, respectively. If  $V_{RT}$  and  $V_{RTS}$  are connected together and  $V_{RB}$  is grounded, the nominal value of  $V_{RT}$  is 1.38V.

Data is acquired at the falling edge of the clock and the digital equivalent of the data is available at the digital outputs 2.5 clock cycles plus  $t_{OD}$  later. The ADC1173 will convert as long as the clock signal is present at pin 12. The Output Enable pin  $\overline{OE}$ , when low, enables the output pins. The digital outputs are in the high impedance state when the  $\overline{OE}$  pin is high.

## Applications Information

### 1.0 THE ANALOG INPUT

The analog input of the ADC1173 is a switch followed by an integrator. The input capacitance changes with the clock level, appearing as 4 pF when the clock is low, and 11 pF when the clock is high. Since a dynamic capacitance is more difficult to drive than a fixed capacitance, choose an amplifier that can drive this type of load. The LMH6702, LM6152, LM6154, LM6181 and LM6182 have been found to be excellent devices for driving the ADC1173. Do not drive the input beyond the supply rails.

*Figure 3* shows an example of an input circuit using the LM6181. This circuit has both gain and offset adjustments. If you desire to eliminate these adjustments, you should reduce the signal swing to avoid clipping at the ADC1173 output that can result from normal tolerances of all system components. With no adjustments, the nominal value for the amplifier feedback resistor is 510 $\Omega$  and the 5.1k resistor at the inverting input should be changed to 860 $\Omega$  and returned to +3V rather than to the Offset Adjust potentiometer.

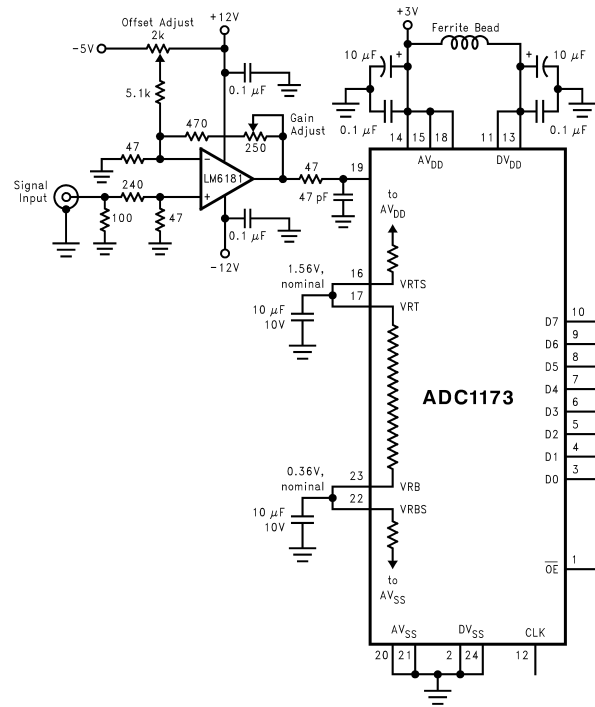
Driving the analog input with input signals up to 2.8V<sub>P-P</sub> will result in normal behavior where voltages above  $V_{RT}$  will result in a code of FFh and input voltages below  $V_{RB}$  will result in an output code of zero. Input signals above 2.8V<sub>P-P</sub> may result in odd behavior where the output code is not FFh when the input exceeds  $V_{RT}$ .

### 2.0 REFERENCE INPUTS

The reference inputs  $V_{RT}$  (Reference Top) and  $V_{RB}$  (Reference Bottom) are the top and bottom of the reference ladder. Input signals between these two voltages will be digitized to 8 bits. External voltages applied to the reference input pins should be within the range specified in the Operating Ratings table (1.0V to  $AV_{DD}$  for  $V_{RT}$  and 0V to ( $AV_{DD} - 1.0V$ ) for  $V_{RB}$ ). Any device used to drive the reference pins should be able to source sufficient current into the  $V_{RT}$  pin and sink sufficient current from the  $V_{RB}$  pin.

The reference ladder can be self-biased by connecting  $V_{RT}$  to  $V_{RTS}$  and connecting  $V_{RB}$  to  $V_{RBS}$  to provide top and bottom reference voltages of approximately 1.56V and 0.36V, respectively, with  $V_{CC} = 3.0V$ . This connection is shown in *Figure 3*. If  $V_{RT}$  and  $V_{RTS}$  are tied together, but  $V_{RB}$  is tied to analog ground, a top reference voltage of approximately 1.38V is generated. The top and bottom of the ladder should be bypassed with 10 $\mu$ F tantalum capacitors located close to the reference pins.

## Applications Information (Continued)



10089013

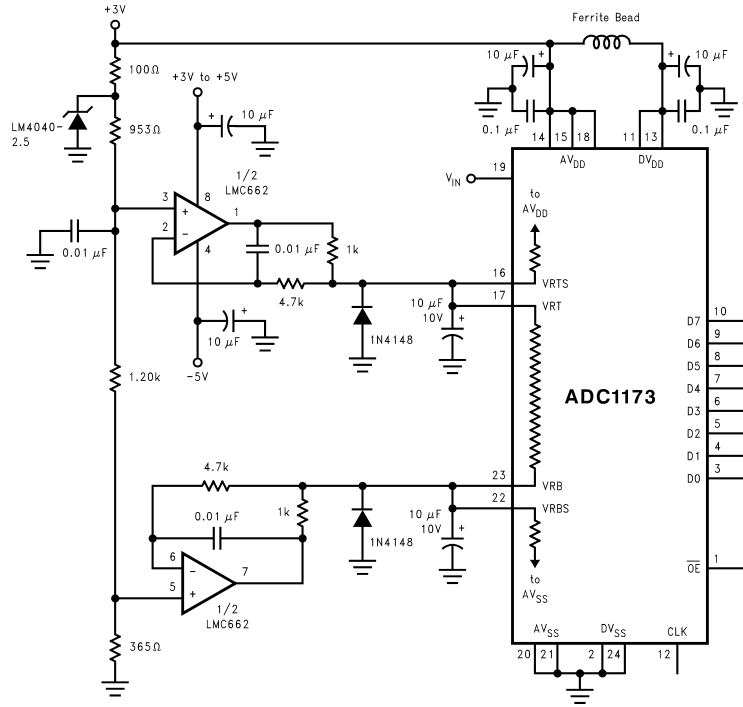
**FIGURE 3. Simple, Low Component Count, Self-Bias Reference application. Because of resistor tolerances, the reference voltages can vary by as much as 6%. Choose an amplifier that can drive a dynamic capacitance (see text).**

The reference self-bias circuit of *Figure 3* is very simple and performance is adequate for many applications. Superior performance can generally be achieved by driving the reference pins with a low impedance source.

By forcing a little current into or out of the top and bottom of the ladder, as shown in *Figure 4*, the top and bottom reference voltages can be trimmed. The resistive divider at the

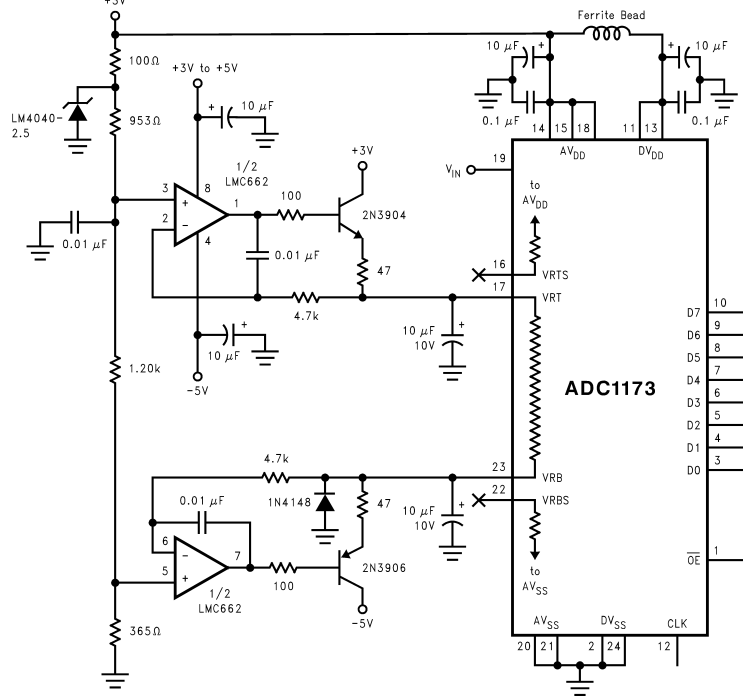
amplifier inputs can be replaced with potentiometers. The LMC662 amplifier shown was chosen for its low offset voltage and low cost. Note that a negative power supply is needed for these amplifiers as their outputs may be required to go slightly negative to force the required reference voltages.

Applications Information (Continued)



10089014

FIGURE 4. Better defining the ADC Reference Voltage. Self-bias is still used, but the reference voltages are trimmed by providing a small trim current with the operational amplifiers.



10089015

FIGURE 5. Driving the reference to force desired values requires driving with a low impedance source, provided by the transistors. Note that pins 16 and 22 are not connected.

## Applications Information (Continued)

If reference voltages are desired that are more than a few tens of millivolts from the self-bias values, the circuit of *Figure 5* will allow forcing the reference voltages to whatever levels are desired. This circuit provides the best performance because of the low source impedance of the transistors. Note that the  $V_{RTS}$  and  $V_{RBS}$  pins are left floating.

$V_{RT}$  can be anywhere between  $V_{RB} + 1.0V$  and the analog supply voltage, and  $V_{RB}$  can be anywhere between ground and  $1.0V$  below  $V_{RT}$ . To minimize noise effects and ensure accurate conversions, the total reference voltage range ( $V_{RT} - V_{RB}$ ) should be a minimum of  $1.0V$  and a maximum of about  $V_A$ . Best performance can be realized with  $V_{RT} = 1.56$  and  $V_{RB} = 0.36V$ .

### 3.0 POWER SUPPLY CONSIDERATIONS

Many A/D converters draw sufficient transient current to corrupt their own power supplies if not adequately bypassed. A  $10\mu F$  tantalum or aluminum electrolytic capacitor should be placed within an inch (2.5 centimeters) of the A/D power pins, with a  $0.1\mu F$  ceramic chip capacitor placed as close as possible to the converter's power supply pins. Leadless chip capacitors are preferred because they have low lead inductance.

While a single voltage source should be used for the analog and digital supplies of the ADC1173, these supply pins should be well isolated from each other to prevent any digital noise from being coupled to the analog power pins. A 47 Ohm resistor is recommended between the analog and digital supply lines, with a ceramic capacitor close to the analog supply pin. Avoid inductive components in the analog supply line.

The converter digital supply should **not** be the supply that is used for other digital circuitry on the board. It should be the same supply used for the A/D analog supply.

As is the case with all high speed converters, the ADC1173 should be assumed to have little power supply rejection, especially when self-biasing is used by connecting  $V_{RT}$  and  $V_{RTS}$  together.

No pin should ever have a voltage on it that is in excess of the supply voltages or below ground, not even on a transient basis. This can be a problem upon application of power to a circuit. Be sure that the supplies to circuits driving the CLK,  $\overline{OE}$ , analog input and reference pins do not come up any faster than does the voltage at the ADC1173 power pins.

### 4.0 THE ADC1173 CLOCK

Although the ADC1173 is tested and its performance is guaranteed with a 15MHz clock, it typically will function with clock frequencies from 1MHz to 20MHz.

If continuous conversions are not required, power consumption can be reduced somewhat by stopping the clock at a logic low when the ADC1173 is not being used. This reduces the current drain in the ADC1173's digital circuitry from a typical value of 2.3mA to about  $100\mu A$ .

Note that powering up the ADC1173 with the clock stopped may not save power, as it will result in an increased current flow (by as much as 170%) in the reference ladder. In some cases, this may increase the ladder current above the specified limit. Toggling the clock twice at 1MHz or higher and returning it to the low state will eliminate the excess ladder current.

An alternative power-saving technique is to power up the ADC1173 with the clock active, then halt the clock in the low state after two clock cycles. Stopping the clock in the high state is not recommended as a power-saving technique.

### 5.0 LAYOUT AND GROUNDING

Proper grounding and proper routing of all signals is essential to ensure accurate conversion. Separate analog and digital ground planes that are connected beneath the ADC1173 are required to meet data sheet limits. The analog and digital grounds may be in the same layer, but should be separated from each other. The analog and digital ground planes should **never** overlap each other.

Capacitive coupling between the typically noisy digital ground plane and the sensitive analog circuitry can lead to poor performance that may seem impossible to isolate and remedy. The solution is to keep the analog circuitry well separated from the digital circuitry and from the digital ground plane.

Digital circuits create substantial supply and ground transients. The logic noise thus generated could have significant impact upon system noise performance. The best logic family to use in systems with A/D converters is one which employs non-saturating transistor designs, or has low noise characteristics, such as the 74HC(T) and 74AC(T)Q families. Worst noise generators are logic families that draw the largest supply current transients during clock or signal edges, like the 74F and the 74AC(T) families. In general, slower logic families, such as 74LS and 74HC(T), will produce less high frequency noise than do high speed logic families, such as the 74F and 74AC(T) families.

Since digital switching transients are composed largely of high frequency components, total ground plane copper weight will have little effect upon the logic-generated noise. This is because of the skin effect. Total surface area is more important than is total ground plane volume.

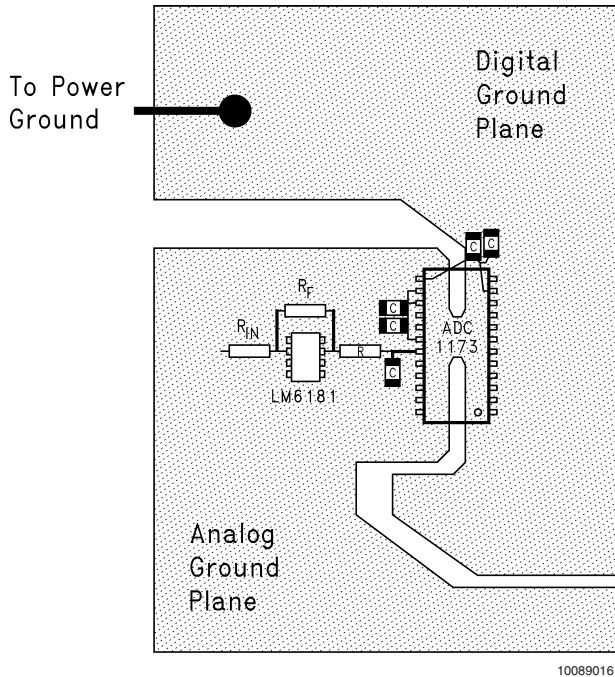
An effective way to control ground noise is by connecting the analog and digital ground planes together beneath the ADC with a copper trace that is very narrow (about 3/16 inch) compared with the rest of the ground plane. This narrowing beneath the converter provides a fairly high impedance to the high frequency components of the digital switching currents, directing them away from the analog pins. The relatively lower frequency analog ground currents do not see a significant impedance across this narrow ground connection.

Generally, analog and digital lines should cross each other at 90 degrees to avoid getting digital noise into the analog path. In video (high frequency) systems, however, avoid crossing analog and digital lines altogether. Clock lines should be isolated from ALL other lines, analog and digital. Even the generally accepted 90 degree crossing should be avoided as even a little coupling can cause problems at high frequencies. Best performance at high frequencies and at high resolution is obtained with a straight signal path.

Be especially careful with the layout of inductors. Mutual inductance can change the characteristics of the circuit in which they are used. Inductors should not be placed side by side, not even with just a small part of their bodies being beside each other.

The analog input should be isolated from noisy signal traces to avoid coupling of spurious signals into the input. Any external component (e.g., a filter capacitor) connected between the converter's input and ground should be connected to a very clean point in the analog ground return.

## Applications Information (Continued)



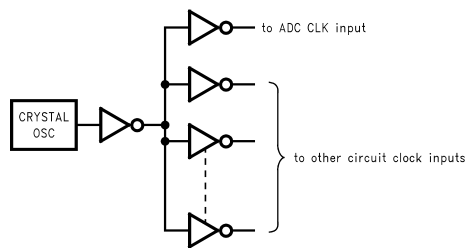
10089016

**FIGURE 6. Layout example showing separate analog and digital ground planes connected below the ADC1173.**

Figure 6 gives an example of a suitable layout. All analog circuitry (input amplifiers, filters, reference components, etc.) should be placed on or over the analog ground plane. All digital circuitry and I/O lines should be placed over the digital ground plane.

### 6.0 DYNAMIC PERFORMANCE

The ADC1173 is ac tested and its dynamic performance is guaranteed. To meet the published specifications, the clock source driving the CLK input must be free of jitter. For best ac performance, isolating the ADC clock from any digital circuitry should be done with adequate buffers, as with a clock tree. See Figure 7.



10089017

**FIGURE 7. Isolating the ADC clock from Digital Circuitry.**

It is good practice to keep the ADC clock line as short as possible and to keep it well away from any other signals. Other signals can introduce jitter into the clock signal.

### 7.0 COMMON APPLICATION PITFALLS

**Driving the inputs (analog or digital) beyond the power supply rails.** For proper operation, all inputs should not go more than 50mV below the ground pins or 50mV above the supply pins. Exceeding these limits on even a transient basis can cause faulty or erratic operation. It is not uncommon for high speed digital circuits (e.g., 74F and 74AC devices) to exhibit undershoot that goes more than a volt below ground. A resistor of 50Ω in series with the offending digital input will usually eliminate the problem.

Care should be taken not to overdrive the inputs of the ADC1173. Such practice may lead to conversion inaccuracies and even to device damage.

**Attempting to drive a high capacitance digital data bus.** The more capacitance the output drivers must charge for each conversion, the more instantaneous digital current is required from  $DV_{DD}$  and DGND. These large charging current spikes can couple into the analog section, degrading dynamic performance. Buffering the digital data outputs (with an 74ACQ541, for example) may be necessary if the data bus to be driven is heavily loaded. Dynamic performance can also be improved by adding 47Ω series resistors at each digital output, reducing the energy coupled back into the converter output pins.

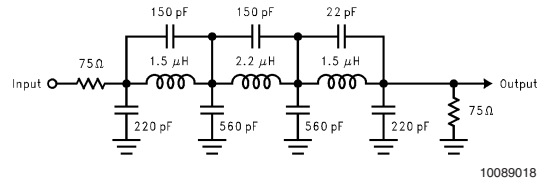
**Using an inadequate amplifier to drive the analog input.** As explained in Section 1.0, the capacitance seen at the input alternates between 4 pF and 11 pF with the clock. This dynamic capacitance is more difficult to drive than is a fixed capacitance, and should be considered when choosing a driving device. The LMH6702, LM6152, LM6154, LM6181 and LM6182 have been found to be excellent devices for driving the ADC1173 analog input.

**Driving the  $V_{RT}$  pin or the  $V_{RB}$  pin with devices that can not source or sink the current required by the ladder.** As mentioned in section 2.0, care should be taken to see that any driving devices can source sufficient current into the  $V_{RT}$  pin and sink sufficient current from the  $V_{RB}$  pin. If these pins are not driven with devices than can handle the required current, these reference pins will not be stable, resulting in a reduction of dynamic performance.

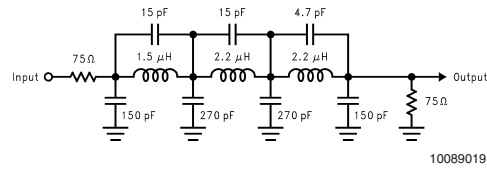
**Using a clock source with excessive jitter, using an excessively long clock signal trace, or having other signals coupled to the clock signal trace.** This will cause the sampling interval to vary, causing excessive output noise and a reduction in SNR performance. Simple gates with RC timing is generally inadequate as a clock source.

**Input test signal contains harmonic distortion that interferes with the measurement of dynamic signal to noise ratio.** Harmonic and other interfering signals can be removed by inserting a filter at the signal input. Suitable filters are shown in Figure 8 and Figure 9. The circuit of Figure 8 has cutoff of about 5.5 MHz and is suitable for input frequencies of 1 MHz to 5 MHz. The circuit of Figure 9 has a cutoff of about 11 MHz and is suitable for input frequencies of 5 MHz to 10 MHz. These filters should be driven by a generator of 75 Ohm source impedance and terminated with a 75 ohm resistor.

**Applications Information** (Continued)

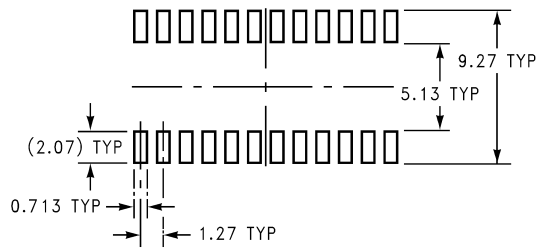
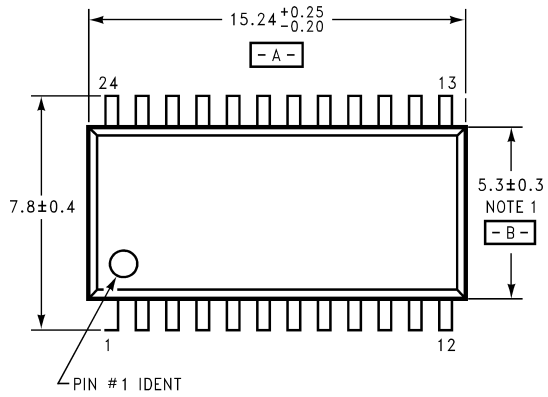


**FIGURE 8. 5.5 MHz Low Pass Filter to Eliminate Harmonics at the Signal Input.**

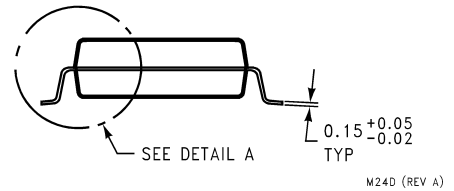
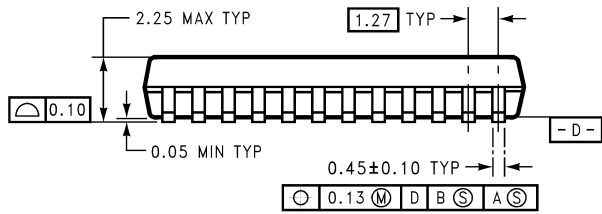
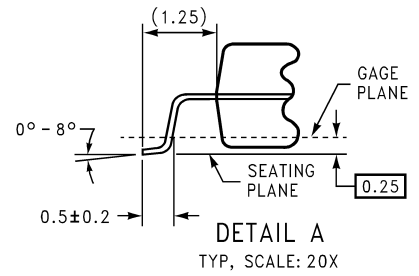


**FIGURE 9. 11 MHz Low Pass filter to eliminate harmonics at the signal input.  
Use at input frequencies of 5 MHz to 10 MHz**

**Physical Dimensions** inches (millimeters) unless otherwise noted

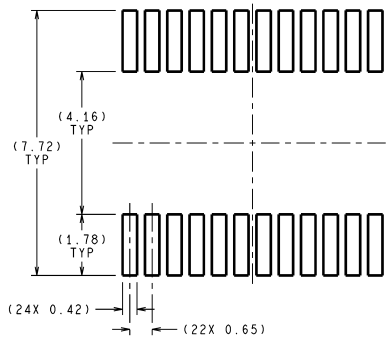
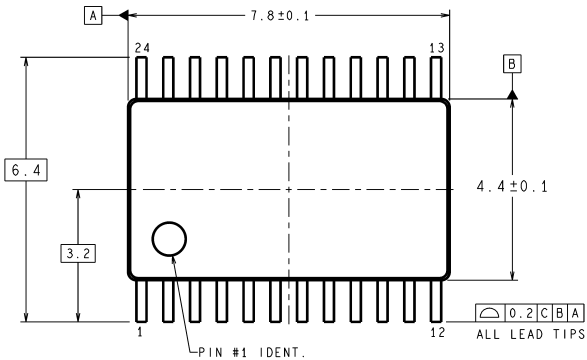


**LAND PATTERN RECOMMENDATION**

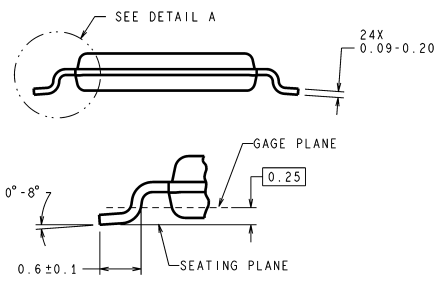
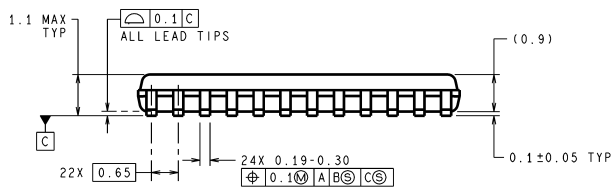


**24-Lead Package JM**  
**Ordering Number ADC1173CIJM**  
**NS Package Number M24D**

**Physical Dimensions** inches (millimeters) unless otherwise noted (Continued)



LAND PATTERN RECOMMENDATION



DETAIL A  
TYPICAL, SCALE: 20X

MTC24 (Rev D)

**24-Lead Package TC**  
**Ordering Number ADC1173CIMTC**  
**NS Package Number MTC24**

**LIFE SUPPORT POLICY**

NATIONAL'S PRODUCTS ARE NOT AUTHORIZED FOR USE AS CRITICAL COMPONENTS IN LIFE SUPPORT DEVICES OR SYSTEMS WITHOUT THE EXPRESS WRITTEN APPROVAL OF THE PRESIDENT AND GENERAL COUNSEL OF NATIONAL SEMICONDUCTOR CORPORATION. As used herein:

1. Life support devices or systems are devices or systems which, (a) are intended for surgical implant into the body, or (b) support or sustain life, and whose failure to perform when properly used in accordance with instructions for use provided in the labeling, can be reasonably expected to result in a significant injury to the user.
2. A critical component is any component of a life support device or system whose failure to perform can be reasonably expected to cause the failure of the life support device or system, or to affect its safety or effectiveness.



**National Semiconductor**  
**Americas Customer Support Center**  
Email: new.feedback@nsc.com  
Tel: 1-800-272-9959

**National Semiconductor**  
**Europe Customer Support Center**  
Fax: +49 (0) 180-530 85 86  
Email: europe.support@nsc.com  
Deutsch Tel: +49 (0) 69 9508 6208  
English Tel: +44 (0) 870 24 0 2171  
Français Tel: +33 (0) 1 41 91 8790

**National Semiconductor**  
**Asia Pacific Customer Support Center**  
Fax: +65-6250 4466  
Email: ap.support@nsc.com  
Tel: +65-6254 4466

**National Semiconductor**  
**Japan Customer Support Center**  
Fax: 81-3-5639-7507  
Email: jpn.feedback@nsc.com  
Tel: 81-3-5639-7560

www.national.com