

CLC428

Dual Wideband, Low-Noise, Voltage Feedback Op Amp

General Description

The CLC428 is a very high-speed dual op amp that offers a traditional voltage-feedback topology featuring unity-gain stability and slew-enhanced circuitry. The CLC428's ultra low noise and very low harmonic distortion combine to form a very wide dynamic-range op amp that operates from a single (5 to 12V) or dual ($\pm 5V$) power supply.

Each of the CLC428's closely matched channels provides a 160MHz unity-gain bandwidth with an ultra low input voltage noise density ($2nV/\sqrt{Hz}$). Very low 2nd/3rd harmonic distortion ($-62/-72dBc$) as well as high channel-to-channel isolation ($-62dB$) make the CLC428 a perfect wide dynamic-range amplifier for matched I/Q channels.

With its fast and accurate settling (16ns to 0.1%), the CLC428 is also a excellent choice for wide-dynamic range, anti-aliasing filters to buffer the inputs of hi-resolution analog-to-digital converters. Combining the CLC428's two tightly-matched amplifiers in a single eight-pin SOIC reduces cost and board space for many composite amplifier applications such as active filters, differential line drivers/receivers, fast peak detectors and instrumentation amplifiers.

To reduce design times and assist in board layout, the CLC428 is supported by an evaluation board and a SPICE simulation model available from National Semiconductor.

Features

- Wide unity-gain bandwidth: 160MHz
- Ultra-low noise: $2.0nV/\sqrt{Hz}$
- Low distortion: $-78dBc$ 2nd (2MHz)
 $-62/-72dBc$ (10MHz)
- Settling time: 16ns to 0.1%
- Supply voltage range: ± 2.5 to ± 5 or single supply
- High output current: $\pm 80mA$

Applications

- General purpose dual op amp
- Low noise integrators
- Low noise active filters
- Diff-in/diff-out instrumentation amp
- Driver/receiver for transmission systems
- High-speed detectors
- I/Q channel amplifiers

Channel Matching

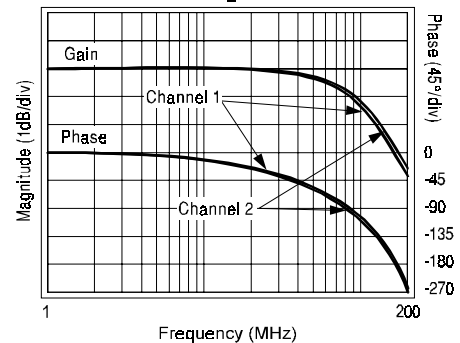

Typical Application
5-Decade Integrator

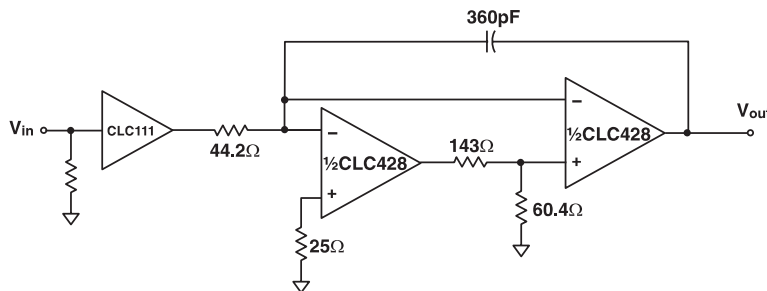

Frequency & Phase Response

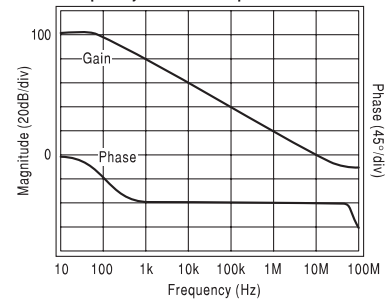

Pinout
DIP & SOIC

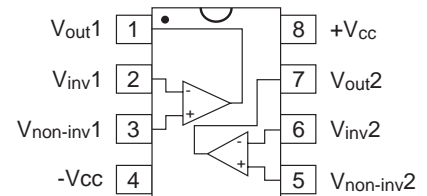

CLC428 Electrical Characteristics ($V_{CC} = \pm 5V$; $A_v = +2V/V$; $R_f = 100\Omega$; $R_g = 100\Omega$; $R_L = 100\Omega$; unless noted)

PARAMETERS	CONDITIONS	TYP	MIN/MAX RATINGS				UNITS	NOTES
			+25°C	+25°C	0 to +70°C	-40 to +85°C		
Ambient Temperature	CLC428	+25°C	+25°C	0 to +70°C	-40 to +85°C			
FREQUENCY DOMAIN RESPONSE								
gain bandwidth product	$V_{out} < 0.5V_{pp}$	135	100	80	70	MHz		
-3dB bandwidth, $A_v = +1$	$V_{out} < 0.5V_{pp}$	160	120	90	80	MHz		
	$V_{out} < 0.5V_{pp}$	80	50	40	35	MHz		
gain flatness	$V_{out} < 5.0V_{pp}$	40	25	22	20	MHz		
	$V_{out} < 0.5V_{pp}$							
peaking	DC to 200MHz	0.0	0.6	0.8	1.0	dB		
rolloff	DC to 20MHz	0.05	0.5	0.7	0.7	dB		
linear phase deviation	DC to 20MHz	0.2	1.0	1.5	1.5	°		
TIME DOMAIN RESPONSE								
rise and fall time	1V step	5.5	7.5	9.0	10.0	ns		
settling time	2V step to 0.1%	16	20	24	24	ns		
overshoot	1V step	1	5	10	10	%		
slew rate	5V step	500	300	275	250	V/ μ s		
DISTORTION AND NOISE RESPONSE								
2 nd harmonic distortion	1V _{pp} , 10MHz	-62	-50	-45	-43	dBc		
3 rd harmonic distortion	1V _{pp} , 10MHz	-72	-60	-56	-56	dBc		
equivalent input noise	1MHz to 100MHz	voltage	2.0	2.5	2.8	2.8	nV/ \sqrt Hz	
		current	2.0	3.0	3.6	4.6	pA/ \sqrt Hz	
crosstalk	input referred, 10MHz	-62	-58	-58	-58	dB		
STATIC DC PERFORMANCE								
open-loop gain		60	56	50	50	dB		
input offset voltage		1.0	2.0	3.0	3.5	mV	A	
average drift		5	---	15	20	μ V/°C		
input bias current		1.5	25	40	65	μ A	A	
average drift		150	---	600	700	nA/°C		
input offset current		0.3	3	5	5	μ A		
average drift		5	---	25	50	nA/°C		
power supply rejection ratio		66	60	55	55	dB		
common-mode rejection ratio		63	57	52	52	dB		
supply current	per channel, $R_L = \infty$	11	12	13	15	mA	A	
MISCELLANEOUS PERFORMANCE								
input resistance	common-mode	500	250	125	125	k Ω		
	differential-mode	200	50	25	25	k Ω		
input capacitance	common-mode	2.0	3.0	3.0	3.0	pF		
	differential-mode	2.0	3.0	3.0	3.0	pF		
output resistance	closed loop	0.05	0.1	0.2	0.2	Ω		
output voltage range	$R_L = \infty$	± 3.8	± 3.5	± 3.3	± 3.3	V		
	$R_L = 100\Omega$	± 3.5	± 3.2	± 2.6	± 1.3	V		
input voltage range	common mode	± 3.7	± 3.5	± 3.3	± 3.3	V		
output current		± 70	± 50	± 40	± 20	mA		

Min/max ratings are based on product characterization and simulation. Individual parameters are tested as noted. Outgoing quality levels are determined from tested parameters.

Absolute Maximum Ratings

supply voltage	$\pm 7V$
short circuit current	(note 1)
common-mode input voltage	$\pm V_{CC}$
differential input voltage	$\pm 10V$
maximum junction temperature	+150°C
storage temperature	-65°C to +150°C
lead temperature (soldering 10 sec)	+300°C

Notes

A) J-level: spec is 100% tested at +25°C, sample tested at +85°C.
1) Output is short circuit protected to ground, however maximum reliability is obtained if output current does not exceed 160mA.

Reliability Information

Transistor count 104

Ordering Information

Model	Temperature Range	Description
CLC428AJP	-40°C to +85°C	8-pin PDIP
CLC428AJE	-40°C to +85°C	8-pin SOIC
CLC428A8B	-55°C to +125°C	8-pin CerDIP, MIL-STD-883

DESC SMD number: 5962-94708

Package Thermal Resistance

Package	θ_{jc}	θ_{jA}
Plastic (AJP)	60°C/W	115°C/W
Surface Mount (AJE)	40°C/W	115°C/W
CerDIP	25°C/W	115°C/W

CLC428 Typical Performance ($T_A=+25^\circ\text{C}$, $A_V=+2$, $V_{CC}=\pm 5\text{V}$, $R_I=100\Omega$, $R_L=100\Omega$, unless noted)

Non-Inverting Frequency Response

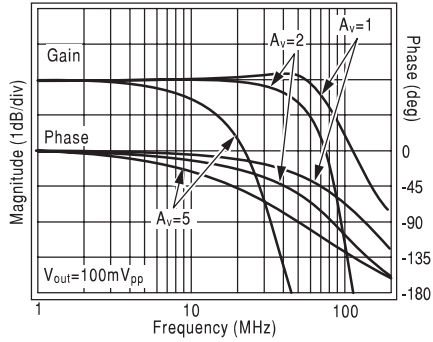

Inverting Frequency Response

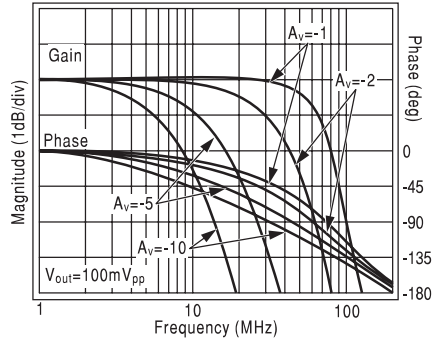

Frequency Response vs. Load Resistance

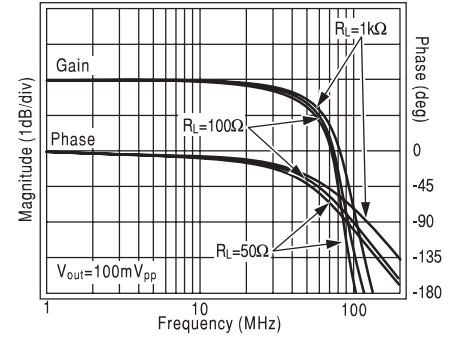

Frequency Response vs. Output Amplitude

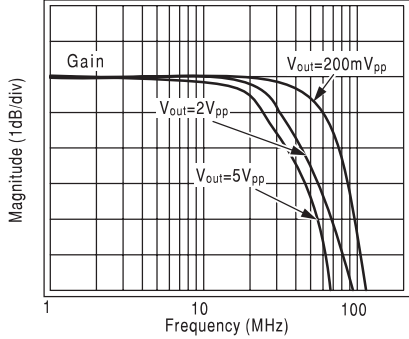

Frequency Response vs. Capacitive Load

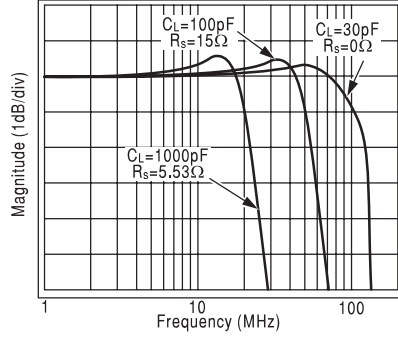

Gain Flatness & Linear Phase Deviation

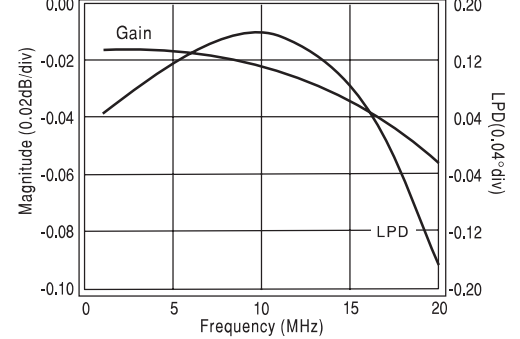

Maximum Output Voltage vs. Load

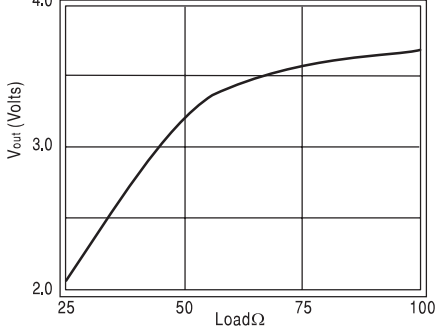

Channel-to-Channel Crosstalk

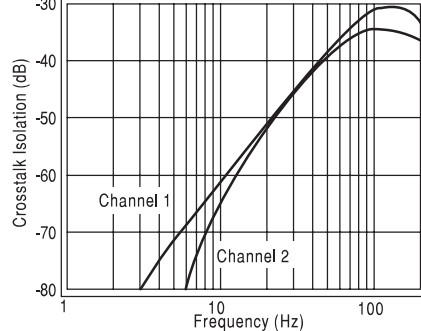

Open-Loop Gain & Phase

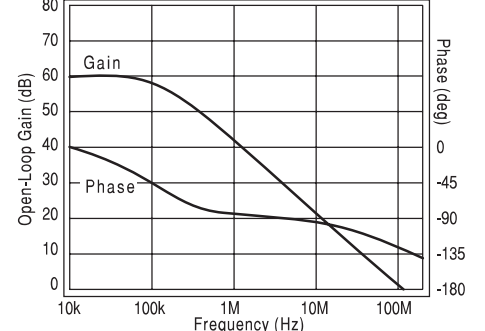

2nd and 3rd Harmonic Distortion

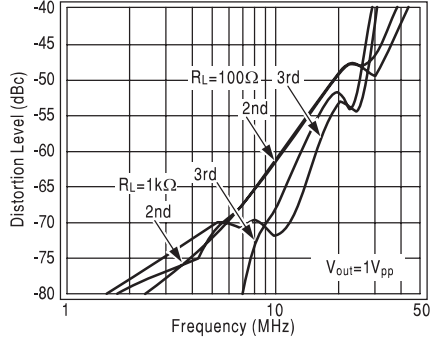

2nd Harmonic Distortion vs. Output Voltage

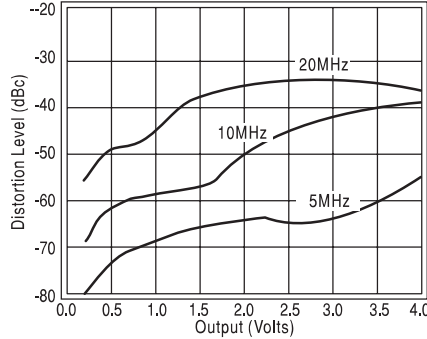

3rd Harmonic Distortion vs. Output Voltage

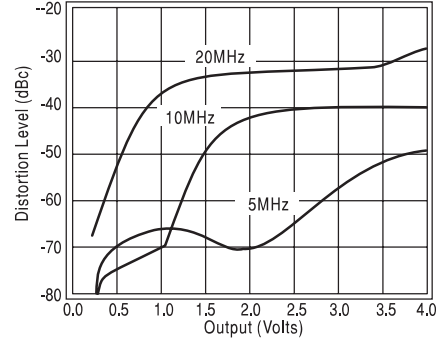

Closed-Loop Output Resistance

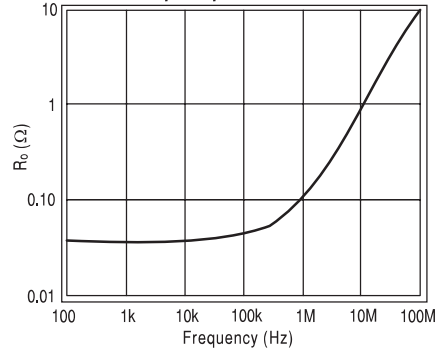

Equivalent Input Noise

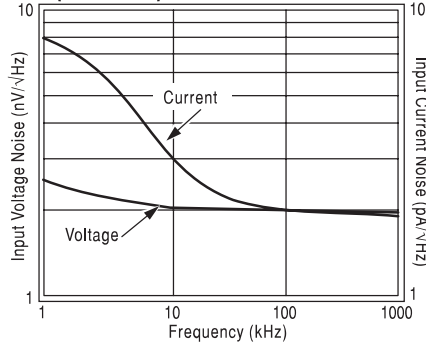

2-Tone, 3rd Order Intermodulation Intercept

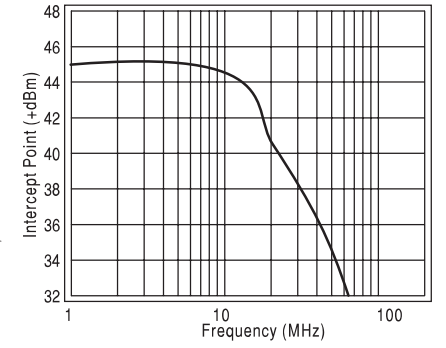

CLC428 Typical Performance ($T_A=+25^\circ\text{C}$, $A_V=+2$, $V_{CC}=\pm 5\text{V}$, $R_f=100\Omega$, $R_L=100\Omega$, unless noted)

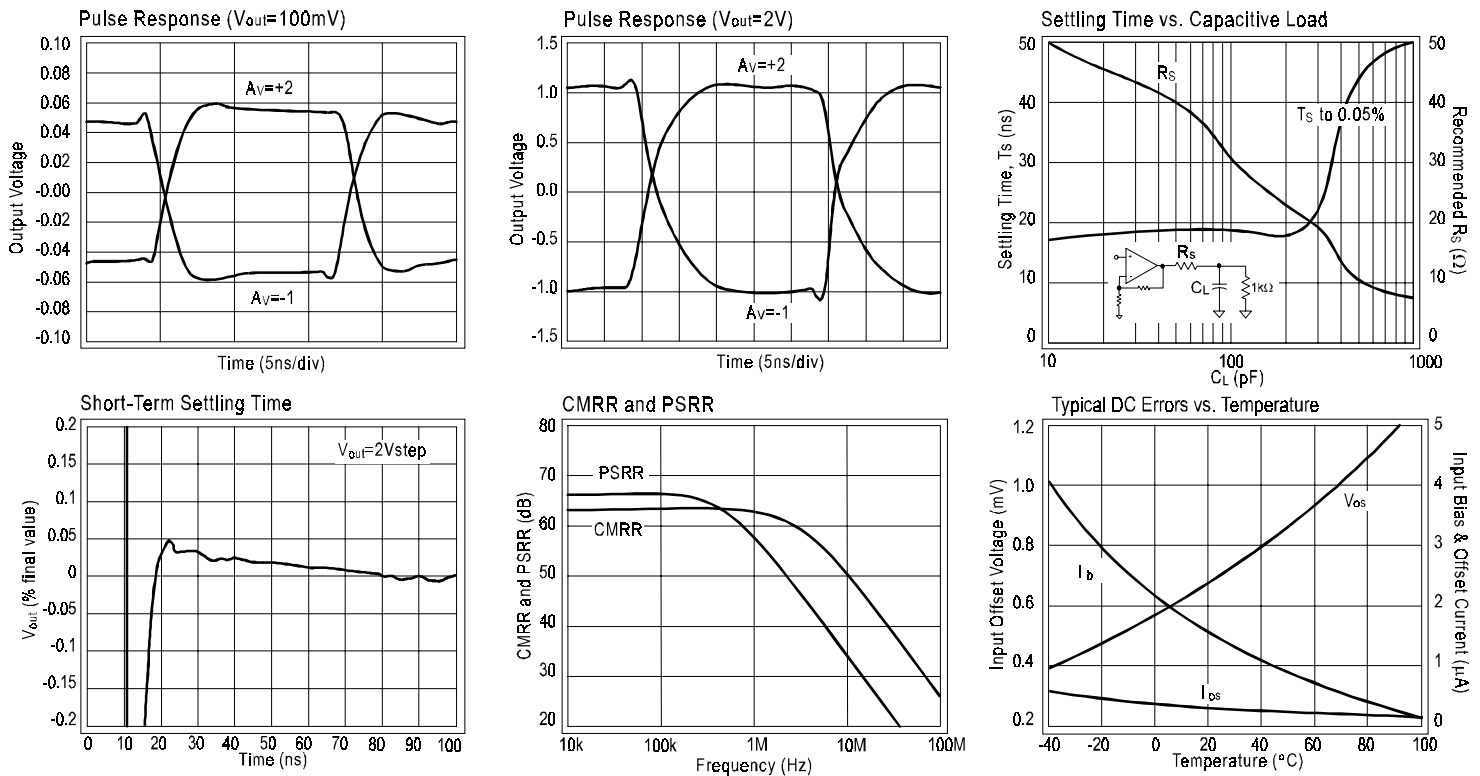

Application Discussion

Low Noise Design

Ultimate low noise performance from circuit designs using the CLC428 requires the proper selection of external resistors. By selecting appropriate low-valued resistors for R_f and R_G , amplifier circuits using the CLC428 can achieve output noise that is approximately the equivalent voltage input noise of $2.0 \text{ nV}/\sqrt{\text{Hz}}$ multiplied by the desired gain (A_V).

Each amplifier in the CLC428 has an equivalent input noise resistance which is optimum for matching source impedances of approximately 1k . Using a transformer, any source can be matched to achieve the lowest noise design.

For even lower noise performance than the CLC428, consider the CLC425 or CLC426 at 1.05 and $1.6 \text{ nV}/\sqrt{\text{Hz}}$, respectively.

DC Bias Currents and Offset Voltages

Cancellation of the output offset voltage due to input bias currents is possible with the CLC428. This is done by making the resistance seen from the inverting and non-inverting inputs equal. Once done, the residual output offset voltage will be the input offset voltage (V_{OS}) multiplied by the desired gain (A_V). Comlinear Application Note OA-7 offers several solutions to further reduce the output offset.

Output and Supply Considerations

With $\pm 5\text{V}$ supplies, the CLC428 is capable of a typical output swing of $\pm 3.8\text{V}$ under a no-load condition. Additional output swing is possible with slightly higher supply voltages. For loads of less than 50Ω , the output swing will be limited by the CLC428's output current capability, typically 80mA .

Output settling time when driving capacitive loads can be improved by the use of a series output resistor. See the plot labeled "Settling Time vs. Capacitive Load" in the Typical Performance section.

Layout

Proper power supply bypassing is critical to insure good high frequency performance and low noise. De-coupling capacitors of $0.1\mu\text{F}$ should be placed as close as possible to the power supply pins. The use of surface mounted capacitors is recommended due to their low series inductance.

A good high frequency layout will keep power supply and ground traces away from the inverting input and output pins. Parasitic capacitance from these nodes to ground causes frequency response peaking and possible circuit oscillation. See OA-15 for more information. National suggests the CLC730038 (through-hole) or the CLC730036 (SOIC) dual op amp evaluation board as a guide for high frequency layout and as an aid in device evaluation.

Analog Delay Circuit (All-Pass Network)

The circuit in Figure 1 implements an all-pass network using the CLC428. A wide bandwidth buffer (CLC111) drives the circuit and provides a high input impedance for the source. As shown in Figure 2, the circuit provides a

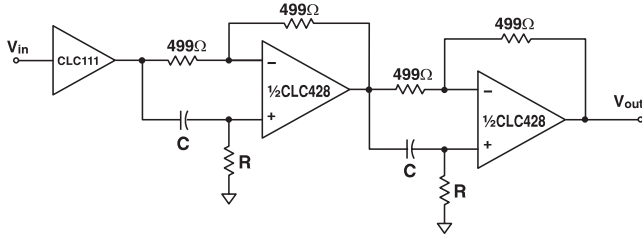

Figure 1

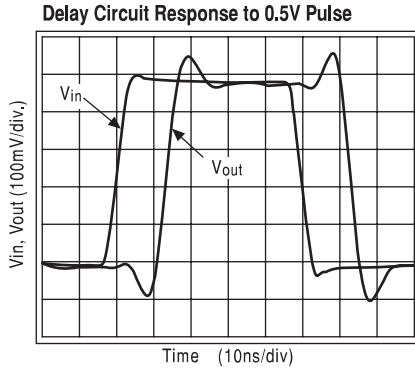

Figure 2

13.1ns delay (with $R = 40.2\Omega$, $C = 47\text{pF}$). R_f and R_g should be of equal and low value for parasitic insensitive operation. The circuit gain is +1 and the delay is determined by the following equations.

$$\tau_{\text{delay}} = 2(2RC + T_d) \quad \text{Eq. 1}$$

$$T_d = \frac{1}{360} \frac{d\phi}{df}; \quad \text{Eq. 2}$$

where T_d is the delay of the op amp at $A_V = +1$. The CLC428 provides a typical delay of 2.8ns at its -3dB point.

Full Duplex Digital or Analog Transmission

Simultaneous transmission and reception of analog or digital signals over a single coaxial cable or twisted-pair line can reduce cabling requirements. The CLC428's wide bandwidth and high common-mode rejection in a differential amplifier configuration allows full duplex transmission of video, telephone, control and audio signals.

In the circuit shown in Figure 3, one of the CLC428's amps is used as a "driver" and the other as a difference "receiver" amplifier. The output impedance of the "driver" is essentially zero. The two R's are chosen to match the characteristic impedance of the transmission line. The "driver" op amp gain can be selected for unity or greater.

Receiver amplifier A_2 (B_2) is connected across R and forms differential amplifier for the signals transmitted by driver A_1 (B_1). If the coax cable is lossless and R_f equals R_g , receiver A_2 (B_2) will then reject the signals from driver

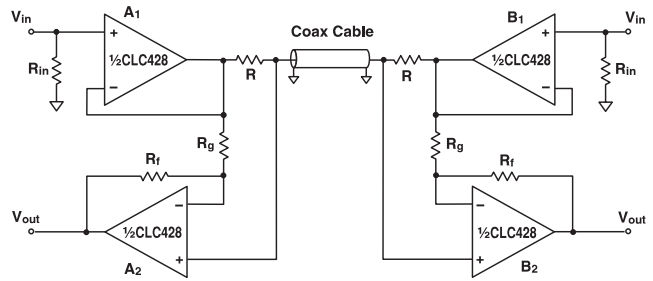

Figure 3

A_1 (B_1) and pass the signals from driver B_1 (A_1). The output of the receiver amplifier will be:

$$V_{\text{out}_{A(B)}} = \frac{1}{2} V_{\text{in}_{A(B)}} \left(1 - \frac{R_f}{R_g} \right) + \frac{1}{2} V_{\text{in}_{B(A)}} \left(1 + \frac{R_f}{R_g} \right) \quad \text{Eq. 3}$$

Care must be given to layout and component placement to maintain a high frequency common-mode rejection. The plot of Figure 4 shows the simultaneous reception of signals transmitted at 1MHz and 10MHz.

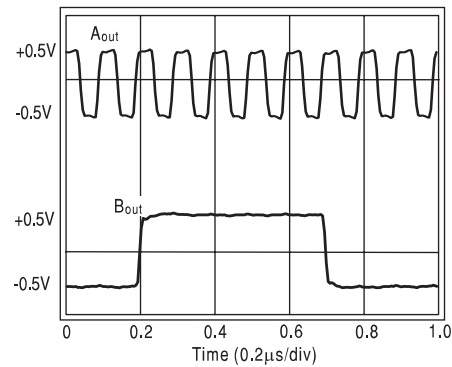

Figure 4

Five Decade Integrator

A composite integrator, as shown in Figure 5, uses the CLC428 dual op amp to increase the circuits' usable frequency range of operation. The transfer function of this circuit is:

$$V_o = \frac{1}{RC} \int V_{\text{in}} dt \quad \text{Eq. 4}$$

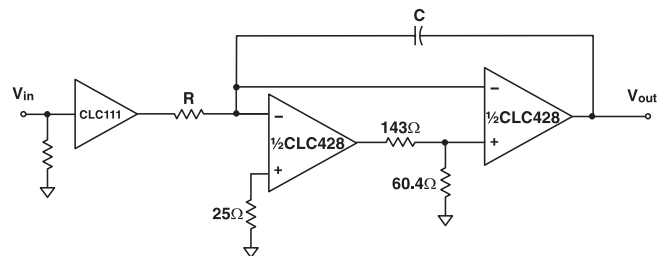

Figure 5

A resistive divider made from the 143Ω and 60.4Ω resistors was chosen to reduce the loop-gain and stabilize the network. The CLC428 composite integrator provides integration over five decades of operation. R and C set the integrator's gain. Figure 6 shows the frequency and phase response of the circuit in Figure 5 with $R = 44.2\Omega$ and $C = 360\text{pF}$.

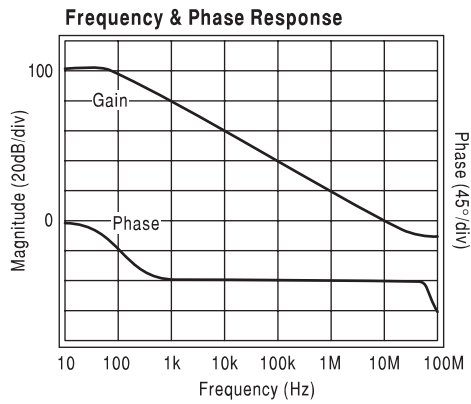

Figure 6

Positive Peak Detector

The CLC428's dual amplifiers can be used to implement a unity-gain peak detector circuit as shown in Figure 7.

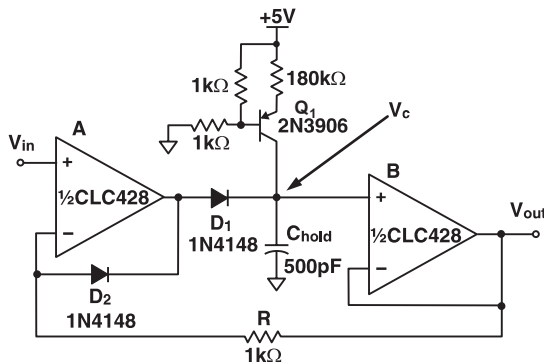

Figure 7

The acquisition speed of this circuit is limited by the dynamic resistance of the diode when charging C_{hold} . A plot of the of the circuit's performance is shown in Figure 8 with a 1MHz sinusoidal input.

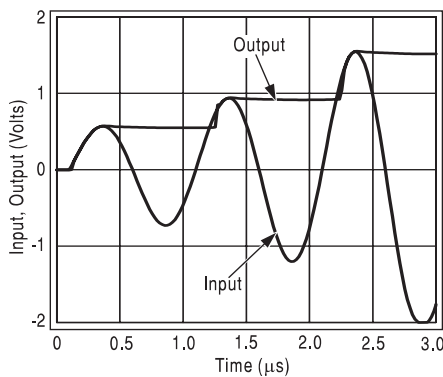

Figure 8

A current source, built around Q_1 , provides the necessary bias current for the second amplifier and prevents saturation when power is applied. The resistor, R , closes the loop while diode D_2 prevents negative saturation when V_{in} is less than V_c . A MOS-type switch (not shown) can be used to reset the capacitor's voltage.

The maximum speed of detection is limited by the delay of the op amps and the diodes. The use of Schottky diodes will provide faster response.

Adjustable or Bandpass Equalizer

A "boost" equalizer can be made with the CLC428 by summing a bandpass response with the input signal, as shown in Figure 9.

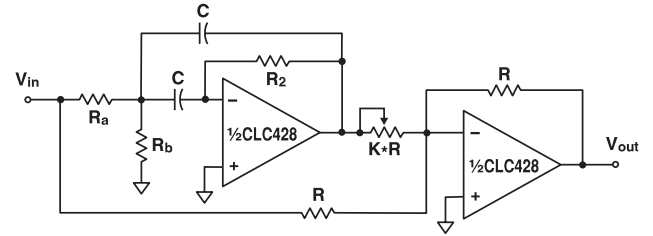

Figure 9

The overall transfer function is shown in Eq. 5.

$$\frac{V_{out}}{V_{in}} = \left(\frac{R_b}{K(R_a + R_b)} \right) \frac{s2Q\omega_o}{s^2 + s\frac{\omega_o}{Q} + \omega_o^2} - 1 \quad \text{Eq. 5}$$

To build a boost circuit, use the design equations Eq. 6 and Eq. 7.

$$\frac{R_2 C}{2} = \frac{Q}{\omega_o}, \quad 2C(R_a || R_b) = \frac{1}{Q\omega_o} \quad \text{Eq. 6,7}$$

Select R_2 and C using Eq. 6. Use reasonable values for high frequency circuits - R_2 between 10Ω and $5k\Omega$, C between $10pF$ and $2000pF$. Use Eq. 7 to determine the parallel combination of R_a and R_b . Select R_a and R_b by either the 10Ω to $5k\Omega$ criteria or by other requirements based on the impedance V_{in} is capable of driving. Finish the design by determining the value of K from Eq. 8.

$$\text{Peak Gain} = \frac{V_{out}}{V_{in}}(\omega_o) = \frac{R_2}{2KR_a} - 1 \quad \text{Eq. 8}$$

Figure 10 shows an example of the response of the circuit of Figure 9, where f_o is 2.3MHz. The component values are as follows: $R_a = 2.1k\Omega$, $R_b = 68.5\Omega$, $R_2 = 4.22k\Omega$, $R = 500\Omega$, $KR = 50\Omega$, $C = 120pF$.

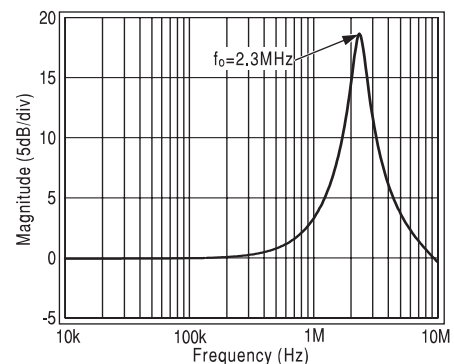

Figure 10

This page intentionally left blank.

Customer Design Applications Support

National Semiconductor is committed to design excellence. For sales, literature and technical support, call the National Semiconductor Customer Response Group at **1-800-272-9959** or fax **1-800-737-7018**.

Life Support Policy

National's products are not authorized for use as critical components in life support devices or systems without the express written approval of the president of National Semiconductor Corporation. As used herein:

1. Life support devices or systems are devices or systems which, a) are intended for surgical implant into the body, or b) support or sustain life, and whose failure to perform, when properly used in accordance with instructions for use provided in the labeling, can be reasonably expected to result in a significant injury to the user.
2. A critical component is any component of a life support device or system whose failure to perform can be reasonably expected to cause the failure of the life support device or system, or to affect its safety or effectiveness.



National Semiconductor Corporation

1111 West Bardin Road
Arlington, TX 76017
Tel: 1(800) 272-9959
Fax: 1(800) 737-7018

National Semiconductor Europe

Fax: (+49) 0-180-530 85 86
E-mail: europe.support.nsc.com
Deutsch Tel: (+49) 0-180-530 85 85
English Tel: (+49) 0-180-532 78 32
Francais Tel: (+49) 0-180-532 93 58
Italiano Tel: (+49) 0-180-534 16 80

National Semiconductor Hong Kong Ltd.

2501 Miramar Tower
1-23 Kimberley Road
Tsimshatsui, Kowloon
Hong Kong
Tel: (852) 2737-1600
Fax: (852) 2736-9960

National Semiconductor Japan Ltd.

Tel: 81-043-299-2309
Fax: 81-043-299-2408

National does not assume any responsibility for use of any circuitry described, no circuit patent licenses are implied and National reserves the right at any time without notice to change said circuitry and specifications.