

CLC5654

Very High-Speed, Low-Cost, Quad Operational Amplifier

General Description

The CLC5654 is a quad, current feedback operational amplifier that is perfect for many cost-sensitive applications that require high performance. This device also offers excellent economy in board space and power, consuming only 5mA per amplifier while providing 70mA of output current capability. Applications requiring significant density of high speed devices such as video routers, matrix switches and high-order active filters will benefit from the configuration of the CLC5654 and the low channel-to-channel crosstalk of 70dB at 5MHz.

The CLC5654 provides excellent performance for video applications. Differential gain and phase of 0.03% and 0.03° makes this device well suited for many professional composite video systems, but consumer applications will also be able to take advantage of these features due to the device's low cost. The CLC5654 offers superior dynamic performance with a small signal bandwidth of 450MHz and slew rate of 2000V/μs. These attributes are well suited for many component video applications such as driving RGB signals down significant lengths of cable. These and many other application can also take advantage of the 0.1dB flatness to 40MHz.

Combining wide bandwidth with low cost makes the the CLC5654 an attractive option for active filters. SAW filters are often used in IF filters in the 10's of MHz range, but higher order filters designed around a quad operational amplifier may offer an economical alternative to the typical SAW approach and offer greater freedom in the selection of filter parameters. National Semiconductor's Comlinear Products Group has published a wide array of literature on active filters and a list of these publications can be found on the last page of this datasheet.

Features

- 450MHz small signal bandwidth
- 2000 V/μs slew rate
- 5mA / channel supply current
- -71/-82dBc HD2/HD3 (5MHz)
- 0.03%, 0.03° differential gain, phase
- 70mA output current
- 12ns settling to 0.1%

Applications

- High performance RGB video
- Video switchers & routers
- Video line driver
- Active filters
- IF amplifier
- Twisted pair driver/receiver

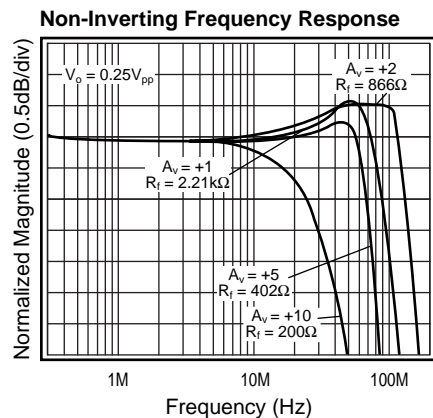

Typical Configurations

Non-Inverting Gain

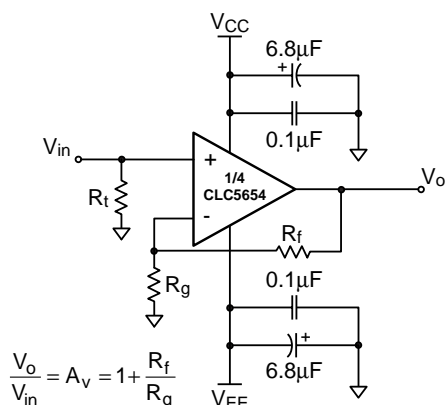

Inverting Gain

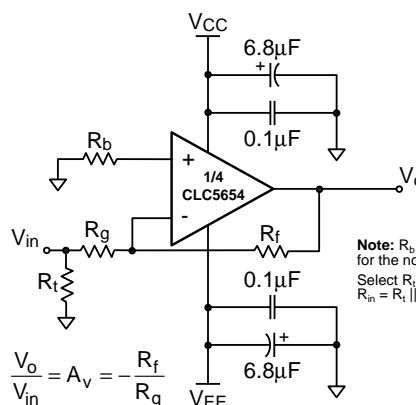

Note: R_b provides DC bias for the non-inverting input. Select R_i to yield desired $R_{in} = R_i \parallel R_g$.

Pinout DIP & SOIC

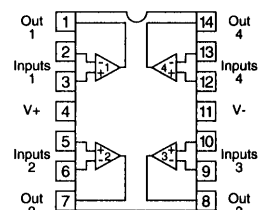

CLC5654 Electrical Characteristics ($A_v = +2$, $R_f = 866\Omega$, $R_L = 100\Omega$, $V_s = \pm 5V$, unless specified)

PARAMETERS	CONDITIONS	TYP	MIN/MAX RATINGS		UNITS	NOTES
Ambient Temperature	CLC5654I	+25°C	+25°C	-40 to 85°C		
FREQUENCY DOMAIN RESPONSE						
-3dB bandwidth	$A_v = 1$	450	–	–	MHz	
	$V_o < 0.5V_{pp}$	350	–	–	MHz	
	$V_o < 5V_{pp}$	100	–	–	MHz	
0.1dB bandwidth		40	–	–	MHz	
differential gain	NTSC, $R_L = 150\Omega$	0.03	–	–	dB	
differential phase	NTSC, $R_L = 150\Omega$	0.03	–	–	dB	
TIME DOMAIN RESPONSE						
rise and fall time	0.5V step	1.2	–	–	ns	
	5V step	2.7	–	–	ns	
settling time to 0.1%	2V step	12	–	–	ns	
overshoot	0.5V step	7	–	–	%	
slew rate		2000	–	–	V/ μ s	
DISTORTION AND NOISE RESPONSE						
2 nd harmonic distortion	$2V_{pp}$, 5MHz	-71	–	–	dBc	
3 rd harmonic distortion	$2V_{pp}$, 5MHz	-82	–	–	dBc	
equivalent input noise voltage (e_{ni})	>1MHz	3.3	–	–	nV/ \sqrt{Hz}	
non-inverting current (i_{bn})	>1MHz	2.5	–	–	pA/ \sqrt{Hz}	
inverting current (i_{bi})	>1MHz	12	–	–	pA/ \sqrt{Hz}	
crosstalk (input inferred)	10MHz	76	–	–	dBc	
STATIC DC PERFORMANCE						
input offset voltage		2.5	6	11	mV	A
average drift		18	–	55	μ V/ $^{\circ}$ C	
input bias current (non-inverting)		6	15	28	μ A	A
average drift		40	–	160	nA/ $^{\circ}$ C	
input bias current (inverting)		5	12	20	μ A	A
average drift		25	–	120	nA/ $^{\circ}$ C	
power supply rejection ratio	DC	55	47	45	dB	
common-mode rejection ratio	DC	50	45	43	dB	
supply current (per channel)	$R_L = \infty$	5	6.7	7	mA	A
MISCELLANEOUS PERFORMANCE						
input resistance (non-inverting)		1	0.5	0.25	M Ω	
input capacitance (non-inverting)		1	2	2	pF	
common-mode input range		± 2.2	± 2.0	± 1.4	V	
output voltage range	$R_L = 150\Omega$	± 2.6	± 2.5	± 2.3	V	
output current		70	50	40	mA	
output resistance, closed loop	DC	0.2	0.3	0.6	m Ω	

Min/max ratings are based on product characterization and simulation. Individual parameters are tested as noted. Outgoing quality levels are determined from tested parameters.

Notes

A) J-level: spec is 100% tested at +25°C.

Reliability Information

Transistor Count	152
MTBF (based on limited test data)	12.5Mhr

Package Thermal Resistance

Package	θ_{JC}	θ_{JA}
Plastic (IN)	60°C/W	110°C/W
Surface Mount (IM)	55°C/W	125°C/W

Absolute Maximum Ratings

supply voltage ($V_{CC} - V_{EE}$)	+14V
output current	95mA
common-mode input voltage	V_{EE} to V_{CC}
maximum junction temperature	+150°C
storage temperature range	-65°C to +150°C
lead temperature (soldering 10 sec)	+300°C

Ordering Information

Model	Temperature Range	Description
CLC5654IN	-40°C to +85°C	14-pin PDIP
CLC5654IM	-40°C to +85°C	14-pin SOIC
CLC5654IMX	-40°C to +85°C	14-pin tape and reel

CLC5654 Typical Performance ($A_v = +2$, $R_f = 866\Omega$, $R_L = 100\Omega$, $V_s = \pm 5V$, unless specified)

Non-Inverting Frequency Response

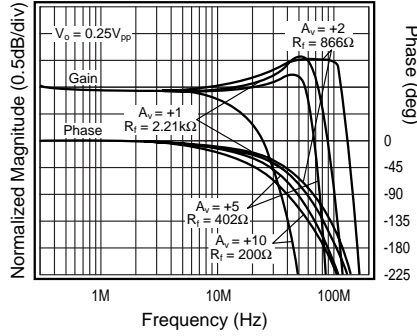

Inverting Frequency Response

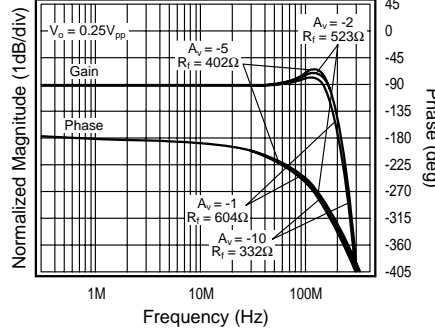

Frequency Response vs. R_L

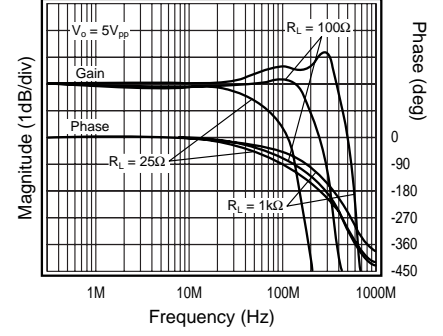

Frequency Response vs. V_o

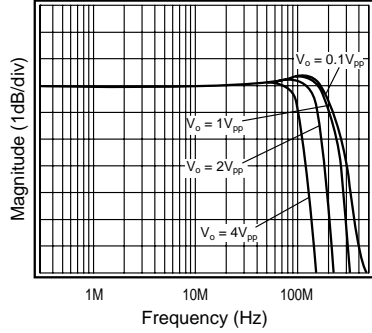

2nd & 3rd Harmonic Distortion

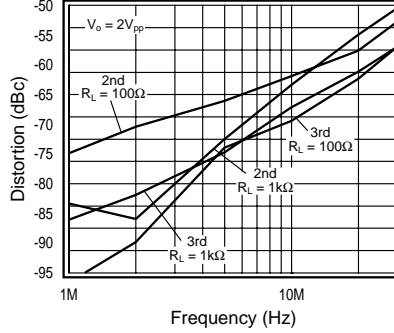

2nd & 3rd Harmonic Distortion, $R_L = 1k\Omega$

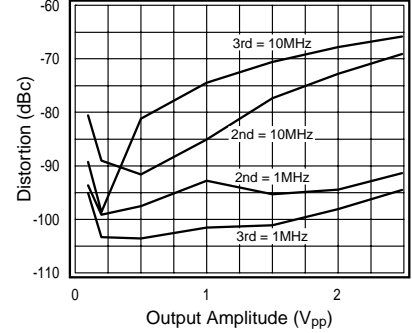

2nd & 3rd Harmonic Distortion, $R_L = 100\Omega$

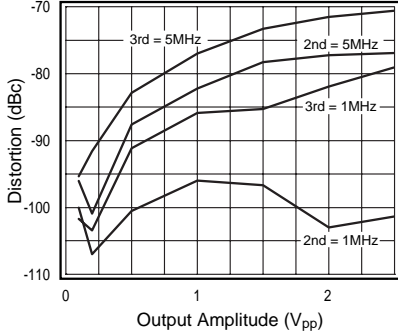

2nd & 3rd Harmonic Distortion, $R_L = 25\Omega$

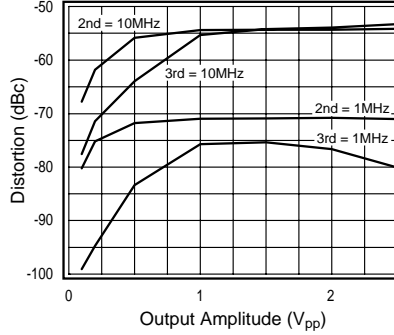

Large & Small Signal Pulse Response

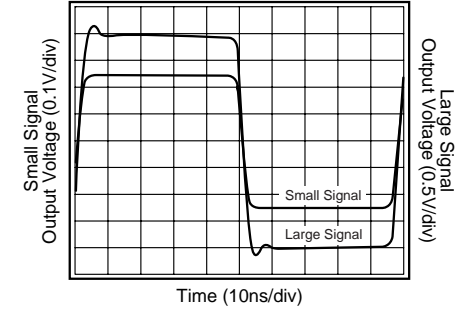

All Hostile Crosstalk

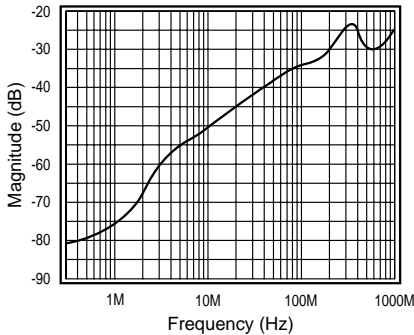

Most Susceptible Channel Pulse Coupling

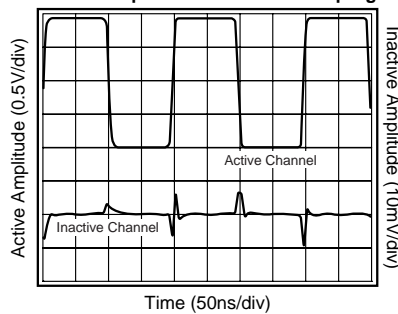

Channel to Channel Gain Matching

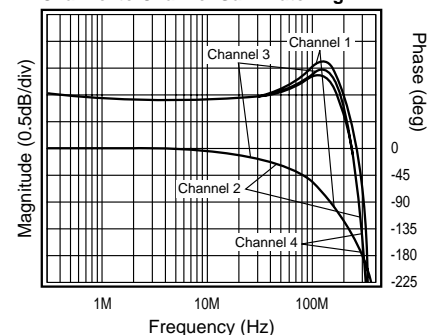

Equivalent Input Noise

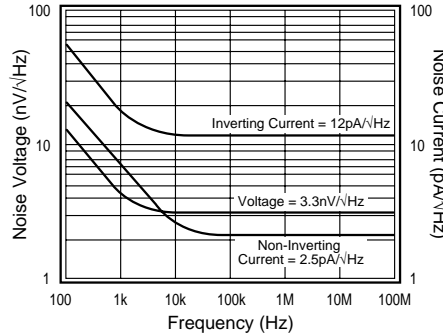

Open-Loop Transimpedance Gain, Z(s)

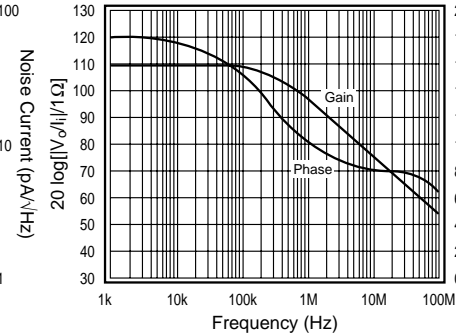

Gain Flatness & Linear Phase

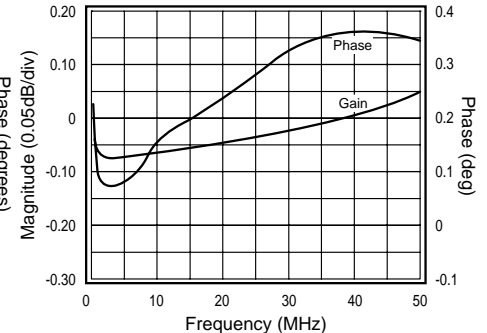

Current Feedback Amplifiers

Some of the key features of current feedback technology are:

- Independence of AC bandwidth and voltage gain
- Inherently stable at unity gain
- Adjustable frequency response with R_f
- High slew rate
- Fast settling

Current feedback operation can be described using a simple equation. The voltage gain for a non-inverting or inverting current feedback amplifier is approximated by Equation 1.

$$\frac{V_o}{V_i} = \frac{A_v}{1 + \frac{R_f}{Z(j\omega)}} \quad \text{Equation 1}$$

where:

- A_v is the closed loop DC voltage gain
- R_f is the feedback resistor
- $Z(j\omega)$ is the open loop transimpedance gain

The denominator of Equation 1 is approximately equal to 1 at low frequencies. Near the -3dB corner frequency, the interaction between R_f and $Z(j\omega)$ dominates the circuit performance. The value of the feedback resistor has a large affect on the circuits performance. Increasing R_f has the following affects:

- Decreases loop gain
- Decreases bandwidth
- Reduces gain peaking
- Lowers pulse response overshoot
- Affects frequency response phase linearity

Layout Considerations

A proper printed circuit layout is essential for achieving high frequency performance. National provides evaluation boards for the CLC5654 (CLC730024 - DIP, CLC730031 - SOIC) and suggests their use as a guide for high frequency layout and as an aid for device testing and characterization. General layout and supply bypassing play major roles in high frequency performance. Follow the steps below as a basis for high frequency layout:

- Include 6.8 μ F tantalum and 0.1 μ F ceramic capacitors on both supplies.
- Place the 6.8 μ F capacitors within 0.75 inches of the power pins.
- Place the 0.1 μ F capacitors less than 0.1 inches from the power pins.
- Remove the ground plane under and around the part, especially near the input and output pins to reduce parasitic capacitance.
- Minimize all trace lengths to reduce series inductances.
- Use flush-mount printed circuit board pins for prototyping, never use high profile DIP sockets.

Active Filter Application Notes

- OA-21 Simplified Component Pre-Distortion for High Speed Active Filters
- OA-26 Designing High-Speed Active Filters
- OA-27 Low-Sensitivity, Lowpass Filter Design
- OA-28 Low-Sensitivity, Bandpass Filter Design with Tuning Method
- OA-29 Low-Sensitivity, Highpass Filter Design with Parasitic Compensation

Customer Design Applications Support

National Semiconductor is committed to design excellence. For sales, literature and technical support, call the National Semiconductor Customer Response Group at **1-800-272-9959** or fax **1-800-737-7018**.

Life Support Policy

National's products are not authorized for use as critical components in life support devices or systems without the express written approval of the president of National Semiconductor Corporation. As used herein:

1. Life support devices or systems are devices or systems which, a) are intended for surgical implant into the body, or b) support or sustain life, and whose failure to perform, when properly used in accordance with instructions for use provided in the labeling, can be reasonably expected to result in a significant injury to the user.
2. A critical component is any component of a life support device or system whose failure to perform can be reasonably expected to cause the failure of the life support device or system, or to affect its safety or effectiveness.



National Semiconductor Corporation
 1111 West Bardin Road
 Arlington, TX 76017
 Tel: 1(800) 272-9959
 Fax: 1(800) 737-7018

National Semiconductor Europe
 Fax: (+49) 0-180-530 85 86
 E-mail: europe.support.nsc.com
 Deutsch Tel: (+49) 0-180-530 85 85
 English Tel: (+49) 0-180-532 78 32
 Francais Tel: (+49) 0-180-532 93 58
 Italiano Tel: (+49) 0-180-534 16 80

National Semiconductor Hong Kong Ltd.
 2501 Miramar Tower
 1-23 Kimberley Road
 Tsimshatsui, Kowloon
 Hong Kong
 Tel: (852) 2737-1600
 Fax: (852) 2736-9960

National Semiconductor Japan Ltd.
 Tel: 81-043-299-2309
 Fax: 81-043-299-2408

National does not assume any responsibility for use of any circuitry described, no circuit patent licenses are implied and National reserves the right at any time without notice to change said circuitry and specifications.