

DS26LS31C/DS26LS31M Quad High Speed Differential Line Driver

General Description

The DS26LS31 is a quad differential line driver designed for digital data transmission over balanced lines. The DS26LS31 meets all the requirements of EIA Standard RS-422 and Federal Standard 1020. It is designed to provide unipolar differential drive to twisted-pair or parallel-wire transmission lines.

The circuit provides an enable and disable function common to all four drivers. The DS26LS31 features TRI-STATE® outputs and logically ANDed complementary outputs. The inputs are all LS compatible and are all one unit load.

Features

- Output skew—2.0 ns typical
- Input to output delay—10 ns typical
- Operation from single 5V supply
- Outputs won't load line when $V_{CC} = 0V$
- Four line drivers in one package for maximum package density
- Output short-circuit protection
- Complementary outputs
- Meets the requirements of EIA Standard RS-422
- Pin compatible with AM26LS31
- Available in military and commercial temperature range

Logic and Connection Diagrams

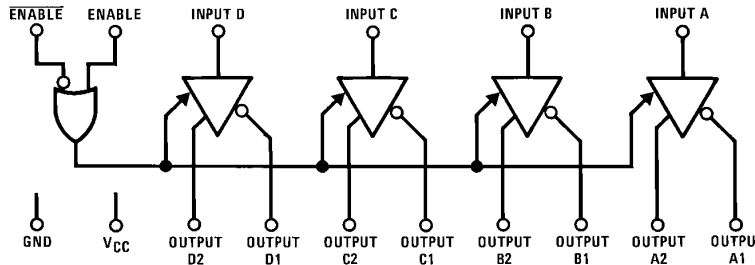

TL/F/5778-1

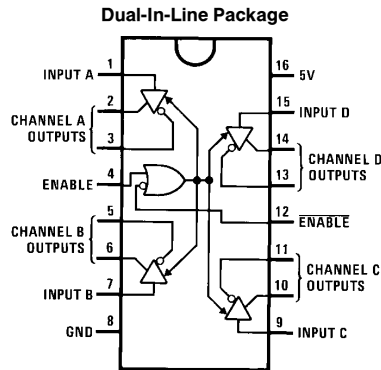

TL/F/5778-2

Top View
Order Number DS26LS31CJ, DS26LS31CM,
DS26LS31CN or DS26LS31MJ
See NS Package Number J16A, M16A or N16A

For Complete Military 883 Specifications, see RETS Data Sheet.
Order Number DS26LS31MJ/883 or DS26LS31MW/883
See NS Package J16A or W16A

TRI-STATE® is a registered trademark of National Semiconductor Corporation.

Absolute Maximum Ratings (Note 1)

If Military/Aerospace specified devices are required, please contact the National Semiconductor Sales Office/Distributors for availability and specifications.

Supply Voltage	7V
Input Voltage	7V
Output Voltage	5.5V
Output Voltage (Power OFF)	-0.25 to 6V

Maximum Power Dissipation* at 25°C

Cavity Package	1509 mW
Molded DIP Package	1476 mW
SO Package	1051 mW

*Derate cavity package 10.1 mW/°C above 25°C; derate molded DIP package 11.9 mW/°C above 25°C; derate SO package 8.41 mW/°C above 25°C.

Operating Conditions

	Min	Max	Units
Supply Voltage, V_{CC}			
DS26LS31M	4.5	5.5	V
DS26LS31	4.75	5.25	V
Temperature, T_A			
DS26LS31M	-55	+125	°C
DS26LS31	0	+70	°C

Electrical Characteristics (Notes 2, 3 and 4)

Symbol	Parameter	Conditions	Min	Typ	Max	Units
V_{OH}	Output High Voltage	$I_{OH} = -20$ mA	2.5			V
V_{OL}	Output Low Voltage	$I_{OL} = 20$ mA			0.5	V
V_{IH}	Input High Voltage		2.0			V
V_{IL}	Input Low Voltage				0.8	V
I_{IL}	Input Low Current	$V_{IN} = 0.4$ V		-40	-200	μA
I_{IH}	Input High Current	$V_{IN} = 2.7$ V			20	μA
I_I	Input Reverse Current	$V_{IN} = 7$ V			0.1	mA
I_O	TRI-STATE Output Current	$V_O = 2.5$ V			20	μA
		$V_O = 0.5$ V			-20	μA
V_{CL}	Input Clamp Voltage	$I_{IN} = -18$ mA			-1.5	V
I_{SC}	Output Short-Circuit Current		-30		-150	mA
I_{CC}	Power Supply Current	All Outputs Disabled or Active		35	60	mA

Switching Characteristics $V_{CC} = 5$ V, $T_A = 25$ °C

Symbol	Parameter	Conditions	Min	Typ	Max	Units
t_{PLH}	Input to Output	$C_L = 30$ pF		10	15	ns
t_{PHL}	Input to Output	$C_L = 30$ pF		10	15	ns
Skew	Output to Output	$C_L = 30$ pF		2.0	6.0	ns
t_{LZ}	Enable to Output	$C_L = 10$ pF, S2 Open		15	35	ns
t_{HZ}	Enable to Output	$C_L = 10$ pF, S1 Open		15	25	ns
t_{ZL}	Enable to Output	$C_L = 30$ pF, S2 Open		20	30	ns
t_{ZH}	Enable to Output	$C_L = 30$ pF, S1 Open		20	30	ns

Note 1: "Absolute Maximum Ratings" are those values beyond which the safety of the device cannot be guaranteed. They are not meant to imply that the devices should be operated at these limits. The tables of "Electrical Characteristics" provide conditions for actual device operation.

Note 2: Unless otherwise specified min/max limits apply across the -55°C to +125°C temperature range for the DS726LS31M and across the 0°C to +70°C range for the DS26LS31. All typicals are given for $V_{CC} = 5$ V and $T_A = 25$ °C.

Note 3: All currents into device pins are positive; all currents out of device pins are negative. All voltages are referenced to ground unless otherwise specified.

Note 4: Only one output at a time should be shorted.

AC Test Circuit and Switching Time Waveforms

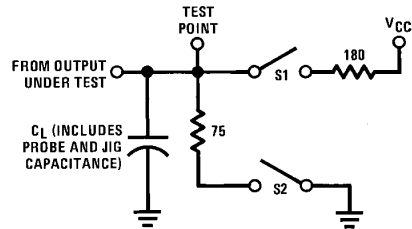

Note: S1 and S2 of load circuit are closed except where shown. TL/F/5778-3

FIGURE 1. AC Test Circuit

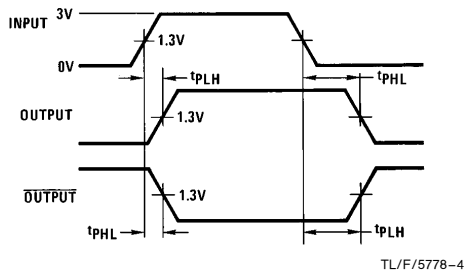

$f = 1 \text{ MHz}$, $t_r \leq 15 \text{ ns}$, $t_f \leq 6 \text{ ns}$

FIGURE 2. Propagation Delays

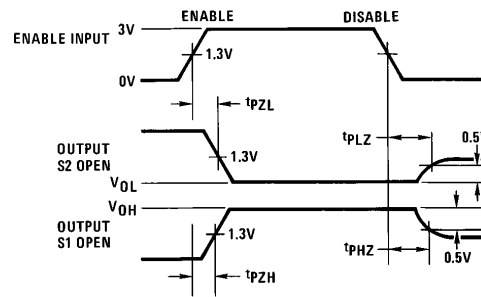

$f = 1 \text{ MHz}$, $t_r \leq 15 \text{ ns}$, $t_f \leq 6 \text{ ns}$

FIGURE 3. Enable and Disable Times

Typical Applications

Two-Wire Balanced System, RS-422

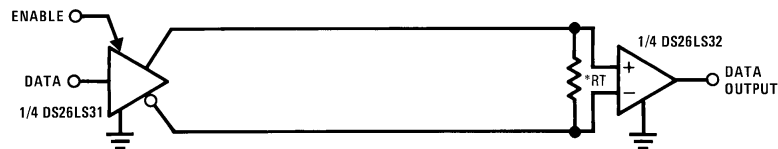

*RT is optional although highly recommended to reduce reflection.

TL/F/5778-6

Typical Performance Characteristics

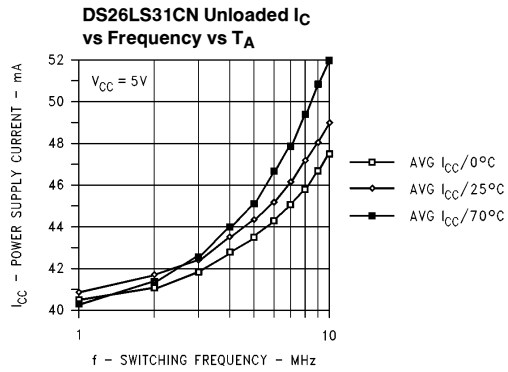

TL/F/5778-7

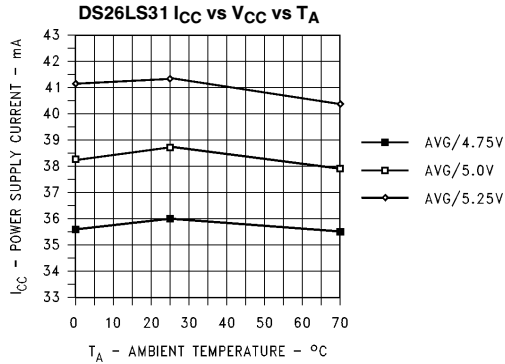

TL/F/5778-8

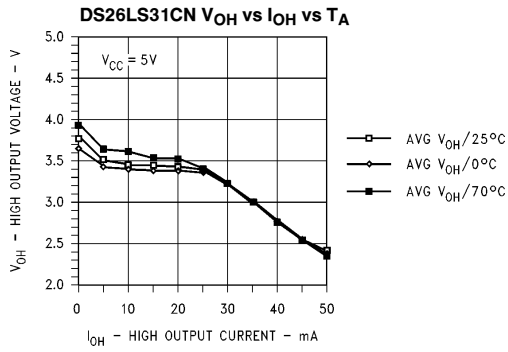

TL/F/5778-9

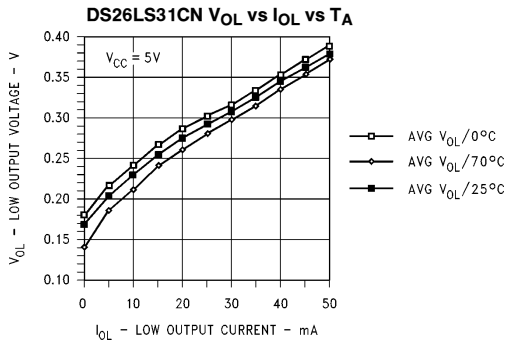

TL/F/5778-10

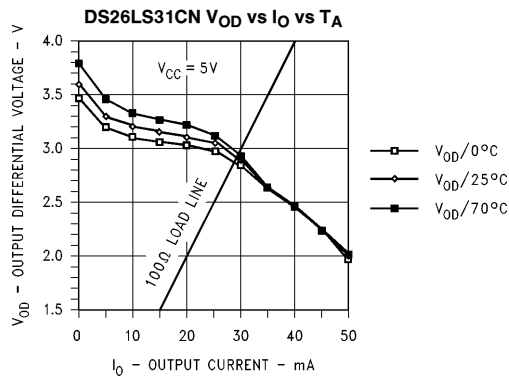

TL/F/5778-11

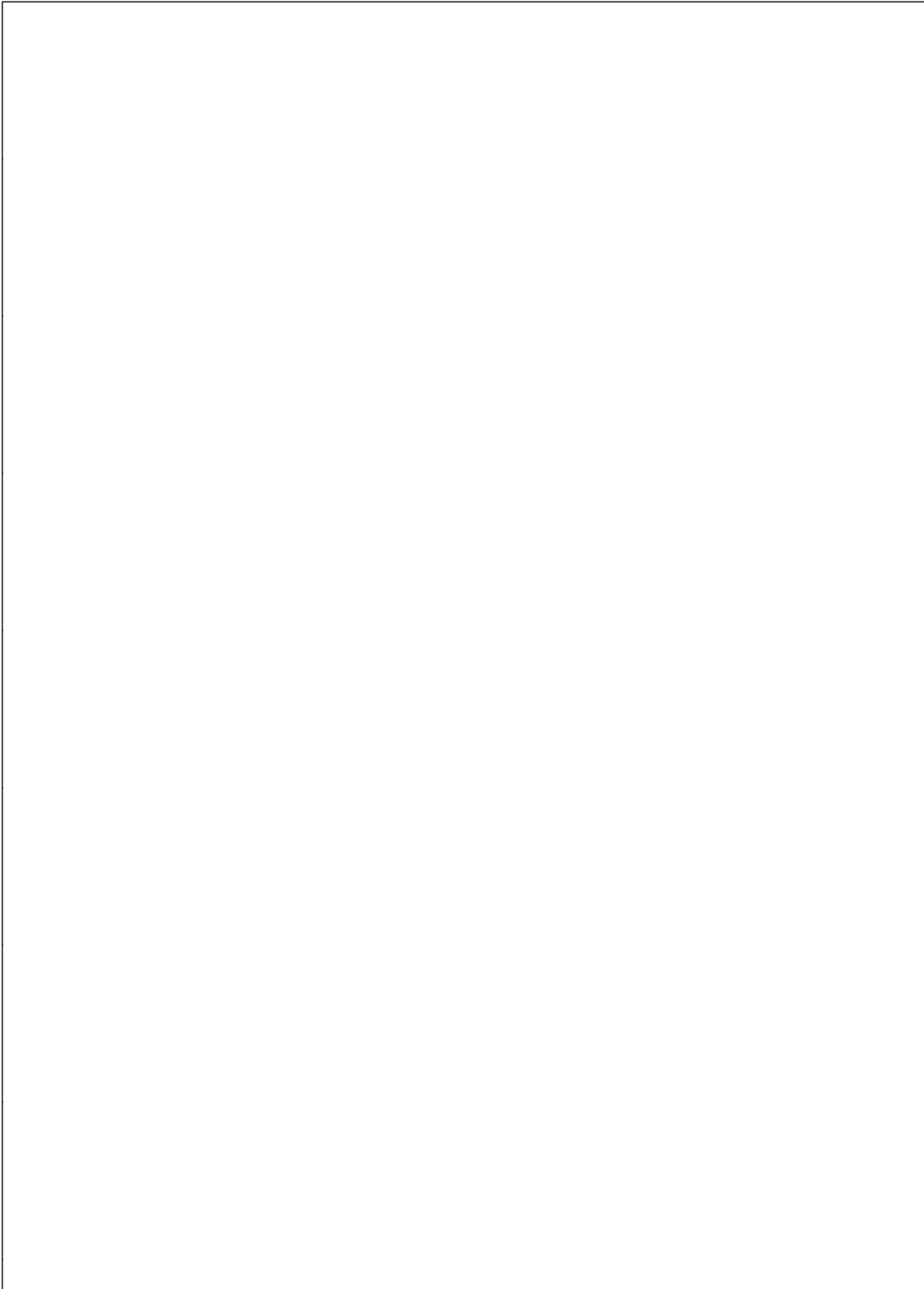

Physical Dimensions inches (millimeters)

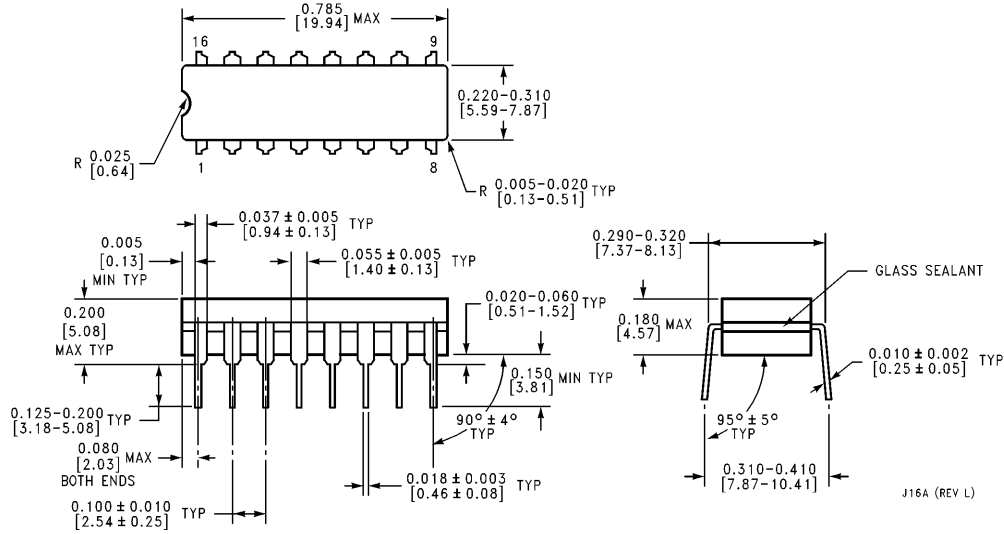

Ceramic Dual-In-Line Package (J)
Order Number DS26LS31CJ or DS26LS31MJ
NS Package Number J16A

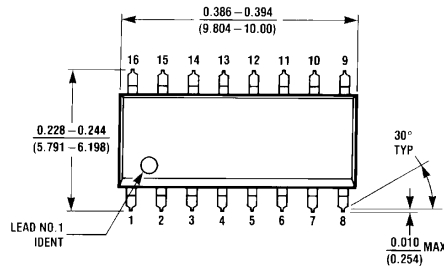

Small Outline Package (M)
Order Number DS26LS31CM
NS Package Number M16A

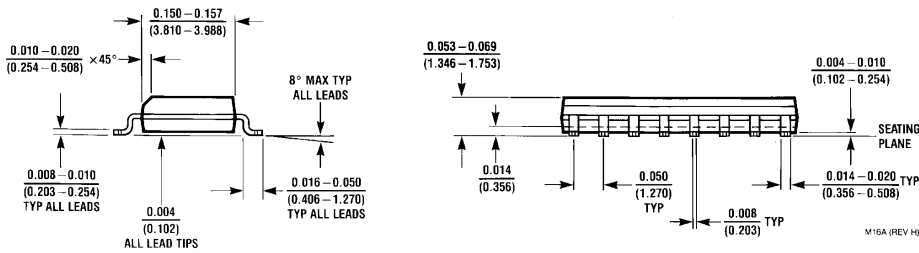

Physical Dimensions inches (millimeters) (Continued)

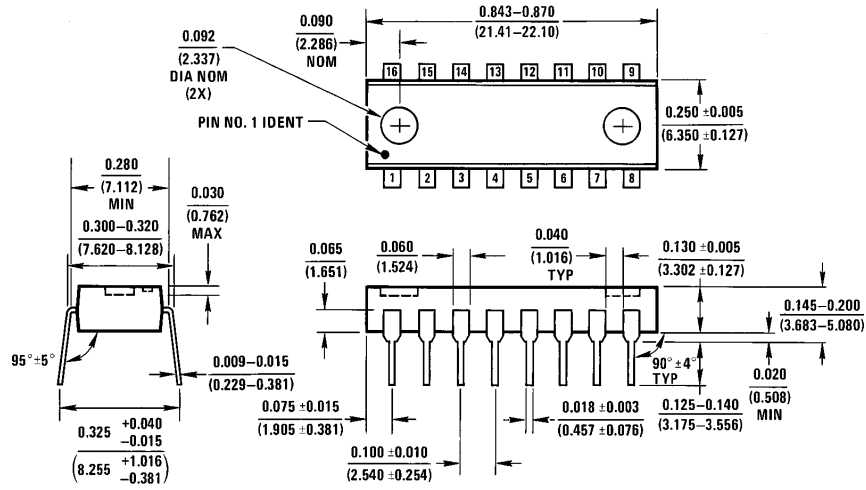

Molded Dual-In-Line Package (N)
Order Number DS26LS31CN
NS Package Number N16A

N16A (REV E)

Physical Dimensions inches (millimeters) (Continued)

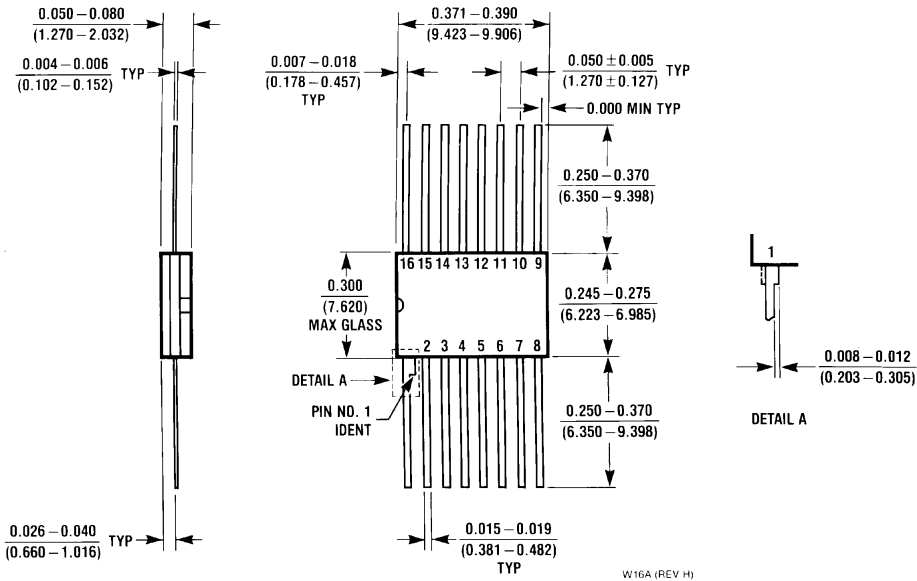

**16 Lead Ceramic Flatpak (F)
NS Package Number W16A**

W16A (REV. H)

LIFE SUPPORT POLICY

NATIONAL'S PRODUCTS ARE NOT AUTHORIZED FOR USE AS CRITICAL COMPONENTS IN LIFE SUPPORT DEVICES OR SYSTEMS WITHOUT THE EXPRESS WRITTEN APPROVAL OF THE PRESIDENT OF NATIONAL SEMICONDUCTOR CORPORATION. As used herein:

1. Life support devices or systems are devices or systems which, (a) are intended for surgical implant into the body, or (b) support or sustain life, and whose failure to perform, when properly used in accordance with instructions for use provided in the labeling, can be reasonably expected to result in a significant injury to the user.
2. A critical component is any component of a life support device or system whose failure to perform can be reasonably expected to cause the failure of the life support device or system, or to affect its safety or effectiveness.



National Semiconductor Corporation
1111 West Bardin Road
Arlington, TX 76017
Tel: 1(800) 272-9959
Fax: 1(800) 737-7018

<http://www.national.com>

National Semiconductor Europe

Fax: +49 (0) 180-530 85 86
Email: europe.support@nsc.com
Deutsch Tel: +49 (0) 180-530 85 85
English Tel: +49 (0) 180-532 78 32
Français Tel: +49 (0) 180-532 93 58
Italiano Tel: +49 (0) 180-534 16 80

National Semiconductor Hong Kong Ltd.

19th Floor, Straight Block,
Ocean Centre, 5 Canton Rd.
Tsimshatsui, Kowloon
Hong Kong
Tel: (852) 2737-1600
Fax: (852) 2736-9960

National Semiconductor Japan Ltd.

Tel: 81-043-299-2308
Fax: 81-043-299-2408