

## DS36C280

### Slew Rate Controlled CMOS EIA-RS-485 Transceiver

#### General Description

The DS36C280 is a low power differential bus/line transceiver designed to meet the requirements of RS-485 Standard for multipoint data transmission. In addition, it is compatible with TIA/EIA-422-B.

The slew rate control feature allows the user to set the driver rise and fall times by using an external resistor. Controlled edge rates can reduce switching EMI.

The CMOS design offers significant power savings over its bipolar and ALS counterparts without sacrificing ruggedness against ESD damage. The device is ideal for use in battery powered or power conscious applications.  $I_{CC}$  is specified at 500  $\mu$ A maximum.

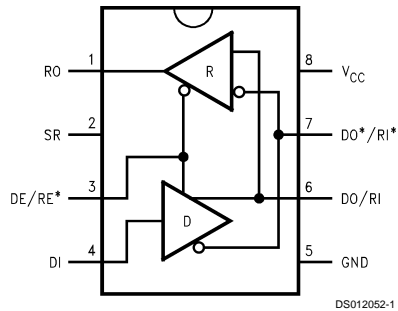
The driver and receiver outputs feature TRI-STATE® capability. The driver outputs operate over the entire common mode range of  $-7V$  to  $+12V$ . Bus contention or fault situations are handled by a thermal shutdown circuit, which forces the driver outputs into the high impedance state.

The receiver incorporates a fail safe circuit which guarantees a high output state when the inputs are left open (Note 1).

#### Features

- 100% RS-485 compliant
  - Guaranteed RS-485 device interoperation
- Low power CMOS design:  $I_{CC}$  500  $\mu$ A max
- Adjustable slew rate control
  - Minimizes EMI affects
- Built-in power up/down glitch-free circuitry
  - Permits live transceiver insertion/displacement
- DIP and SOIC packages available
- Industrial temperature range:  $-40^{\circ}C$  to  $+85^{\circ}C$
- On-board thermal shutdown circuitry
  - Prevents damage to the device in the event of excessive power dissipation
- Wide common mode range:  $-7V$  to  $+12V$
- Receiver open input fail-safe (Note 1)
- $1/4$  unit load (DS36C280):  $\geq 128$  nodes
- $1/2$  unit load (DS36C280T):  $\geq 64$  nodes
- ESD (human body model):  $\geq 2$  kV

#### Connection and Logic Diagram



Order Number DS36C280TM, DS36C280TN  
 DS36C280M and DS36C280N  
 See NS Package Number M08A or N08E

#### Truth Table

DRIVER SECTION			
DE/RE*	DI	DO/RI	DO*/RI*
H	H	H	L
H	L	L	H
L	X	Z	Z
RECEIVER SECTION			
DE/RE*	RI-RI*	RO	
L	$\geq +0.2V$	H	
L	$\leq -0.2V$	L	
H	X	Z	
L	OPEN (Note 1)	H	

Note 1: Non-terminated, Open Inputs only

## Absolute Maximum Ratings (Note 2)

If Military/Aerospace specified devices are required, please contact the National Semiconductor Sales Office/Distributors for availability and specifications.

Supply Voltage ( $V_{CC}$ )	+12V
Input Voltage (DE/RE*, & DI)	-0.5V to ( $V_{CC} + 0.5V$ )
Common Mode ( $V_{CM}$ )	
Driver Output/Receiver Input	±15V
Input Voltage (DO/RI, DO*/RI*)	±14V
Receiver Output Voltage	-0.5V to ( $V_{CC} + 0.5V$ )
Maximum Package Power Dissipation @ +25°C	
M Package 1190 mW, derate	9.5 mW/°C above +25°C
N Package 794 mW, derate	6.0 mW/°C above +25°C

Storage Temperature Range	-65°C to +150°C
Lead Temperature (Soldering 4 sec.)	+260°C

## Recommended Operating Conditions

	Min	Typ	Max	Units
Supply Voltage ( $V_{CC}$ )	+4.75	+5.0	+5.25	V
Bus Voltage	-7		+12	V
Operating Free Air Temperature ( $T_A$ )				°C
DS36C280T	-40	+25	+85	°C
DS36C280	0	+25	+70	°C

## Electrical Characteristics (Notes 3, 4)

Over Supply Voltage and Operating Temperature ranges, unless otherwise specified

Symbol	Parameter	Conditions	Reference	Min	Typ	Max	Units	
<b>DIFFERENTIAL DRIVER CHARACTERISTICS</b>								
$V_{OD1}$	Differential Output Voltage	$I_O = 0$ mA (No Load)	(422) (485)	1.5		5.0	V	
$V_{OD0}$	Output Voltage	$I_O = 0$ mA		0		5.0	V	
$V_{OD0^*}$	Output Voltage	(Output to GND)		0		5.0	V	
$V_{OD2}$	Differential Output Voltage (Termination Load)	$R_L = 50\Omega$ $R_L = 27\Omega$	(422) <i>Figure 1</i> (485)	2.0	2.8		V	
$\Delta V_{OD2}$	Balance of $V_{OD2}$ $ V_{OD2} - V_{OD2^*} $	$R_L = 27\Omega$ or $50\Omega$	(Note 5) (422, 485)	-0.2	0.1	+0.2	V	
$V_{OD3}$	Differential Output Voltage (Full Load)	$R1 = 54\Omega, R2 = 375\Omega$ $V_{TEST} = -7V$ to $+12V$	<i>Figure 2</i>	1.5	2.0	5.0	V	
$V_{OC}$	Driver Common Mode Output Voltage	$R_L = 27\Omega$ $R_L = 50\Omega$	(485) <i>Figure 1</i> (422)	0		3.0	V	
$\Delta V_{OC}$	Balance of $V_{OC}$ $ V_{OC} - V_{OC^*} $	$R_L = 27\Omega$ or $R_L = 50\Omega$	(Note 5) (422, 485)	-0.2		+0.2	V	
$I_{OSD}$	Driver Output Short-Circuit Current	$V_O = +12V$ $V_O = -7V$	(485) <i>Figure 4</i> (485)		200	+250	mA	
					-190	-250	mA	
<b>RECEIVER CHARACTERISTICS</b>								
$V_{TH}$	Differential Input High Threshold Voltage	$V_O = V_{OH}, I_O = -0.4$ mA $-7V \leq V_{CM} \leq +12V$	(Note 6) (422, 485)		+0.035	+0.2	V	
$V_{TL}$	Differential Input Low Threshold Voltage	$V_O = V_{OL}, I_O = 0.4$ mA $-7V \leq V_{CM} \leq +12V$		-0.2	-0.035		V	
$V_{HST}$	Hysteresis	$V_{CM} = 0V$			70		mV	
$R_{IN}$	Input Resistance	$-7V \leq V_{CM} \leq +12V$	DS36C280T	24	68		k $\Omega$	
$R_{IN}$	Input Resistance	$-7V \leq V_{CM} \leq +12V$	DS36C280	48	68		k $\Omega$	
$I_{IN}$	Line Input Current (Note 8)	Other Input = 0V DE = $V_{IL}$ , RE* = $V_{IL}$ $V_{CC} = 4.75$ to $5.25$ or 0V	DS36C280	$V_{IN} = +12V$ $V_{IN} = -7V$	0	0.19	0.25	mA
			DS36C280T	$V_{IN} = +12V$ $V_{IN} = -7V$	0	0.19	0.5	mA
				$V_{IN} = +12V$ $V_{IN} = -7V$	0	0.19	0.25	mA
				$V_{IN} = +12V$ $V_{IN} = -7V$	0	-0.1	-0.4	mA
$I_{ING}$	Line Input Current Glitch (Note 8)	Other Input = 0V DE = $V_{IL}$ , RE* = $V_{IL}$ $V_{CC} = +3.0V$ or 0V $T_A = 25^\circ C$	DS36C280	$V_{IN} = +12V$ $V_{IN} = -7V$	0	0.19	0.25	mA
			DS36C280T	$V_{IN} = +12V$ $V_{IN} = -7V$	0	0.19	0.5	mA
				$V_{IN} = +12V$ $V_{IN} = -7V$	0	-0.1	-0.4	mA
$I_B$	Input Balance Test	$RS = 500\Omega$	(422) (Note 10)			±400	mV	
$V_{OH}$	High Level Output Voltage	$I_{OH} = -4$ mA, $V_{ID} = +0.2V$	RO	3.5	4.6		V	
$V_{OL}$	Low Level Output Voltage	$I_{OL} = +4$ mA, $V_{ID} = -0.2V$	<i>Figure 11</i>		0.3	0.5	V	

## Electrical Characteristics (Notes 3, 4) (Continued)

Over Supply Voltage and Operating Temperature ranges, unless otherwise specified

Symbol	Parameter	Conditions	Reference	Min	Typ	Max	Units	
<b>RECEIVER CHARACTERISTICS</b>								
$I_{OSR}$	Short Circuit Current	$V_O = \text{GND}$	RO	7	35	85	mA	
$I_{OZR}$	TRI-STATE Leakage Current	$V_O = 0.4V \text{ to } 2.4V$				$\pm 1$	$\mu A$	
<b>DEVICE CHARACTERISTICS</b>								
$V_{IH}$	High Level Input Voltage		DE/RE*, DI	2.0		$V_{CC}$	V	
$V_{IL}$	Low Level Input Voltage			GND		0.8		V
$I_{IH}$	High Level Input Current	$V_{IH} = V_{CC}$				2		$\mu A$
$I_{IL}$	Low Level Input Current	$V_{CC} = 5.0V$		$V_{IL} = 0V$			-2	$\mu A$
		$V_{CC} = +3.0V$				-2	$\mu A$	
		SR = 0V	SR				-1	mA
$I_{CCR}$	Power Supply Current (No Load)	Driver OFF, Receiver ON	$V_{CC}$		200	500	$\mu A$	
$I_{CCD}$		Driver ON, Receiver OFF			200	500	$\mu A$	

## Switching Characteristics (Notes 4, 9, 11)

Over Supply Voltage and Operating Temperature ranges, unless otherwise specified

Symbol	Parameter	Conditions	Reference	Min	Typ	Max	Units
<b>DRIVER CHARACTERISTICS</b>							
$t_{PHLD}$	Differential Propagation Delay High to Low	$R_L = 54\Omega, C_L = 100 \text{ pF}$	Figures 5, 6	10	399	1000	ns
$t_{PLHD}$	Differential Propagation Delay Low to High			10	400	1000	ns
$t_{SKD}$	Differential Skew $ t_{PHLD} - t_{PLHD} $			0	1	10	ns
$t_r$	Rise Time	SR = Open			2870		ns
$t_f$	Fall Time				3070		ns
$t_r$	Rise Time	SR = 100 k $\Omega$			1590		ns
$t_f$	Fall Time				1640		ns
$t_r$	Rise Time	SR = Short		100	337	1000	ns
$t_f$	Fall Time			100	348	1000	ns
$t_{PHZ}$	Disable Time High to Z	$C_L = 15 \text{ pF}$	Figures 7, 8		1100	2000	ns
$t_{PLZ}$	Disable Time Low to Z		Figures 9, 10		500	800	ns
$t_{PZH}$	Enable Time Z to High	$C_L = 100 \text{ pF}$	Figures 7, 8		300	500	ns
$t_{PZL}$	Enable Time Z to Low		Figures 9, 10		300	500	ns
<b>RECEIVER CHARACTERISTICS</b>							
$t_{PHL}$	Propagation Delay High to Low	$C_L = 15 \text{ pF}$	Figures 12, 13	30	210	400	ns
$t_{PLH}$	Propagation Delay Low to High			30	190	400	ns
$t_{SK}$	Skew, $ t_{PHL} - t_{PLH} $			0	20	50	ns
$t_{PLZ}$	Output Disable Time	$C_L = 15 \text{ pF}$	Figures 14, 15, 16		50	150	ns
$t_{PHZ}$					55	150	ns
$t_{PZL}$	Output Enable Time				40	150	ns
$t_{PZH}$					45	150	ns

**Note 2:** "Absolute Maximum Ratings" are those values beyond which the safety of the device cannot be guaranteed. They are not meant to imply that the devices should be operated at these limits. The table of "Electrical Characteristics" specifies conditions of device operation.

**Note 3:** Current into device pins is defined as positive. Current out of device pins is defined as negative. All voltages are referenced to ground except  $V_{OD1}$  and  $V_{OD2}$ .

**Note 4:** All typicals are given for:  $V_{CC} = +5.0V, T_A = +25^\circ C$ .

**Note 5:** Delta  $|V_{OD2}|$  and Delta  $|V_{OC}|$  are changes in magnitude of  $V_{OD2}$  and  $V_{OC}$ , respectively, that occur when input changes state.

## Switching Characteristics (Notes 4, 9, 11) (Continued)

**Note 6:** Threshold parameter limits specified as an algebraic value rather than by magnitude.

**Note 7:** Hysteresis defined as  $V_{HST} = V_{TH} - V_{TL}$ .

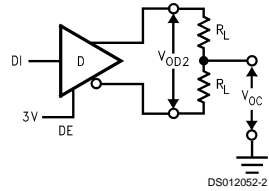
**Note 8:**  $I_{IN}$  includes the receiver input current and driver TRI-STATE leakage current.

**Note 9:**  $C_L$  includes probe and jig capacitance.

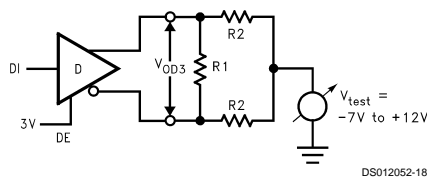
**Note 10:** For complete details of test, see RS-485.

**Note 11:** SR = GND for all Switching Characteristics unless otherwise specified.

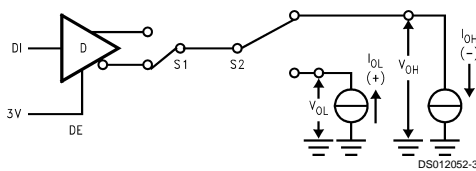
## Parameter Measurement Information



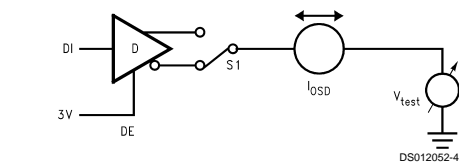
**FIGURE 1. Driver  $V_{OD2}$  and  $V_{OC}$**



**FIGURE 2. Driver  $V_{OD3}$**

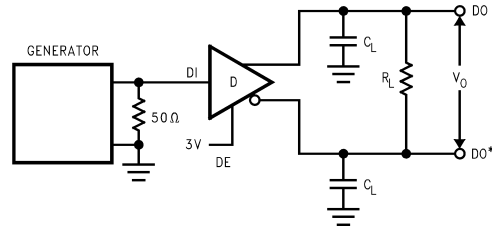


**FIGURE 3. Driver  $V_{OH}$  and  $V_{OL}$**

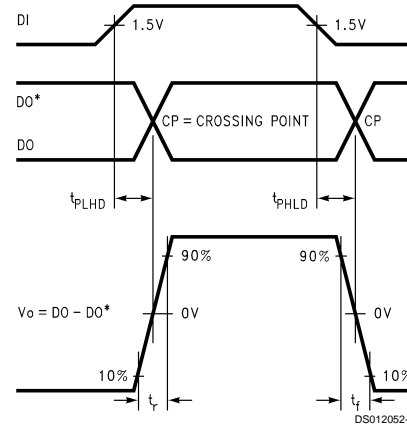


$V_{test} = -7V$  to  $+12V$

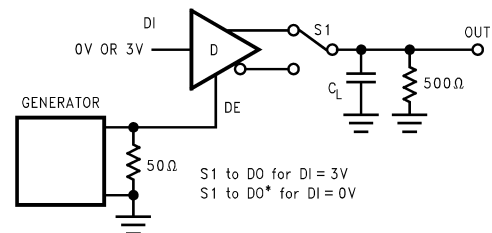
**FIGURE 4. Driver  $I_{OSD}$**



**FIGURE 5. Driver Differential Propagation Delay Test Circuit**

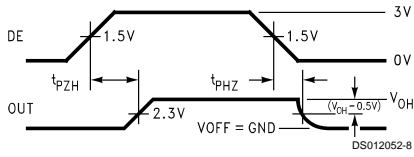


**FIGURE 6. Driver Differential Propagation Delays and Differential Rise and Fall Times**

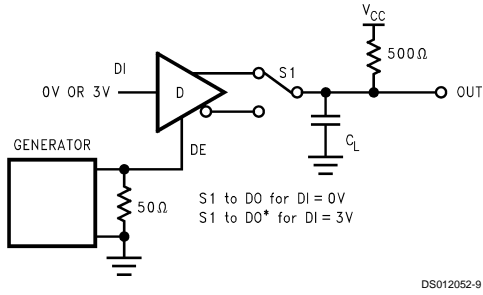


**FIGURE 7. TRI-STATE Test Circuit ( $t_{PZH}$ ,  $t_{PHZ}$ )**

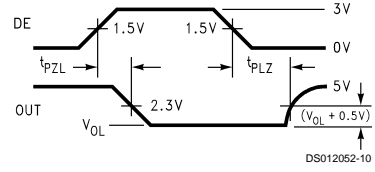
**Parameter Measurement Information** (Continued)



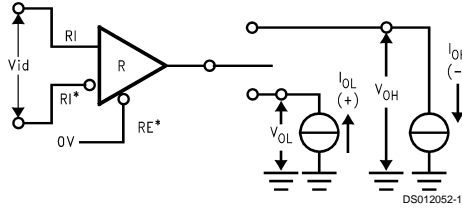
**FIGURE 8. TRI-STATE Waveforms ( $t_{PZH}$ ,  $t_{PHZ}$ )**



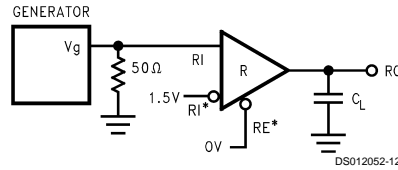
**FIGURE 9. TRI-STATE Test Circuit ( $t_{PZL}$ ,  $t_{PLZ}$ )**



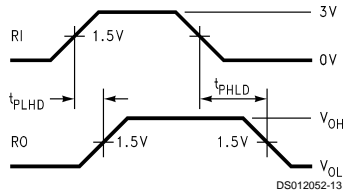
**FIGURE 10. TRI-STATE Waveforms ( $t_{PZL}$ ,  $t_{PLZ}$ )**



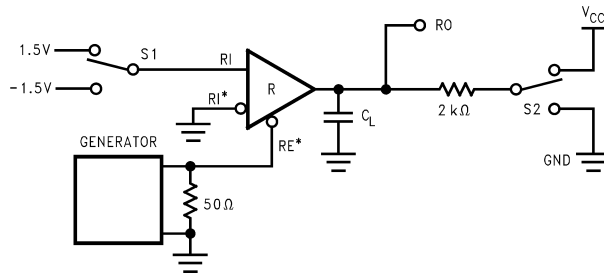
**FIGURE 11. Receiver  $V_{OH}$  and  $V_{OL}$**



**FIGURE 12. Receiver Differential Propagation Delay Test Circuit**



**FIGURE 13. Receiver Differential Propagation Delay Waveforms**



**FIGURE 14. Receiver TRI-STATE Test Circuit**

## Parameter Measurement Information (Continued)

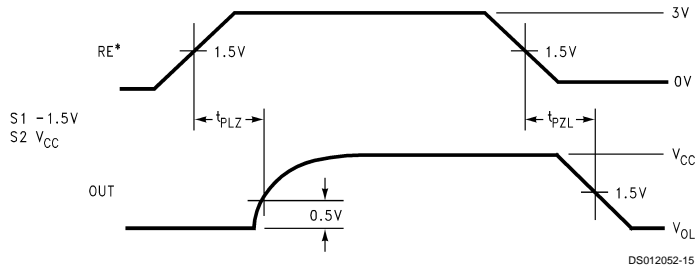


FIGURE 15. Receiver Enable and Disable Waveforms ( $t_{PLZ}$ ,  $t_{PZL}$ )

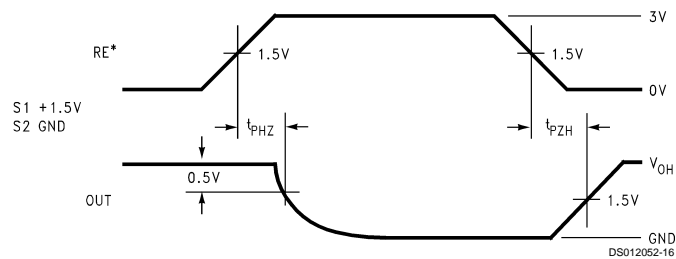


FIGURE 16. Receiver Enable and Disable Waveforms ( $t_{PHZ}$ ,  $t_{PZH}$ )

## Typical Application Information

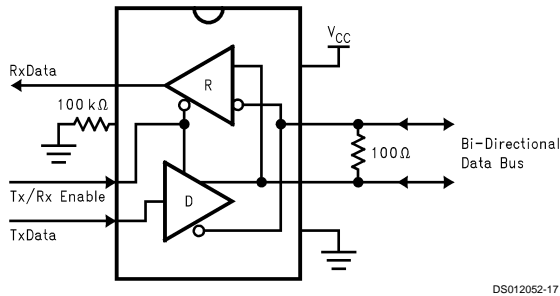


FIGURE 17. Typical Pin Connection

TABLE 1. Device Pin Descriptions

Pin #	Name	Description
1	RO	Receiver Output: When DE/RE* (Receiver Enable) is LOW, the receiver is enabled (ON), if DO/RI $\geq$ DO*/RI* by 200 mV, RO will be HIGH. If DO/RI $\leq$ DO*/RI* by 200 mV, RO will be LOW. Additionally RO will be HIGH for OPEN (Non-terminated) inputs.
2	SR	Slew Rate Control: A resistor connected to Ground controls the Driver Output rising and falling edge rates.
3	DE/RE*	Combined Driver and Receiver Output Enable: When signal is LOW the receiver output is enabled and the driver outputs are in TRI-STATE (OFF). When signal is HIGH, the receiver output is in TRI-STATE (OFF) and the driver outputs are enabled.
4	DI	Driver Input: When DE/RE* is HIGH, the driver is enabled, if DI is LOW, then DO/RI will be LOW and DO*/RI* will be HIGH. If DI is HIGH, then DO/RI is HIGH and DO*/RI* is LOW.

## Typical Application Information (Continued)

TABLE 1. Device Pin Descriptions (Continued)

Pin #	Name	Description
5	GND	Ground Connection
6	DO/RI	Driver Output/Receiver Input, 485 Bus Pin.
7	DO*/RI*	Driver Output/Receiver Input, 485 Bus Pin.
8	V <sub>CC</sub>	Positive Power Supply Connection: Recommended operating range for V <sub>CC</sub> is +4.75V to +5.25V.

### Unit Load

A unit load for a RS-485 receiver is defined by the input current versus the input voltage curve. The gray shaded region is the defined operating range from  $-7V$  to  $+12V$ . The top border extending from  $-3V$  at  $0\text{ mA}$  to  $+12V$  at  $+1\text{ mA}$  is defined as one unit load. Likewise, the bottom border extending from  $+5V$  at  $0\text{ mA}$  to  $-7V$  at  $-0.8\text{ mA}$  is also defined as one unit load (see Figure 18). A RS-485 driver is capable of driving up to 32 unit loads. This allows up to 32 nodes on a single bus. Although sufficient for many applications, it is sometime desirable to have even more nodes. For example an aircraft that has 32 rows with 4 seats per row could benefit from having 128 nodes on one bus. This would allow signals to be transferred to and from each individual seat to 1 main station. Usually there is one or two less seats in the last row of the aircraft near the restrooms and food storage area. This frees the node for the main station.

The DS36C278, the DS36C279, and the DS36C280 all have  $\frac{1}{2}$  unit load and  $\frac{1}{4}$  unit load (UL) options available. These devices will allow up to 64 nodes or 128 nodes guaranteed over temperature depending upon which option is selected. The  $\frac{1}{2}$  UL option is available in industrial temperature and the  $\frac{1}{4}$  UL is available in commercial temperature.

First, for a  $\frac{1}{2}$  UL device the top and bottom borders shown in Figure 18 are scaled. Both  $0\text{ mA}$  reference points at  $+5V$  and  $-3V$  stay the same. The other reference points are  $+12V$  at  $+0.5\text{ mA}$  for the top border and  $-7V$  at  $-0.4\text{ mA}$  for the bottom border (see Figure 18). Second, for a  $\frac{1}{4}$  UL device the top and bottom borders shown in Figure 18 are scaled also. Again, both  $0\text{ mA}$  reference points at  $+5V$  and  $-3V$  stay the same. The other reference points are  $+12V$  at  $+0.25\text{ mA}$  for the top border and  $-7V$  at  $-0.2\text{ mA}$  for the bottom border (see Figure 18).

The advantage of the  $\frac{1}{2}$  UL and  $\frac{1}{4}$  UL devices is the increased number of nodes on one bus. In a single master multi-slave type of application were the number of slaves exceeds 32, the DS36C278/279/280 may save in the cost of extra devices like repeaters, extra media like cable, and/or extra components like resistors.

The DS36C279 and DS36C280 have addition feature which offer more advantages. The DS36C279 has an automatic sleep mode function for power conscious applications. The

DS36C280 has a slew rate control for EMI conscious applications. Refer to the sleep mode and slew rate control portion of the application information section in the corresponding datasheet for more information on these features.

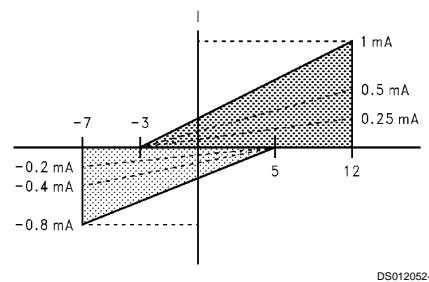


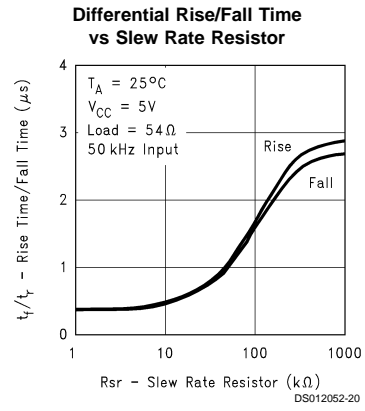
FIGURE 18. Input Current vs Input Voltage Operating Range

### Slew Rate Control

The DS36C280 features an adjustable slew rate control. This feature allows more control over EMI levels than tradition fixed edge rate devices. The slew rate control may be adjusted with or without any external components. The DS36C280 offers both low power ( $I_{CC}$   $500\text{ }\mu\text{A}$  max) and low EMI for an RS-485 interface.

The slew rate control is located at pin two of the device and only controls the driver output edges. The slew rate control pin (SR) may be left open or shorted to ground, with or without a resistor. When the SR pin is shorted to ground without a resistor, the driver output edges will transition typically  $350\text{ ns}$ . When the SR pin is left open, the driver output edges will transition typically  $3\text{ }\mu\text{s}$ . When the SR pin is shorted to ground with a resistor, the driver output edges will transition between  $350\text{ ns}$  and  $3\text{ }\mu\text{s}$  depending on the resistor value. Refer to the slew rate versus resistor value curve in this datasheet for determining resistor values and expected typical slew rate value. Please note, when slowing the edge rates of the device (see Figure 19) will decrease the maximum data rate also.

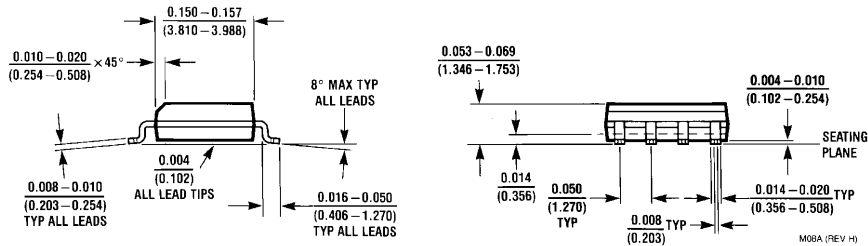
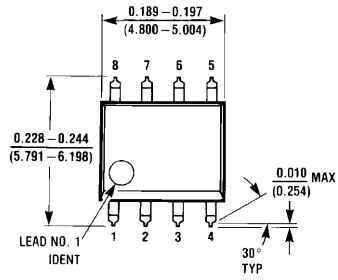
## Slew Rate Control (Continued)



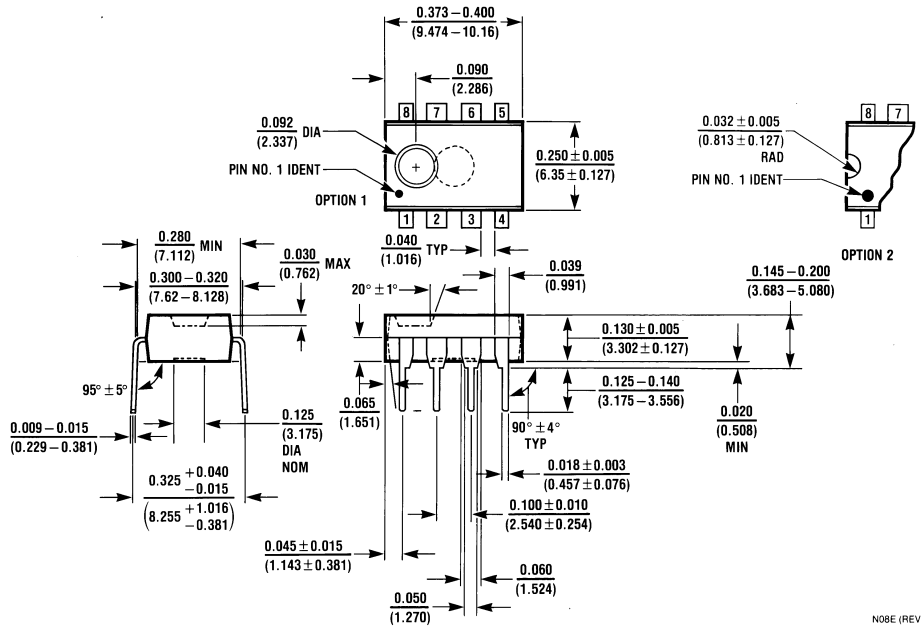
**FIGURE 19. Slew Rate Resistor vs Rise/Fall Time**



**Physical Dimensions** inches (millimeters) unless otherwise noted



**8-Lead (0.150" Wide) Molded Small Outline Package, JEDEC**  
**Order Number DS36C280TM**  
**NS Package Number M08A**



**8-Lead (0.300" Wide) Molded Dual-In-Line Package**  
**Order Number DS36C280TN**  
**NS Package Number N08E**

**LIFE SUPPORT POLICY**

NATIONAL'S PRODUCTS ARE NOT AUTHORIZED FOR USE AS CRITICAL COMPONENTS IN LIFE SUPPORT DEVICES OR SYSTEMS WITHOUT THE EXPRESS WRITTEN APPROVAL OF THE PRESIDENT OF NATIONAL SEMICONDUCTOR CORPORATION. As used herein:

1. Life support devices or systems are devices or systems which, (a) are intended for surgical implant into the body, or (b) support or sustain life, and whose failure to perform when properly used in accordance with instructions for use provided in the labeling, can be reasonably expected to result in a significant injury to the user.
2. A critical component is any component of a life support device or system whose failure to perform can be reasonably expected to cause the failure of the life support device or system, or to affect its safety or effectiveness.



**National Semiconductor Corporation**  
Americas  
Tel: 1-800-272-9959  
Fax: 1-800-737-7018  
Email: support@nsc.com

[www.national.com](http://www.national.com)

**National Semiconductor Europe**  
Fax: +49 (0) 1 80-530 85 86  
Email: europe.support@nsc.com  
Deutsch Tel: +49 (0) 1 80-530 85 85  
English Tel: +49 (0) 1 80-532 78 32  
Français Tel: +49 (0) 1 80-532 93 58  
Italiano Tel: +49 (0) 1 80-534 16 80

**National Semiconductor Asia Pacific Customer Response Group**  
Tel: 65-2544466  
Fax: 65-2504466  
Email: sea.support@nsc.com

**National Semiconductor Japan Ltd.**  
Tel: 81-3-5639-7560  
Fax: 81-3-5639-7507