

LM4130

Precision Micropower Low Dropout Voltage Reference

General Description

The LM4130 family of precision voltage references performs comparable to the best laser-trimmed bipolar references, but in cost effective CMOS technology. Key to this break through is the use of EEPROM registers for correction of curvature, tempco, and accuracy on a CMOS bandgap architecture that allows package level programming to overcome assembly shift. The shifts in voltage accuracy and tempco during assembly of die into plastic packages limit the accuracy of references trimmed with laser techniques.

Unlike other LDO references, the LM4130 requires no output capacitor. Neither is a buffer amplifier required, even with loads up to 20mA. These advantages and the SOT23 packaging are important for cost-critical and space-critical applications.

Series references provide lower power consumption than shunt references, since they don't have to idle the maximum possible load current under no load conditions. This advantage, the low quiescent current (75µA), and the low dropout voltage(275mV) make the LM4130 ideal for battery-powered solutions.

The LM4130 is available in five grades (A, B, C, D and E) for greater flexibility. The best grade devices (A) have an initial accuracy of 0.05% with guaranteed temperature coefficient of 10ppm/°C or less, while the lowest grade parts (E) have an initial accuracy of 0.5% and a tempco of 30ppm/°C.

Features

- Small SOT23-5 package
- High output voltage accuracy 0.05%

- Low Temperature Coefficient 10 ppm/°C
- Stable with capacitive loads to 2.2µF
- Low dropout voltage ≤275 mV @ 10 mA
- Supply Current ≤75 µA
- Full accuracy -40°C to 85°C
- Extended operation to 125°C
- Excellent load and line regulation
- Output current 20 mA
- Output impedance < 1Ω
- Voltage options: 2.500V and 4.096V

Applications Summary

- Portable, battery powered equipment
- Instrumentation and process control
- Automotive & Industrial
- Test equipment
- Data acquisition systems
- Precision regulators
- Battery chargers
- Base stations
- Communications
- Medical equipment
- Servo systems

Connection Diagram and Pin Configuration

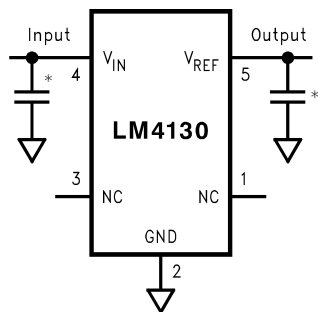

10104601

*Optional, Recommended for improved transient response and input noise reduction.
(See Application Information)

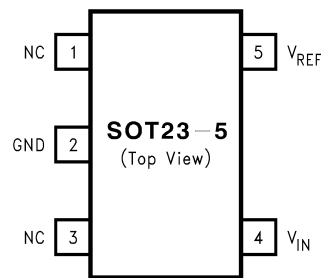

10104602

Refer to the Ordering Information Table in this Data Sheet for Specific Part Number

SOT23-5 Surface Mount Package

Ordering Information

Industrial Temperature Range (-40°C to $+85^{\circ}\text{C}$)

Initial Output Voltage Accuracy at 25°C And Temperature Coefficient	LM4130 Supplied as 1000 Units, Tape and Reel	LM4130 Supplied as 3000 Units, Tape and Reel	Part Marking
0.05%, 10 ppm/ $^{\circ}\text{C}$ max (A grade)	LM4130AIM5-2.5	LM4130AIM5X-2.5	R03A
	LM4130AIM5-4.1	LM4130AIM5X-4.1	R04A
0.2%, 10 ppm/ $^{\circ}\text{C}$ max (B grade)	LM4130BIM5-2.5	LM4130BIM5X-2.5	R03B
	LM4130BIM5-4.1	LM4130BIM5X-4.1	R04B
0.1%, 20 ppm/ $^{\circ}\text{C}$ max (C grade)	LM4130CIM5-2.5	LM4130CIM5X-2.5	R03C
	LM4130CIM5-4.1	LM4130CIM5X-4.1	R04C
0.4%, 20 ppm/ $^{\circ}\text{C}$ max (D grade)	LM4130DIM5-2.5	LM4130DIM5X-2.5	R03D
	LM4130DIM5-4.1	LM4130DIM5X-4.1	R04D
0.5%, 30 ppm/ $^{\circ}\text{C}$ max (E grade)	LM4130EIM5-2.5	LM4130EIM5X-2.5	R03E
	LM4130EIM5-4.1	LM4130EIM5X-4.1	R04E

SOT23-5 Package Marking Information

Only four fields of marking are possible on the SOT23-5's small surface. This table gives the meaning of the four fields.

Field Information
First Field: R = Reference
Second and Third Field: 03 = 2.50V Voltage Option 04 = 4.096V Voltage Option
Fourth Field: A-E = Initial Reference Voltage Tolerance and Temperature Coefficient A = $\pm 0.05\%$, 10ppm/ $^{\circ}\text{C}$ B = $\pm 0.2\%$, 10ppm/ $^{\circ}\text{C}$ C = $\pm 0.1\%$, 20ppm/ $^{\circ}\text{C}$ D = $\pm 0.4\%$, 20ppm/ $^{\circ}\text{C}$ E = $\pm 0.5\%$, 30ppm/ $^{\circ}\text{C}$

Absolute Maximum Ratings (Note 1)

If Military/Aerospace specified devices are required, please contact the National Semiconductor Sales Office/Distributors for availability and specifications.

Maximum Voltage on any Input	-0.3V to 6V
Output Short-Circuit Duration	Indefinite
Power Dissipation ($T_A = 25^\circ\text{C}$)	350 mW
(Note 2)	
ESD Susceptibility (Note 3)	
Human Body Model	2 kV

Machine Model	200V
Lead Temperature:	
Soldering, (10 sec.)	+260°C
Vapor Phase (60 sec.)	+215°C
Infrared (15 sec.)	+220°C

Operating Range (Note 1)

Storage Temperature Range	-65°C to +150°C
Operating Temperature Range	-40°C to +85°C

LM4130-2.500**Electrical Characteristics**

Unless otherwise specified $V_{CC} = 5\text{V}$, $I_{LOAD} = 0$, $T_A = 25^\circ\text{C}$. Limits with standard typeface are for $T_A = 25^\circ\text{C}$, and limits in **bold-face type** apply over the operating temperature range.

Symbol	Parameter	Conditions	Min (Note 5)	Typ (Note 4)	Max (Note 5)	Units
V_{REF}	Output Voltage Initial Accuracy LM4130A-2.500 LM4130B-2.500 LM4130C-2.500 LM4130D-2.500 LM4130E-2.500				± 0.05 ± 0.2 ± 0.1 ± 0.4 ± 0.5	%
$TCV_{REF}/^\circ\text{C}$ (Note 6)	Temperature Coefficient LM4130A, B LM4130C, D LM4130E	$0^\circ\text{C} \leq T_A \leq +85^\circ\text{C}$ $-40^\circ\text{C} \leq T_A \leq +85^\circ\text{C}$			10 20 20 30	ppm/°C
$\Delta V_{REF}/\Delta V_{IN}$	Line Regulation	$I_{LOAD} = 100\mu\text{A}$ $V_{REF} + 200\text{ mV} \leq V_{IN} \leq 5.5\text{V}$ $V_{REF} + 400\text{ mV} \leq V_{IN} \leq 5.5\text{V}$		30	100 150	ppm/V
$\Delta V_{REF}/\Delta I_{LOAD}$	Load Regulation	$0\text{ mA} \leq I_{LOAD} \leq 20\text{ mA}$		25	60 80	ppm/mA
ΔV_{REF}	Long-Term Stability (Note 7)	1000 Hrs		50		ppm
	Thermal Hysteresis (Note 8)	$-40^\circ\text{C} \leq T_A \leq +125^\circ\text{C}$		50		
$V_{IN} - V_{REF}$	Dropout Voltage (Note 9)	$I_{LOAD} = 10\text{ mA}$			275 400	mV
V_N	Output Noise Voltage	0.1 Hz to 10 Hz		150		μV_{PP}
I_S	Supply Current			50	75 90	μA
I_{SC}	Short Circuit Current		30		60	mA
					65	

LM4130-4.096

Electrical Characteristics

Unless otherwise specified $V_{CC} = 5.0V$, $I_{LOAD} = 0$ $T_A = 25^\circ C$. Limits with standard typeface are for $T_A = 25^\circ C$, and limits in **boldface type** apply over the operating temperature range.

Symbol	Parameter	Conditions	Min (Note 5)	Typ (Note 4)	Max (Note 5)	Units
V_{REF}	Output Voltage Initial Accuracy LM4130-4.096A LM4130-4.096B LM4130-4.096C LM4130-4.096D LM4130-4.096E				± 0.05 ± 0.2 ± 0.1 ± 0.4 ± 0.5	%
$TCV_{REF}/^\circ C$ (Note 6)	Temperature Coefficient LM4130A, B LM4130C, D LM4130E	$0^\circ C \leq T_A \leq +85^\circ C$ $-40^\circ C \leq T_A \leq +85^\circ C$			10 20 20 30	ppm/ $^\circ C$
$\Delta V_{REF}/\Delta V_{IN}$	Line Regulation	$I_{LOAD} = 100\mu A$ $V_{REF} + 500\text{ mV} \leq V_{IN} \leq 5.5V$		75	250 400	ppm/V
$\Delta V_{REF}/\Delta I_{LOAD}$	Load Regulation	$0\text{ mA} \leq I_{LOAD} \leq 20\text{ mA}$		16	60 80	ppm/mA
ΔV_{REF}	Long-Term Stability (Note 7)	1000 Hrs		50		ppm
	Thermal Hysteresis (Note 8)	$-40^\circ C \leq T_A \leq +125^\circ C$		50		
$V_{IN} - V_{REF}$	Dropout Voltage (Note 9)	$I_{LOAD} = 10\text{ mA}$			275 500	mV
V_N	Output Noise Voltage	0.1 Hz to 10 Hz		245		μV_{PP}
I_S	Supply Current			50	75 90	μA
I_{SC}	Short Circuit Current		30		60 65	mA mA

Note 1: Absolute Maximum Ratings indicate limits beyond which damage to the device may occur. Operating Ratings indicate conditions for which the device is intended to be functional, but do not guarantee specific performance limits. For guaranteed specifications and test conditions, see Electrical Characteristics. The guaranteed specifications apply only for the test conditions listed. Some performance characteristics may degrade when the device is not operated under the listed test conditions.

Note 2: Without PCB copper enhancements. The maximum power dissipation must be de-rated at elevated temperatures and is limited by T_{JMAX} (maximum junction temperature), θ_{J-A} (junction to ambient thermal resistance) and T_A (ambient temperature). The maximum power dissipation at any temperature is: $P_{DissMAX} = (T_{JMAX} - T_A)/\theta_{J-A}$ up to the value listed in the Absolute Maximum Ratings. θ_{J-A} for SOT23-5 package is $220^\circ C/W$, $T_{JMAX} = 125^\circ C$.

Note 3: The human body model is a 100 pF capacitor discharged through a 1.5 k Ω resistor into each pin. The machine model is a 200 pF capacitor discharged directly into each pin.

Note 4: Typical numbers are at $25^\circ C$ and represent the most likely parametric norm.

Note 5: Limits are 100% production tested at $25^\circ C$. Limits over the operating temperature range are guaranteed through correlation using Statistical Quality Control (SQC) methods. The limits are used to calculate National's Average Outgoing Quality Level (AOQL).

Note 6: Temperature coefficient is measured by the "Box" method; i.e., the maximum ΔV_{REF} is divided by the maximum ΔT .

Note 7: Long term stability is V_{REF} @ $25^\circ C$ measured during 1000 hrs.

Note 8: Thermal hysteresis is defined as the change in $+25^\circ C$ output voltage before and after cycling the device from $-40^\circ C$ to $125^\circ C$.

Note 9: Dropout voltage is defined as the minimum input to output differential at which the output voltage drops by 0.5% below the value measured with a 5V input.

LM4130 Typical Performance Characteristics $T_A = 25^\circ\text{C}$, No Load, $V_{IN} = 5.0\text{V}$, unless otherwise noted.

Temperature Drift Characteristics

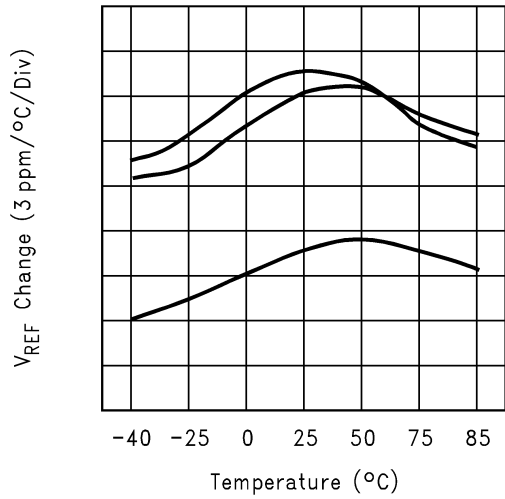

Load Regulation vs Temperature

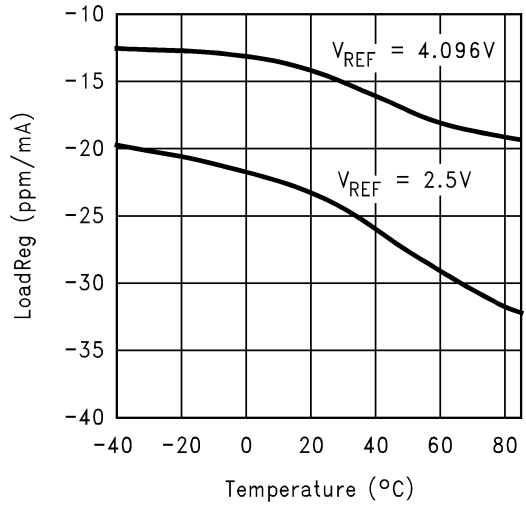

Line Regulation vs Load

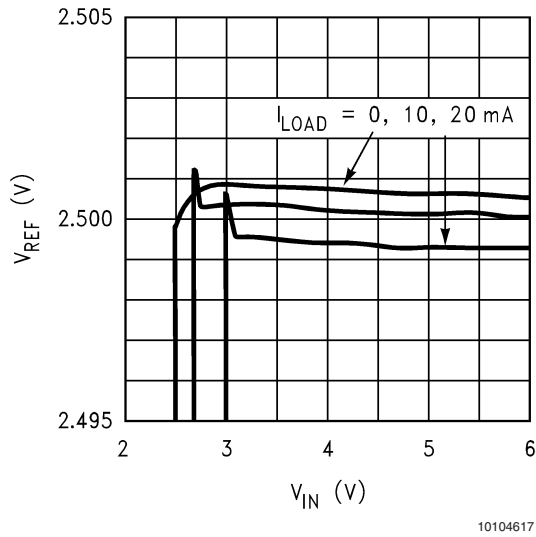

Line Regulation vs Temperature

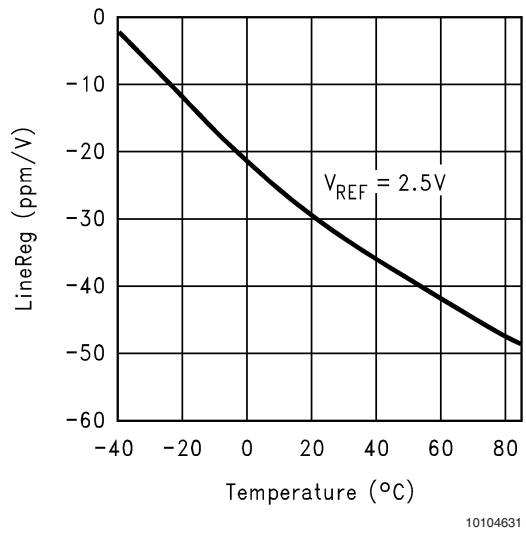

LM4130 Typical Performance Characteristics $T_A = 25^\circ\text{C}$, No Load, $V_{IN} = 5.0\text{V}$, unless otherwise noted. (Continued)

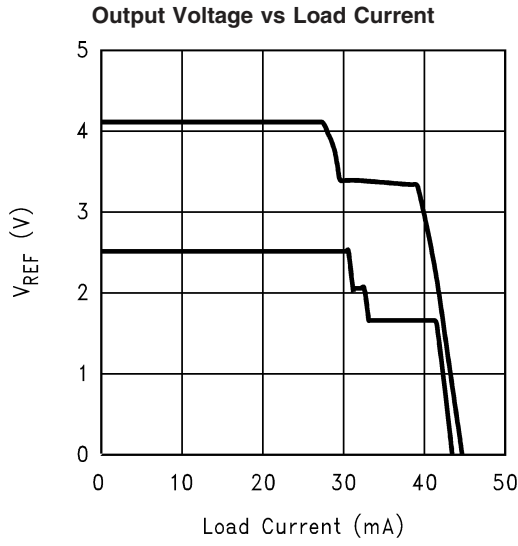

10104621

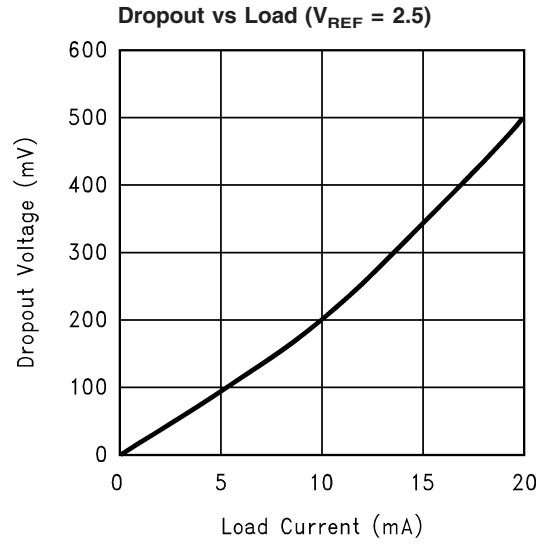

10104642

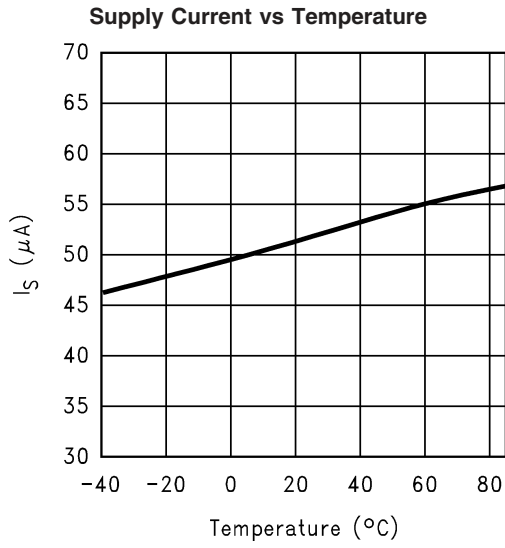

10104629

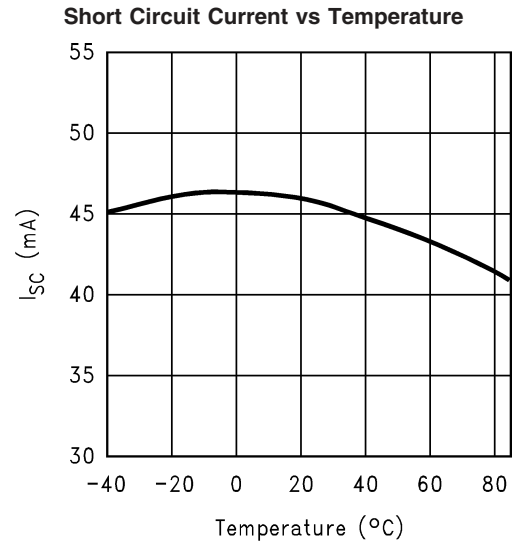

10104628

LM4130 Typical Performance Characteristics $T_A = 25^\circ\text{C}$, No Load, $V_{IN} = 5.0\text{V}$, unless otherwise noted. (Continued)

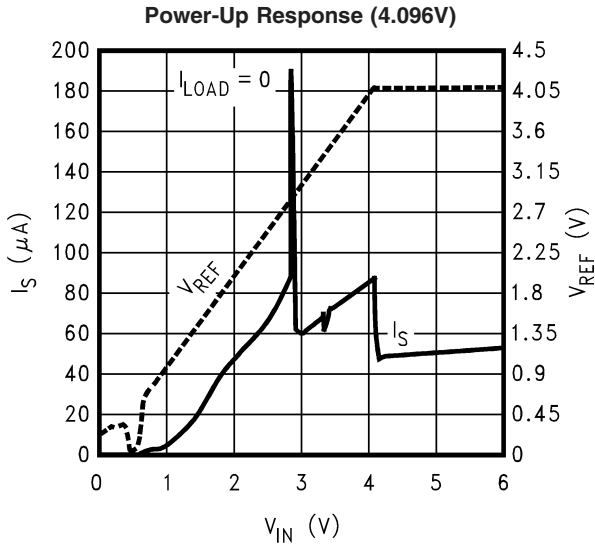

10104634

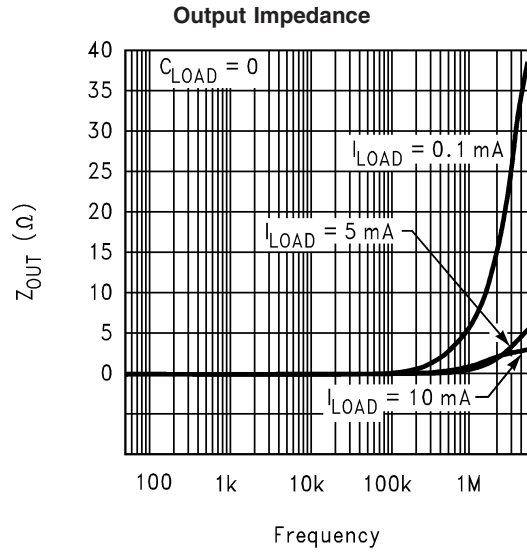

10104623

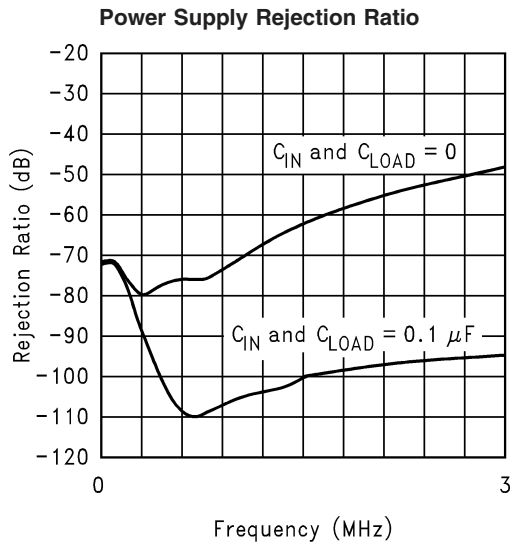

10104622

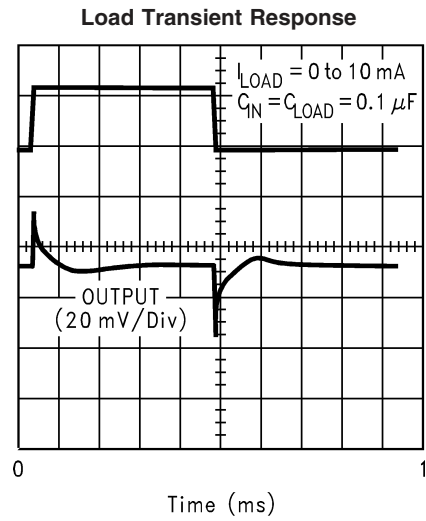

10104625

LM4130 Typical Performance Characteristics $T_A = 25^\circ\text{C}$, No Load, $V_{IN} = 5.0\text{V}$, unless otherwise noted. (Continued)

Line Transient Response

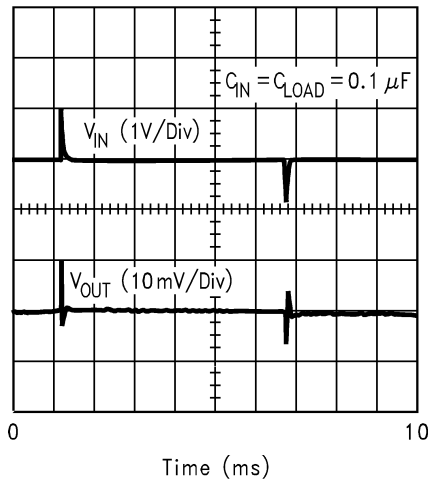

10104626

0.1Hz to 10 Hz Noise ($V_{REF} = 2.5\text{V}$)

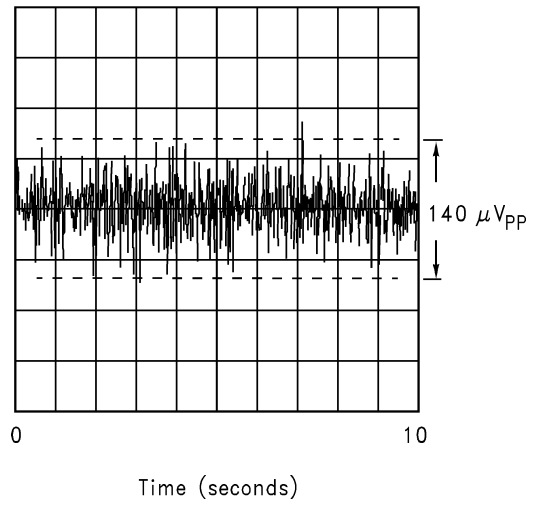

10104627

Output Noise Spectra

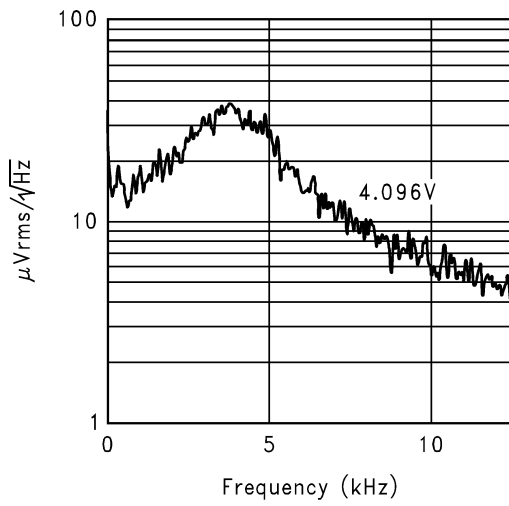

10104643

Pin Functions

V_{REF} (Pin 5): Reference Output. The output of the LM4130 can source up to 20 mA. It is stable with output capacitor ranges from 0 to 2.2 μ F.

V_{IN} (Pin 4): Positive Supply. Bypassing with a 0.1 μ F capacitor is recommended if the output loading changes or input is noisy.

Ground (Pin 2): Negative Supply or Ground Connection.

NC (Pins 1, 3): No Connection (internally terminated). These pins must be left unconnected.

Application Information

OUTPUT CAPACITOR

The LM4130 is designed to operate with or without an output capacitor and is stable with capacitive loads of up to 2.2 μ F.

Connecting a capacitor between the output and ground will significantly improve the load transient response when switching from a light load to a heavy load. However, the output capacitor should not be made arbitrarily large because it will effect the turn-on time as well as line and load transients.

INPUT CAPACITOR

A small 0.1 μ F capacitor on the input significantly improves stability under a wide range of load conditions. With an input bypass capacitor, the LM4130 will drive any combination of resistance and capacitance up to $V_{REF}/20\text{mA}$ and 2.2 μ F respectively.

Noise on the power-supply input can effect the output noise, but it can be reduced by using an optional bypass capacitor between the input pin and the ground.

PRINTED CIRCUIT BOARD LAYOUT CONSIDERATION

References in SOT packages are generally less prone to assembly stress than devices in Small Outline (SOIC) package.

To minimize the mechanical stress due to PC board mounting that can cause the output voltage to shift from its initial value, mount the reference on a low flex area of the PC board, such as near the edge or a corner.

Physical Dimensions inches (millimeters)

unless otherwise noted

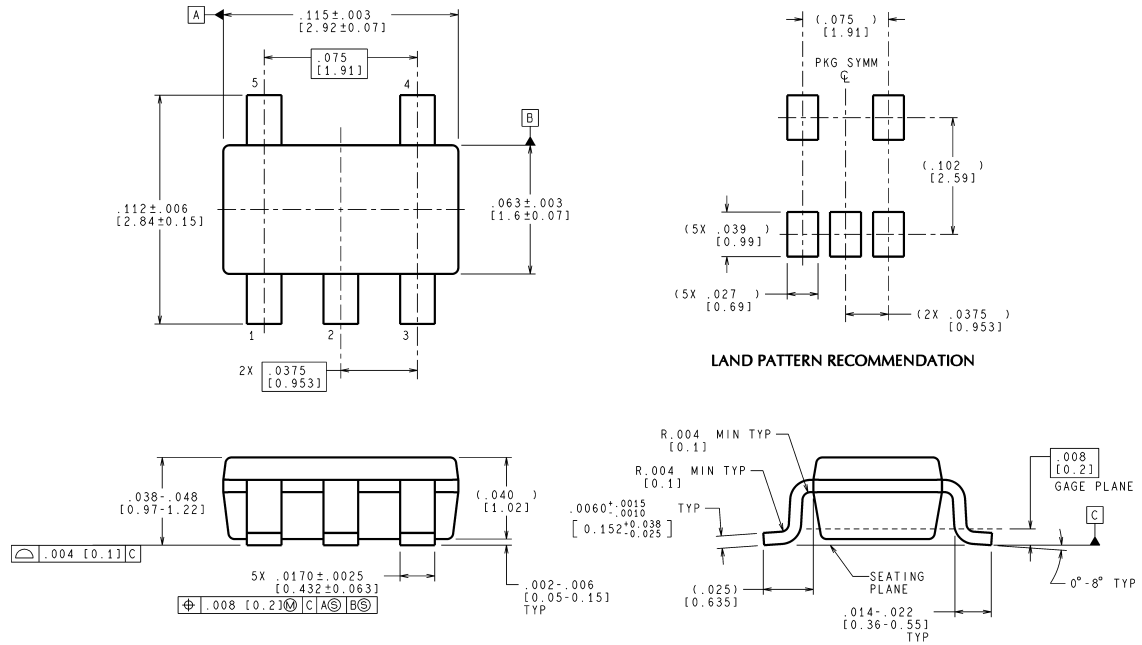

MF05A (Rev B)

LIFE SUPPORT POLICY

NATIONAL'S PRODUCTS ARE NOT AUTHORIZED FOR USE AS CRITICAL COMPONENTS IN LIFE SUPPORT DEVICES OR SYSTEMS WITHOUT THE EXPRESS WRITTEN APPROVAL OF THE PRESIDENT AND GENERAL COUNSEL OF NATIONAL SEMICONDUCTOR CORPORATION. As used herein:

1. Life support devices or systems are devices or systems which, (a) are intended for surgical implant into the body, or (b) support or sustain life, and whose failure to perform when properly used in accordance with instructions for use provided in the labeling, can be reasonably expected to result in a significant injury to the user.
2. A critical component is any component of a life support device or system whose failure to perform can be reasonably expected to cause the failure of the life support device or system, or to affect its safety or effectiveness.



National Semiconductor
Americas Customer
Support Center
Email: new.feedback@nsc.com
Tel: 1-800-272-9959

National Semiconductor
Europe Customer Support Center
Fax: +49 (0) 180-530 85 86
Email: europe.support@nsc.com
Deutsch Tel: +49 (0) 69 9508 6208
English Tel: +44 (0) 870 24 0 2171
Français Tel: +33 (0) 1 41 91 8790

National Semiconductor
Asia Pacific Customer
Support Center
Email: ap.support@nsc.com

National Semiconductor
Japan Customer Support Center
Fax: 81-3-5639-7507
Email: jpn.feedback@nsc.com
Tel: 81-3-5639-7560

www.national.com