

LM747 Dual Operational Amplifier

General Description

The LM747 is a general purpose dual operational amplifier. The two amplifiers share a common bias network and power supply leads. Otherwise, their operation is completely independent.

Additional features of the LM747 are: no latch-up when input common mode range is exceeded, freedom from oscillations, and package flexibility.

The LM747C/LM747E is identical to the LM747/LM747A except that the LM747C/LM747E has its specifications guaranteed over the temperature range from 0°C to +70°C instead of -55°C to +125°C.

Features

- No frequency compensation required
- Short-circuit protection
- Wide common-mode and differential voltage ranges
- Low power consumption
- No latch-up
- Balanced offset null

Connection Diagrams

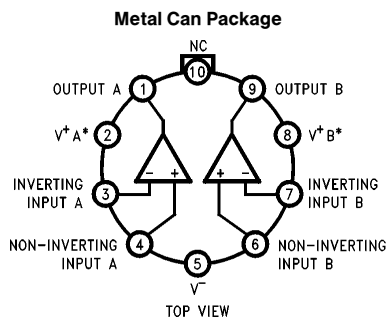

TL/H/11479-4

Order Number LM747H
See NS Package Number H10C

*V⁺A and V⁺B are internally connected.

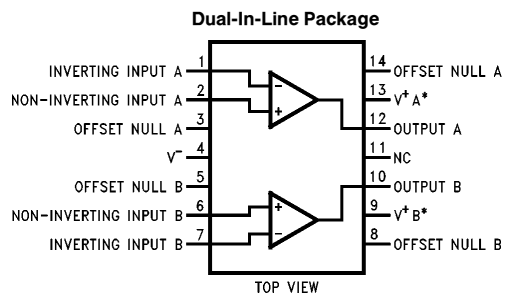

TL/H/11479-5

Order Number LM747CN or LM747EN
See NS Package Number N14A

Absolute Maximum Ratings

If Military/Aerospace specified devices are required, please contact the National Semiconductor Sales Office/Distributors for availability and specifications.

Supply Voltage	
LM747/LM747A	±22V
LM747C/LM747E	±18V
Power Dissipation (Note 1)	800 mW
Differential Input Voltage	±30V

Input Voltage (Note 2)	±15V
Output Short-Circuit Duration	Indefinite
Operating Temperature Range	
LM747/LM747A	-55°C to +125°C
LM747C/LM747E	0°C to +70°C
Storage Temperature Range	-65°C to +150°C
Lead Temperature (Soldering, 10 sec.)	300°C

Electrical Characteristics (Note 3)

Parameter	Conditions	LM747A/LM747E			LM747			LM747C			Units
		Min	Typ	Max	Min	Typ	Max	Min	Typ	Max	
Input Offset Voltage	$T_A = 25^\circ\text{C}$ $R_S \leq 10\text{ k}\Omega$ $R_S \leq 50\Omega$		0.8	3.0	1.0	5.0		2.0	6.0		mV
	$R_S \leq 50\Omega$ $R_S \leq 10\text{ k}\Omega$			4.0		6.0			7.5		mV
Average Input Offset Voltage Drift				15							$\mu\text{V}/^\circ\text{C}$
Input Offset Voltage Adjustment Range	$T_A = 25^\circ\text{C}$, $V_S = \pm 20\text{V}$	±10			±15			±15			mV
Input Offset Current	$T_A = 25^\circ\text{C}$		3.0	30	20	200		20	200		nA
				70	85	500			300		
Average Input Offset Current Drift				0.5							nA/ $^\circ\text{C}$
Input Bias Current	$T_A = 25^\circ\text{C}$ $T_{\text{AMIN}} \leq T_A \leq T_{\text{AMAX}}$		30	80	80	500		80	500		nA
				0.210		1.5			0.8		μA
Input Resistance	$T_A = 25^\circ\text{C}$, $V_S = \pm 20\text{V}$	1.0	6.0		0.3	2.0		0.3	2.0		M Ω
	$V_S = \pm 20\text{V}$	0.5									
Input Voltage Range	$T_A = 25^\circ\text{C}$							±12	±13		V
		±12	±13		±12	±13					
Large Signal Voltage Gain	$T_A = 25^\circ\text{C}$, $R_L \geq 2\text{ k}\Omega$ $V_S = \pm 20\text{V}$, $V_O = \pm 15\text{V}$	50									V/mV
	$V_S = \pm 15\text{V}$, $V_O = \pm 10\text{V}$ $R_L \geq 2\text{ k}\Omega$				50	200		20	200		V/mV
	$V_S = \pm 20\text{V}$, $V_O = \pm 15\text{V}$	32									V/mV
	$V_S = \pm 15\text{V}$, $V_O = \pm 10\text{V}$				25			15			V/mV
	$V_S = \pm 5\text{V}$, $V_O = \pm 2\text{V}$	10									V/mV
Output Voltage Swing	$V_S = \pm 20\text{V}$ $R_L \geq 10\text{ k}\Omega$ $R_L \geq 2\text{ k}\Omega$	±16									V
	$V_S = \pm 15\text{V}$ $R_L \geq 10\text{ k}\Omega$ $R_L \geq 2\text{ k}\Omega$				±12	±14		±12	±14		V
		±10	±13		±10	±13		±10	±13		
Output Short Circuit Current	$T_A = 25^\circ\text{C}$	10	25	35	25			25			mA
Common-Mode Rejection Ratio	$R_S \leq 10\text{ k}\Omega$, $V_{\text{CM}} = \pm 12\text{V}$				70	90		70	90		dB
	$R_S \leq 50\text{ k}\Omega$, $V_{\text{CM}} = \pm 12\text{V}$	80	95								

Electrical Characteristics (Note 3) (Continued)

Parameter	Conditions	LM747A/LM747E			LM747			LM747C			Units
		Min	Typ	Max	Min	Typ	Max	Min	Typ	Max	
Supply Voltage Rejection Ratio	$V_S = \pm 20V$ to $V_S = \pm 5V$ $R_S \leq 50\Omega$ $R_S \leq 10\text{ k}\Omega$	86	96		77	96		77	96		dB
Transient Response Rise Time Overshoot	$T_A = 25^\circ\text{C}$, Unity Gain		0.25 6.0	0.8 20		0.3 5			0.3 5		μs %
Bandwidth (Note 4)	$T_A = 25^\circ\text{C}$	0.437	1.5								MHz
Slew Rate	$T_A = 25^\circ\text{C}$, Unity Gain	0.3	0.7		0.5			0.5			$\text{V}/\mu\text{s}$
Supply Current/Amp	$T_A = 25^\circ\text{C}$			2.5	1.7	2.8		1.7	2.8		mA
Power Consumption/Amp	$T_A = 25^\circ\text{C}$ $V_S = \pm 20V$ $V_S = \pm 15V$		80	150		50	85		50	85	mW
LM747A	$V_S = \pm 20V$ $T_A = T_{A\text{MIN}}$ $T_A = T_{A\text{MAX}}$			165 135							mW
LM747E	$V_S = \pm 20V$ $T_A = T_{A\text{MIN}}$ $T_A = T_{A\text{MAX}}$			150 150 150							mW
LM747	$V_S = \pm 15V$ $T_A = T_{A\text{MIN}}$ $T_A = T_{A\text{MAX}}$				60	100		45	75		mW

Note 1: The maximum junction temperature of the LM747C/LM747E is 100°C . For operating at elevated temperatures, devices in the TO-5 package must be derated based on a thermal resistance of $150^\circ\text{C}/\text{W}$, junction to ambient, or $45^\circ\text{C}/\text{W}$, junction to case. The thermal resistance of the dual-in-line package is $100^\circ\text{C}/\text{W}$, junction to ambient.

Note 2: For supply voltages less than $\pm 15V$, the absolute maximum input voltage is equal to the supply voltage.

Note 3: These specifications apply for $\pm 5V \leq V_S \leq \pm 20V$ and $-55^\circ\text{C} \leq T_A \leq 125^\circ\text{C}$ for the LM747A and $0^\circ\text{C} \leq T_A \leq 70^\circ\text{C}$ for the LM747E unless otherwise specified. The LM747 and LM747C are specified for $V_S = \pm 15V$ and $-55^\circ\text{C} \leq T_A \leq 125^\circ\text{C}$ and $0^\circ\text{C} \leq T_A \leq 70^\circ\text{C}$, respectively, unless otherwise specified.

Note 4: Calculated value from: $0.35/\text{Rise Time}$ (μs).

Schematic Diagram (Each Amplifier)

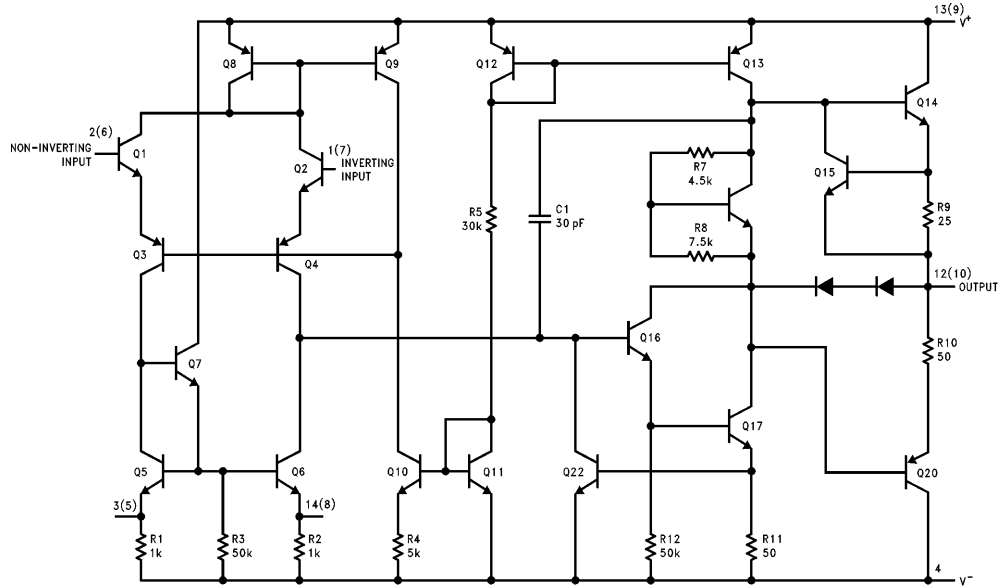

Note: Numbers in parentheses are pin numbers for amplifier B, DIP only.

Typical Performance Characteristics

Input Bias and Offset Currents vs Ambient Temperature

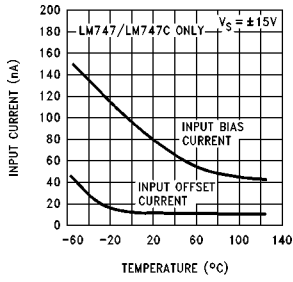

DC Parameters vs Supply Voltage

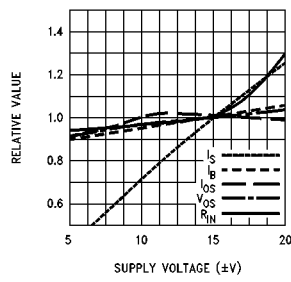

Common Mode Rejection Ratio vs Frequency

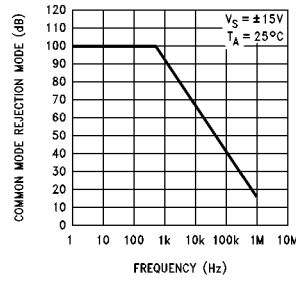

Output Voltage Swing vs Frequency

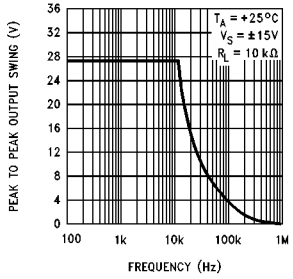

Output Voltage Swing vs Load Resistance

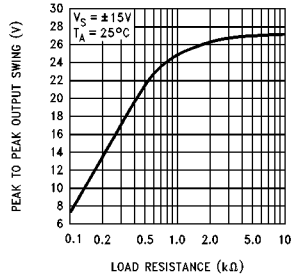

Output Swing and Input Range vs Supply Voltage

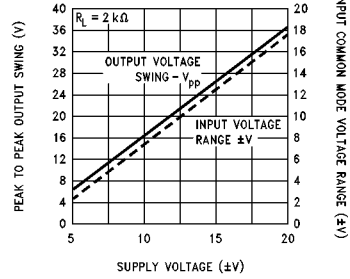

Normalized DC Parameters vs Ambient Temperature

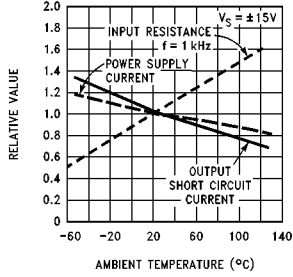

Transient Response

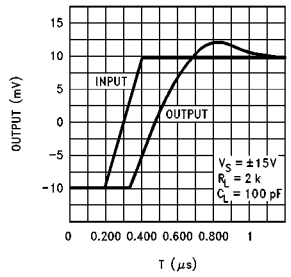

Frequency Characteristics vs Ambient Temperature

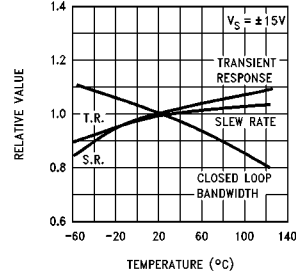

Frequency Characteristics vs Supply Voltage

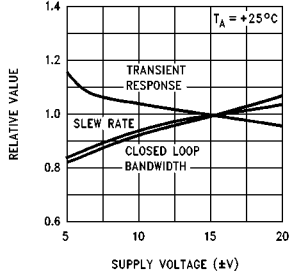

Output Resistance vs Frequency

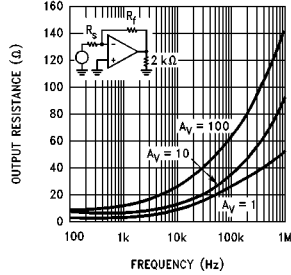

Open Loop Transfer Characteristics vs Frequency

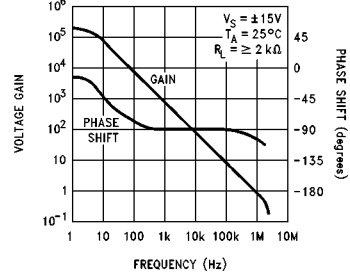

TL/H/11479-2

Typical Performance Characteristics (Continued)

Input Resistance and Input Capacitance vs Frequency

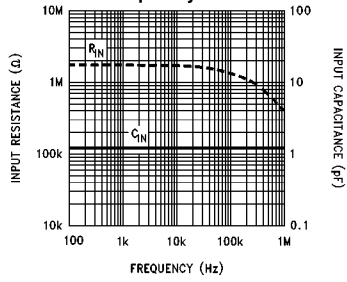

Broadband Noise for Various Bandwidths

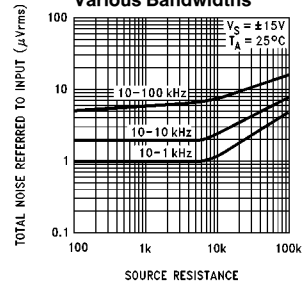

Input Noise Voltage and Current vs Frequency

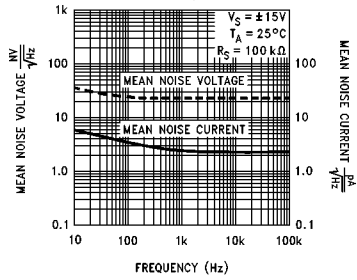

Voltage Follower Large Signal Pulse Response

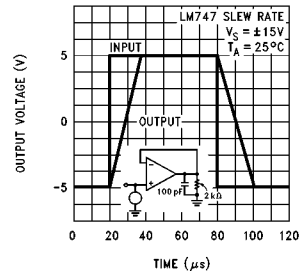

TL/H/11479-3

Physical Dimensions inches (millimeters)

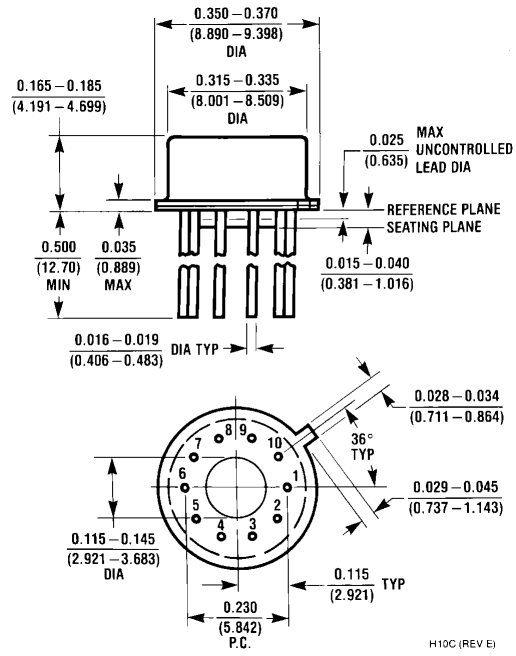

H10C (REV E)

Metal Can Package (H)
Order Number LM747H
NS Package Number H10C

Physical Dimensions inches (millimeters) (Continued)

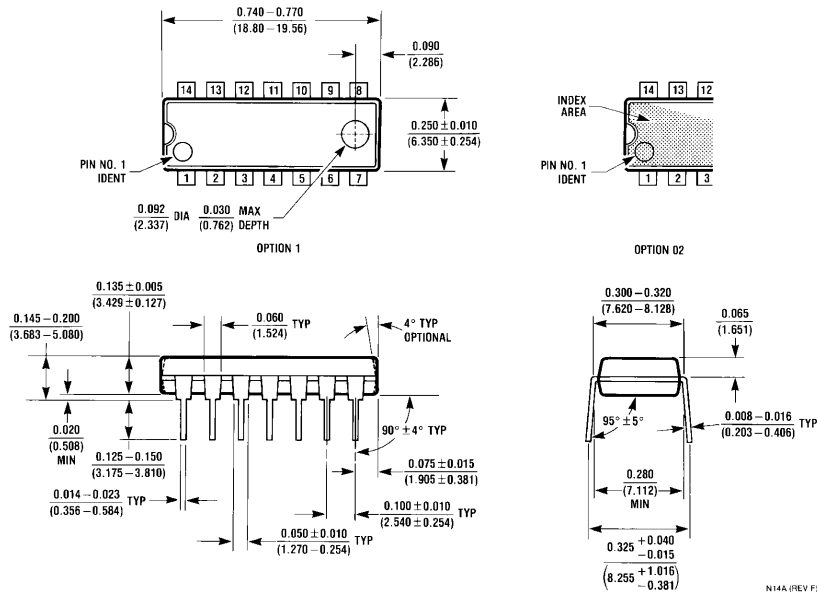

Dual-In-Line Package (N)
Order Number LM747CN or LM747EN
NS Package Number N14A

LIFE SUPPORT POLICY

NATIONAL'S PRODUCTS ARE NOT AUTHORIZED FOR USE AS CRITICAL COMPONENTS IN LIFE SUPPORT DEVICES OR SYSTEMS WITHOUT THE EXPRESS WRITTEN APPROVAL OF THE PRESIDENT OF NATIONAL SEMICONDUCTOR CORPORATION. As used herein:

1. Life support devices or systems are devices or systems which, (a) are intended for surgical implant into the body, or (b) support or sustain life, and whose failure to perform, when properly used in accordance with instructions for use provided in the labeling, can be reasonably expected to result in a significant injury to the user.
2. A critical component is any component of a life support device or system whose failure to perform can be reasonably expected to cause the failure of the life support device or system, or to affect its safety or effectiveness.



National Semiconductor Corporation
 1111 West Bardin Road
 Arlington, TX 76017
 Tel: 1(800) 272-9959
 Fax: 1(800) 737-7018

National Semiconductor Europe
 Fax: (+49) 0-180-530 85 86
 Email: cnjwge@tevm2.nsc.com
 Deutsch Tel: (+49) 0-180-530 85 85
 English Tel: (+49) 0-180-532 78 32
 Français Tel: (+49) 0-180-532 93 58
 Italiano Tel: (+49) 0-180-534 16 80

National Semiconductor Hong Kong Ltd.
 19th Floor, Straight Block,
 Ocean Centre, 5 Canton Rd.
 Tsimshatsui, Kowloon
 Hong Kong
 Tel: (852) 2737-1600
 Fax: (852) 2736-9960

National Semiconductor Japan Ltd.
 Tel: 81-043-299-2309
 Fax: 81-043-299-2408

National does not assume any responsibility for use of any circuitry described, no circuit patent licenses are implied and National reserves the right at any time without notice to change said circuitry and specifications.