

LM748 Operational Amplifier

General Description

The LM748 is a general purpose operational amplifier with external frequency compensation.

The unity-gain compensation specified makes the circuit stable for all feedback configurations, even with capacitive loads. It is possible to optimize compensation for best high frequency performance at any gain. As a comparator, the output can be clamped at any desired level to make it compatible with logic circuits.

The LM748C is specified for operation over the 0°C to +70°C temperature range.

Features

- Frequency compensation with a single 30 pF capacitor
- Operation from $\pm 5V$ to $\pm 20V$
- Continuous short-circuit protection
- Operation as a comparator with differential inputs as high as $\pm 30V$
- No latch-up when common mode range is exceeded
- Same pin configuration as the LM101

Connection Diagram

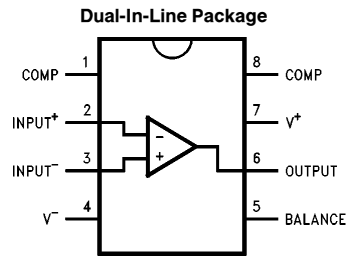

TL/H/11478-2

Top View
Order Number LM748CN
See NS Package Number N08B

Absolute Maximum Ratings

If Military/Aerospace specified devices are required, please contact the National Semiconductor Sales Office/Distributors for availability and specifications.

Supply Voltage	±22V
Power Dissipation (Note 1)	500 mW
Differential Input Voltage	±30V

Input Voltage (Note 2)	±15V
Output Short-Circuit Duration (Note 3)	
Operating Temperature Range: LM748C	0°C to +70°C
Storage Temperature Range	-65°C to +150°C
Lead Temperature (Soldering, 10 sec.)	+300°C

Electrical Characteristics (Note 4)

Parameter	Conditions	Min	Typ	Max	Units
Input Offset Voltage	$T_A = 25^\circ\text{C}, R_S \leq 10\text{ k}\Omega$		1.0	5.0	mV
Input Offset Current	$T_A = 25^\circ\text{C}$		40	200	nA
Input Bias Current	$T_A = 25^\circ\text{C}$		120	500	nA
Input Resistance	$T_A = 25^\circ\text{C}$	300	800		k Ω
Supply Current	$T_A = 25^\circ\text{C}, V_S = \pm 15\text{V}$		1.8	2.8	mA
Large Signal Voltage Gain	$T_A = 25^\circ\text{C}, V_S = \pm 15\text{V}$ $V_{OUT} = \pm 10\text{V}, R_L \geq 2\text{ k}\Omega$	50	160		V/mV
Input Offset Voltage	$R_S \leq 10\text{ k}\Omega$			6.0	mV
Average Temperature Coefficient of Input Offset Voltage	$R_S \leq 50\Omega$		3.0		$\mu\text{V}/^\circ\text{C}$
	$R_S \leq 10\text{ k}\Omega$		6.0		$\mu\text{V}/^\circ\text{C}$
Input Offset Current	$T_A = 0^\circ\text{C to } +70^\circ\text{C}$			300	nA
	$T_A = -55^\circ\text{C to } +125^\circ\text{C}$			500	nA
Input Bias Current	$T_A = 0^\circ\text{C to } +70^\circ\text{C}$			0.8	μA
	$T_A = -55^\circ\text{C to } +125^\circ\text{C}$			1.5	μA
Supply Current	$T_A = +125^\circ\text{C}, V_S = \pm 15\text{V}$		1.2	2.25	mA
	$T_A = -55^\circ\text{C to } +125^\circ\text{C}$		1.9	3.3	mA
Large Signal Voltage Gain	$V_S = \pm 15\text{V}, V_{OUT} = \pm 10\text{V}$ $R_L \geq 2\text{ k}\Omega$	25			V/mV
Output Voltage Swing	$V_S = \pm 15\text{V}, R_L = 10\text{ k}\Omega$	±12	±14		V
	$V_S = \pm 15\text{V}, R_L = 2\text{ k}\Omega$	±10	±13		V
Input Voltage Range	$V_S = \pm 15\text{V}$	±12			V
Common-Mode Rejection Ratio	$R_S \leq 10\text{ k}\Omega$	70	90		dB
Supply Voltage Rejection Ratio	$R_S \leq 10\text{ k}\Omega$	77	90		dB

Note 1: For operating at elevated temperatures, the device must be derated based on a maximum junction to case thermal resistance of 45°C per watt, or 150°C per watt junction to ambient. (See Curves).

Note 2: For supply voltages less than ±15V, the absolute maximum input voltage is equal to the supply voltage.

Note 3: Continuous short circuit is allowed for case temperatures to +125°C and ambient temperatures to +70°C.

Note 4: These specifications apply for $\pm 5\text{V} \leq V_S \leq +15\text{V}$ and $0^\circ\text{C} \leq T_A \leq +70^\circ\text{C}$, unless otherwise specified.

Typical Applications

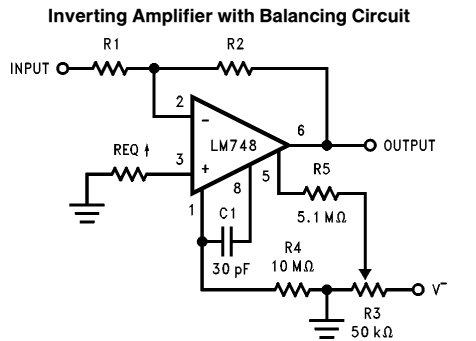

†May be zero or equal to parallel combination of R1 and R2 for minimum offset.

TL/H/11478-3

Voltage Comparator for Driving DTL or TTL Integrated Circuits

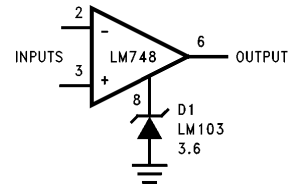

TL/H/11478-4

Voltage Comparator for Driving RTL Logic or High Current Driver

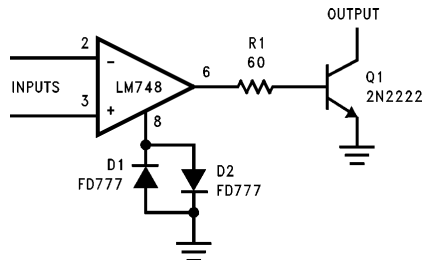

TL/H/11478-5

Guaranteed Performance Characteristics (Note 4)

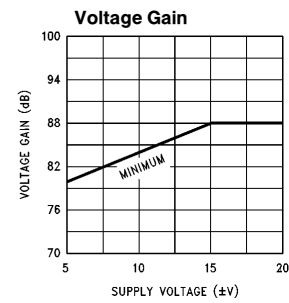
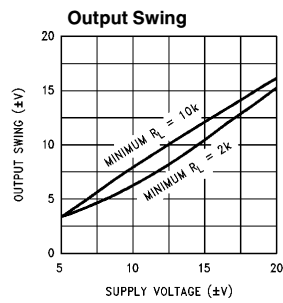
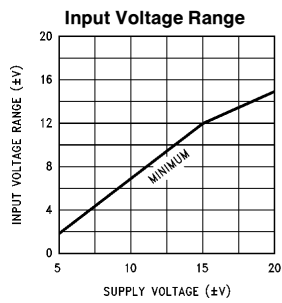

TL/H/11478-6

Typical Performance Characteristics

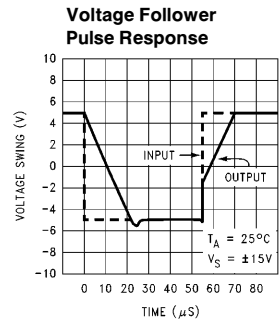
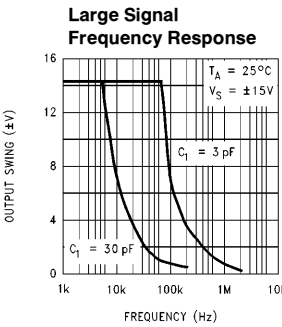
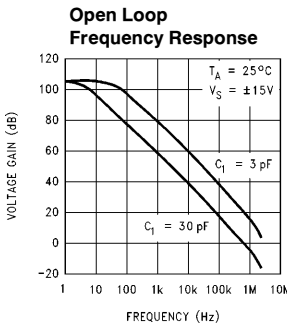
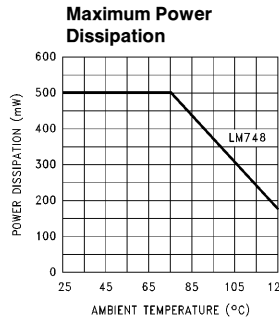
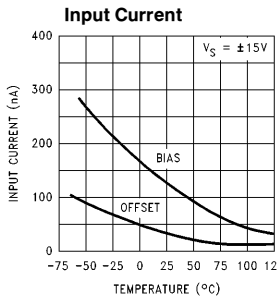
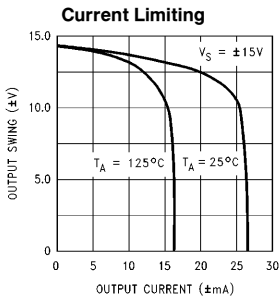
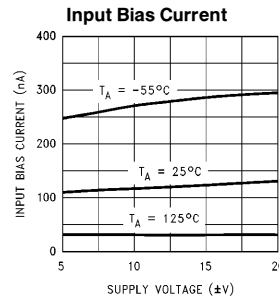
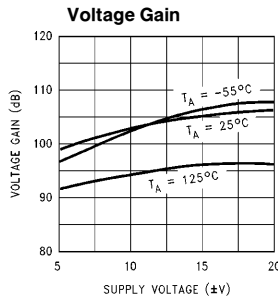
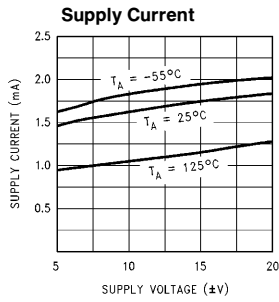

TL/H/11478-7



Physical Dimensions inches (millimeters)

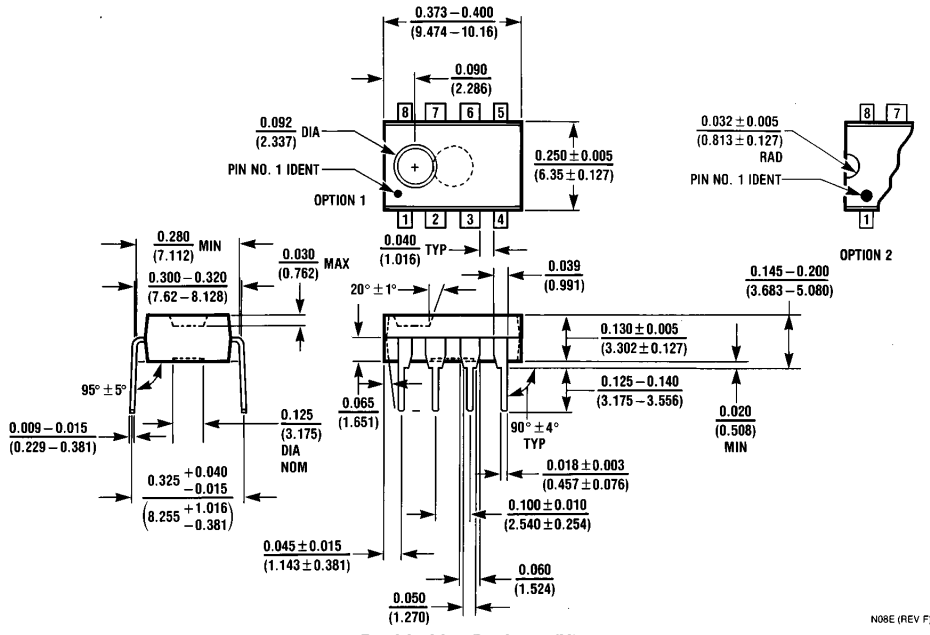

**Dual-In-Line Package (N)
Order Number LM748CN
NS Package Number N08E**

N08E (REV F)

LIFE SUPPORT POLICY

NATIONAL'S PRODUCTS ARE NOT AUTHORIZED FOR USE AS CRITICAL COMPONENTS IN LIFE SUPPORT DEVICES OR SYSTEMS WITHOUT THE EXPRESS WRITTEN APPROVAL OF THE PRESIDENT OF NATIONAL SEMICONDUCTOR CORPORATION. As used herein:

1. Life support devices or systems are devices or systems which, (a) are intended for surgical implant into the body, or (b) support or sustain life, and whose failure to perform, when properly used in accordance with instructions for use provided in the labeling, can be reasonably expected to result in a significant injury to the user.
2. A critical component is any component of a life support device or system whose failure to perform can be reasonably expected to cause the failure of the life support device or system, or to affect its safety or effectiveness.

 <p>National Semiconductor Corporation 1111 West Bardin Road Arlington, TX 76017 Tel: 1(800) 272-9959 Fax: 1(800) 737-7018</p>	<p>National Semiconductor Europe Fax: (+49) 0-180-530 85 86 Email: cnjwge@tevm2.nsc.com Deutsch Tel: (+49) 0-180-530 85 85 English Tel: (+49) 0-180-532 78 32 Français Tel: (+49) 0-180-532 93 58 Italiano Tel: (+49) 0-180-534 16 80</p>	<p>National Semiconductor Hong Kong Ltd. 19th Floor, Straight Block, Ocean Centre, 5 Canton Rd. Tsimshatsui, Kowloon Hong Kong Tel: (852) 2737-1600 Fax: (852) 2736-9960</p>	<p>National Semiconductor Japan Ltd. Tel: 81-043-299-2309 Fax: 81-043-299-2408</p>
--	--	---	---

National does not assume any responsibility for use of any circuitry described, no circuit patent licenses are implied and National reserves the right at any time without notice to change said circuitry and specifications.