

# LM837

## Low Noise Quad Operational Amplifier

### General Description

The LM837 is a quad operational amplifier designed for low noise, high speed and wide bandwidth performance. It has a new type of output stage which can drive a 600Ω load, making it ideal for almost all digital audio, graphic equalizer, preamplifiers, and professional audio applications. Its high performance characteristics also make it suitable for instrumentation applications where low noise is the key consideration.

The LM837 is internally compensated for unity gain operation. It is pin compatible with most other standard quad op amps and can therefore be used to upgrade existing systems with little or no change.

### Features

- High slew rate 10 V/μs (typ); 8 V/μs (min)
- Wide gain bandwidth product 25 MHz (typ); 15 MHz (min)
- Power bandwidth 200 kHz (typ)
- High output current ±40 mA
- Excellent output drive performance >600Ω
- Low input noise voltage 4.5 nV/√Hz
- Low total harmonic distortion 0.0015%
- Low offset voltage 0.3 mV

### Schematic and Connection Diagrams

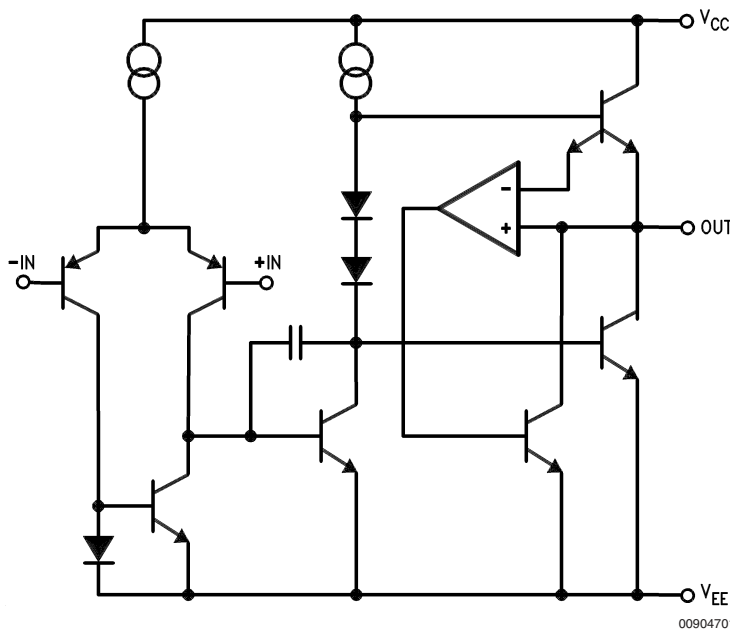

Dual-In-Line Package

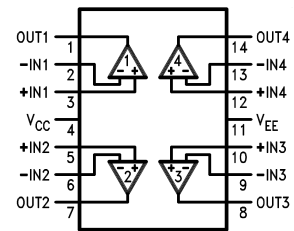

Top View  
Order Number LM837M,  
LM837MX or LM837N  
See NS Package Number  
M14A or N14A

**Absolute Maximum Ratings** (Note 1)

If Military/Aerospace specified devices are required, please contact the National Semiconductor Sales Office/Distributors for availability and specifications.

Supply Voltage, $V_{CC}/V_{EE}$	$\pm 18V$
Differential Input Voltage, $V_{ID}$ (Note 2)	$\pm 30V$
Common Mode Input Voltage, $V_{IC}$ (Note 2)	$\pm 15V$
Power Dissipation, $P_D$ (Note 3)	1.2W (N) 830 mW (M)
Operating Temperature Range, $T_{OPR}$	$-40^{\circ}C$ to $+85^{\circ}C$

Storage Temperature Range,  $T_{STG}$   $-60^{\circ}C$  to  $+150^{\circ}C$

## Soldering Information

Dual-In-Line Package	
Soldering (10 seconds)	$260^{\circ}C$
Small Outline Package	
Vapor Phase (60 seconds)	$215^{\circ}C$
Infrared (15 seconds)	$220^{\circ}C$

ESD rating to be determined.

See AN-450 "Surface Mounting Methods and Their Effect on Product Reliability" for other methods of soldering surface mount devices.

**DC Electrical Characteristics**

$T_A = 25^{\circ}C$ ,  $V_S = \pm 15V$

Symbol	Parameter	Condition	Min	Typ	Max	Units
$V_{OS}$	Input Offset Voltage	$R_S = 50\Omega$		0.3	5	mV
$I_{OS}$	Input Offset Current			10	200	nA
$I_B$	Input Bias Current			500	1000	nA
$A_V$	Large Signal Voltage Gain	$R_L = 2\text{ k}\Omega$ , $V_{OUT} = \pm 10V$	90	110		dB
$V_{OM}$	Output Voltage Swing	$R_L = 2\text{ k}\Omega$	$\pm 12$	$\pm 13.5$		V
		$R_L = 600\Omega$	$\pm 10$	$\pm 12.5$		V
$V_{CM}$	Common Mode Input Voltage		$\pm 12$	$\pm 14.0$		V
CMRR	Common Mode Rejection Ratio	$V_{IN} = \pm 12V$	80	100		dB
PSRR	Power Supply Rejection Ratio	$V_S = 15 \sim 5, -15 \sim -5$	80	100		dB
$I_S$	Power Supply Current	$R_L = \infty$ , Four Amps		10	15	mA

**AC Electrical Characteristics**

$T_A = 25^{\circ}C$ ,  $V_S = \pm 15V$

Symbol	Parameter	Condition	Min	Typ	Max	Units
SR	Slew Rate	$R_L = 600\Omega$	8	10		V/ $\mu s$
GBW	Gain Bandwidth Product	$f = 100\text{ kHz}$ , $R_L = 600\Omega$	15	25		MHz

**Design Electrical Characteristics**

$T_A = 25^{\circ}C$ ,  $V_S = \pm 15V$  (Note 4)

Symbol	Parameter	Condition	Min	Typ	Max	Units
PBW	Power Bandwidth	$V_O = 25\text{ V}_{P-P}$ , $R_L = 600\Omega$ , THD < 1%		200		kHz
$e_{n1}$	Equivalent Input Noise Voltage	JIS A, $R_S = 100\Omega$		0.5		$\mu V$
$e_{n2}$	Equivalent Input Noise Voltage	$f = 1\text{ kHz}$		4.5		nV/ $\sqrt{\text{Hz}}$
$i_n$	Equivalent Input Noise Current	$f = 1\text{ kHz}$		0.7		pA/ $\sqrt{\text{Hz}}$
THD	Total Harmonic Distortion	$A_V = 1$ , $V_{OUT} = 3\text{ V}_{rms}$ , $f = 20 \sim 20\text{ kHz}$ , $R_L = 600\Omega$		0.0015		%
$f_U$	Zero Cross Frequency	Open Loop		12		MHz
$\phi_m$	Phase Margin	Open Loop		45		deg
	Input-Referenced Crosstalk	$f = 20 \sim 20\text{ kHz}$		-120		dB
$\Delta V_{OS}/\Delta T$	Average TC of Input Offset Voltage			2		$\mu V/^{\circ}C$

## Design Electrical Characteristics (Continued)

**Note 1:** Absolute Maximum Ratings indicate limits beyond which damage to the device may occur. Operating Ratings indicate conditions for which the device is functional, but do not guarantee specific performance limits. Electrical Characteristics state DC and AC electrical specifications under particular test conditions which guarantee specific performance limits. This assumes that the device is within the Operating Ratings. Specifications are not guaranteed for parameters where no limit is given, however, the typical value is a good indication of device performance.

**Note 2:** Unless otherwise specified the absolute maximum input voltage is equal to the power supply voltage.

**Note 3:** For operation at ambient temperatures above 25°C, the device must be derated based on a 150°C maximum junction temperature and a thermal resistance, junction to ambient, as follows: LM837N, 90°C/W; LM837M, 150°C/W.

**Note 4:** The following parameters are not tested or guaranteed.

## Detailed Schematic

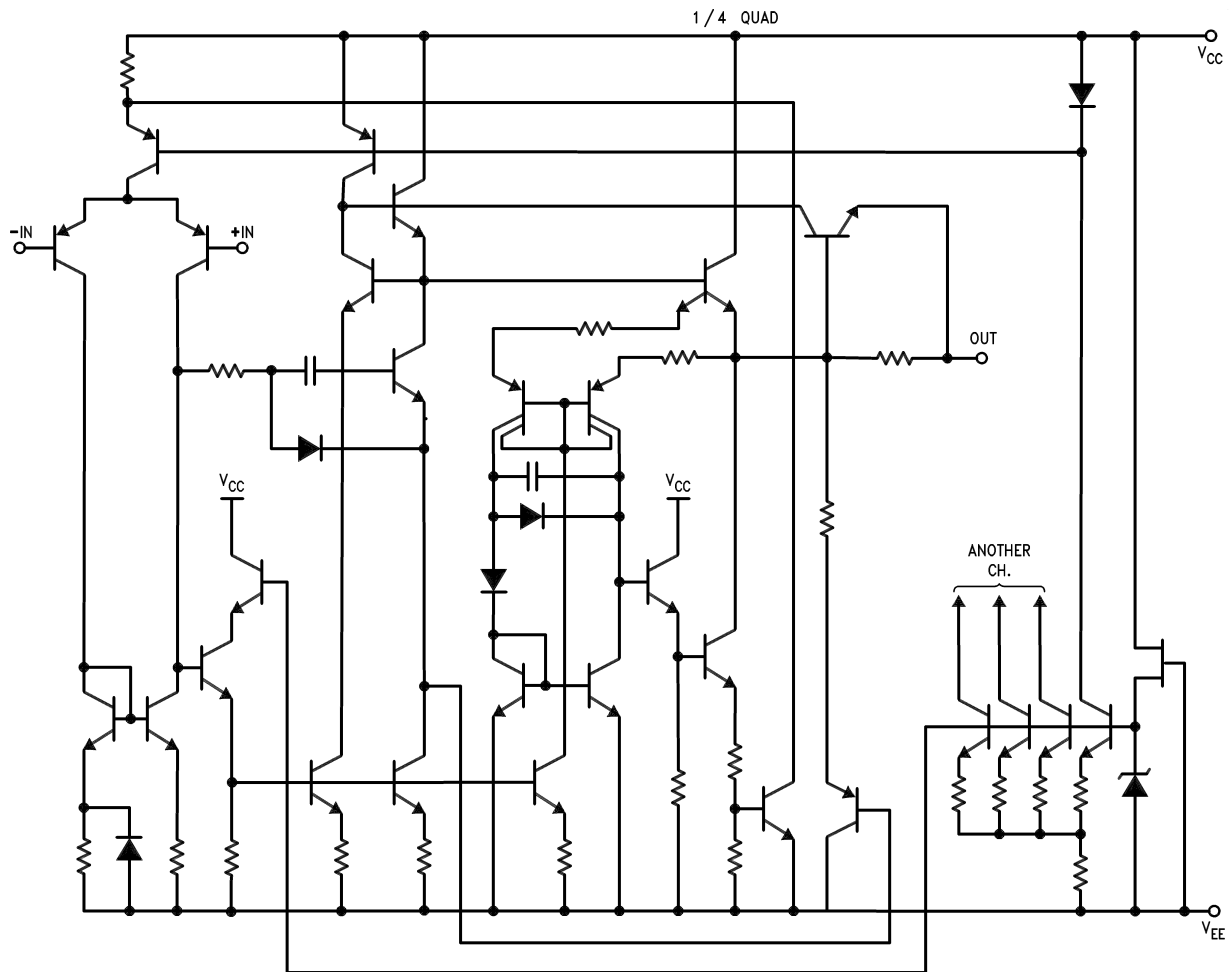

# Typical Performance Characteristics

**Maximum Power Dissipation vs Ambient Temperature**

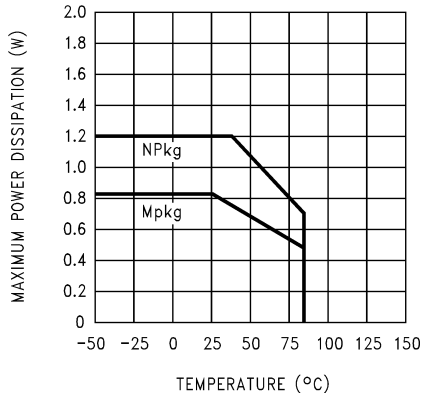

00904710

**Normalized Input Bias Current vs Supply Voltage**

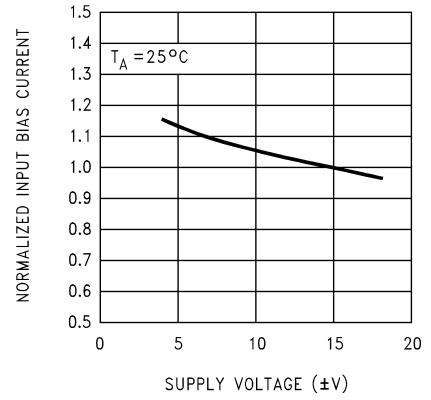

00904711

**Normalized Input Bias Current vs Ambient Temperature**

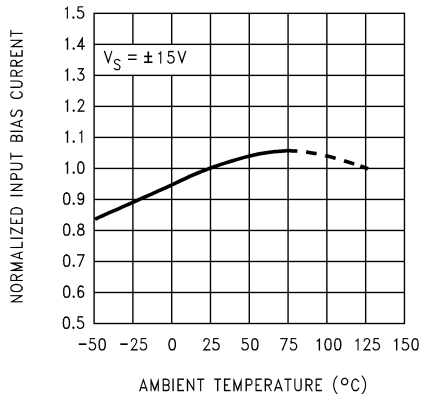

00904712

**Supply Current vs Supply Voltage**

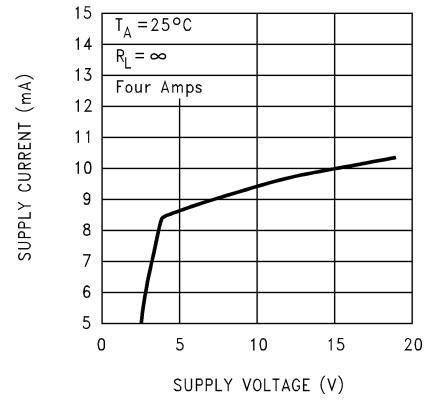

00904713

**Supply Current vs Ambient Temperature**

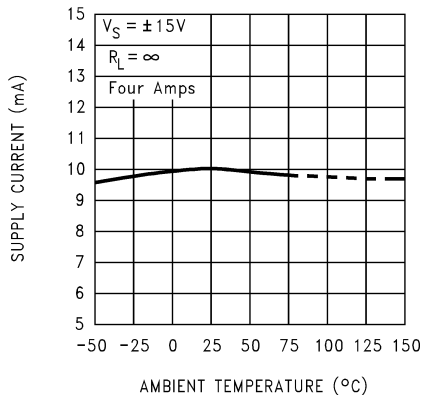

00904714

**Positive Current Limit**

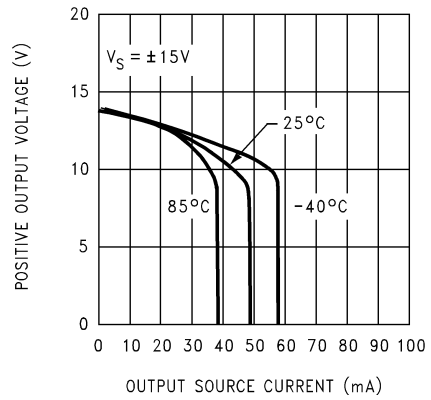

00904715

Typical Performance Characteristics (Continued)

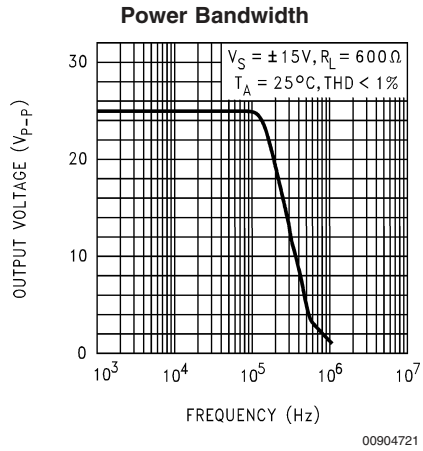
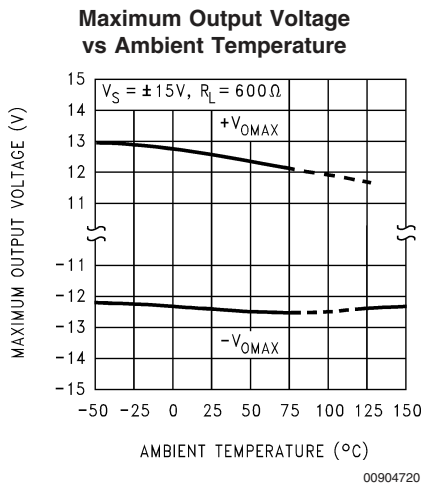
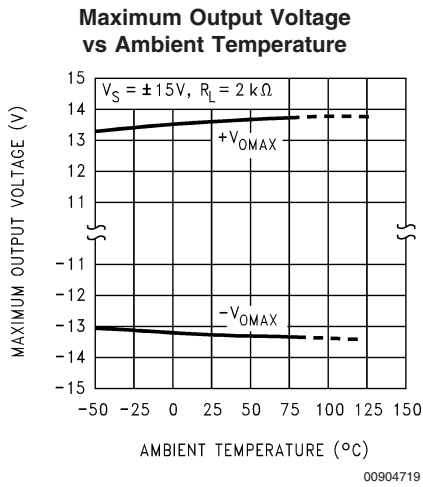
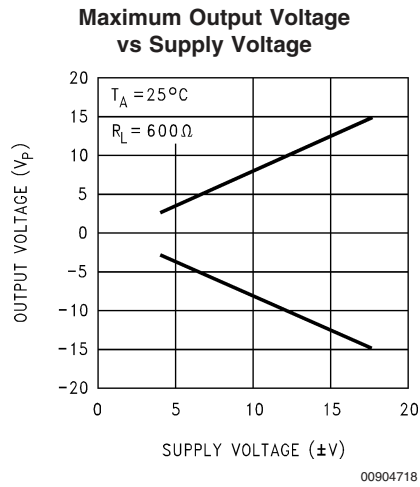
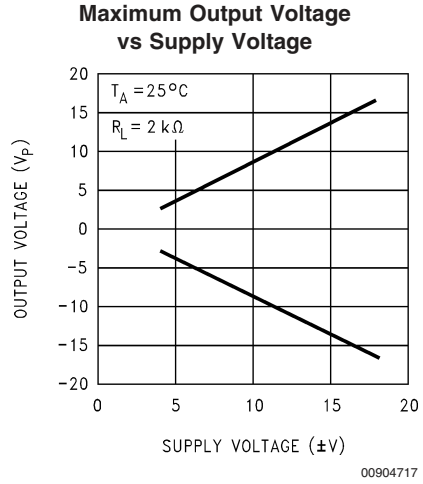
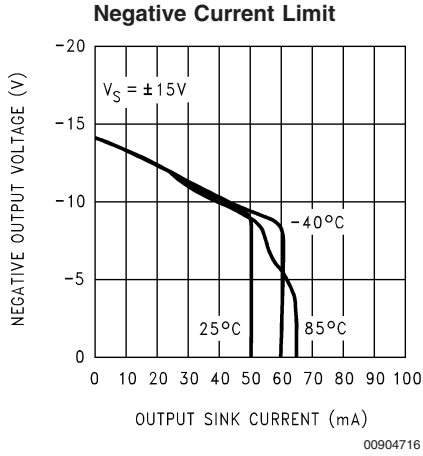

Typical Performance Characteristics (Continued)

Normalized Slew Rate & Gain Bandwidth vs Supply Voltage (f = 100 kHz)

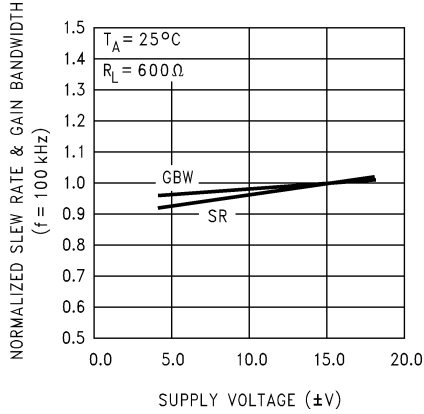

Normalized Slew Rate & Gain Bandwidth (f = 100 kHz) vs Ambient Temperature

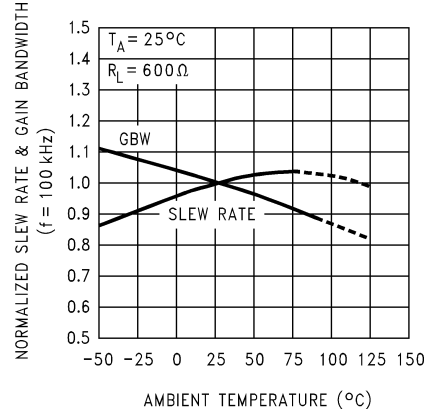

Voltage Gain vs Supply Voltage

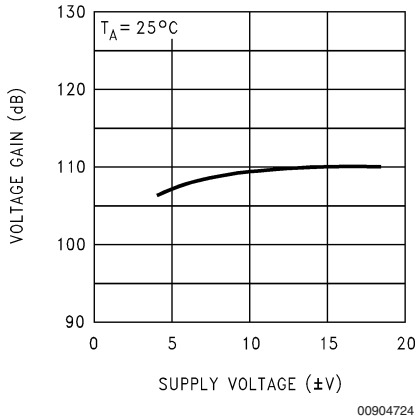

Voltage Gain vs Ambient Temperature

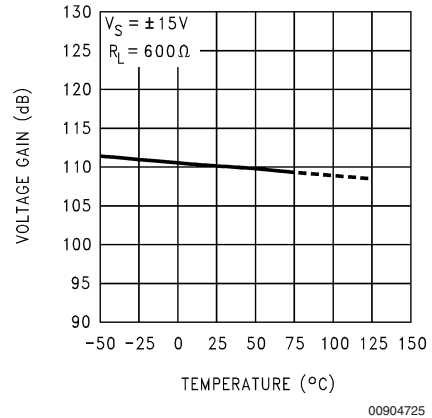

Power Supply Rejection vs Frequency

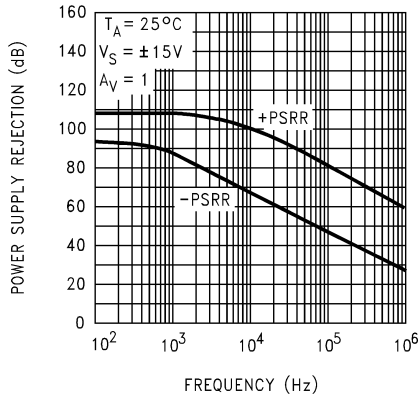

CMRR vs Frequency

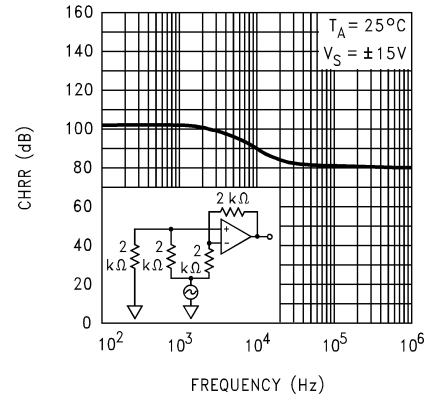

Typical Performance Characteristics (Continued)

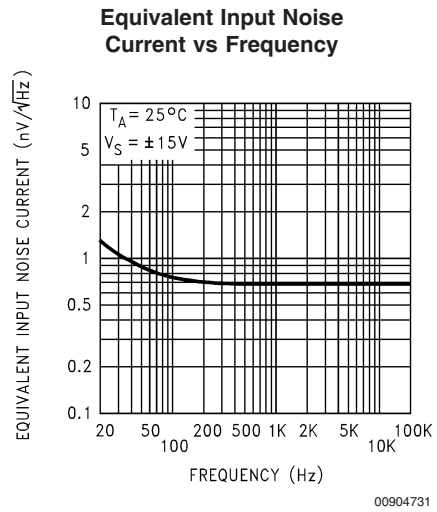
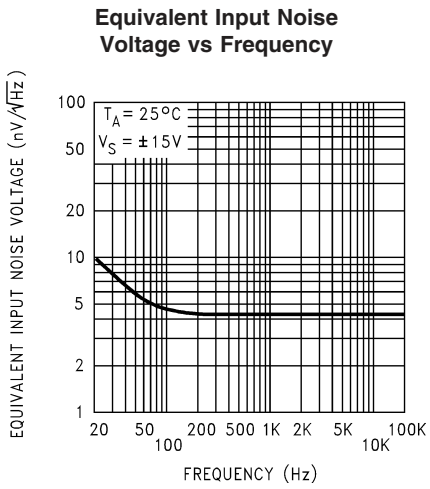
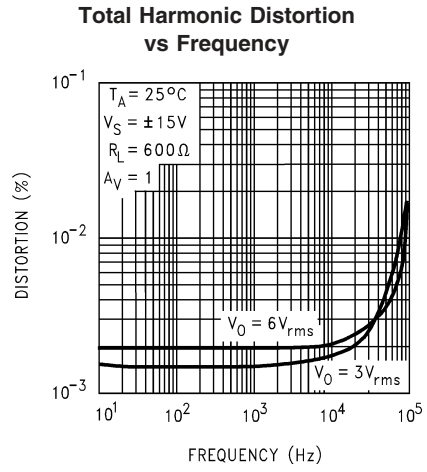
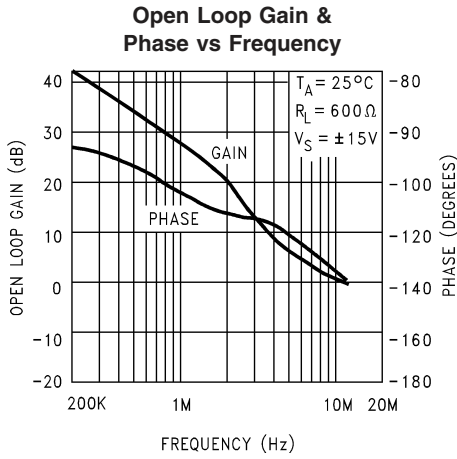

## Typical Performance Characteristics (Continued)

### Small Signal, Non-Inverting

$T_A = 25^\circ\text{C}$ ,  $A_V = 1$ ,  $R_L = 600\Omega$ ,  $V_S = \pm 15\text{V}$

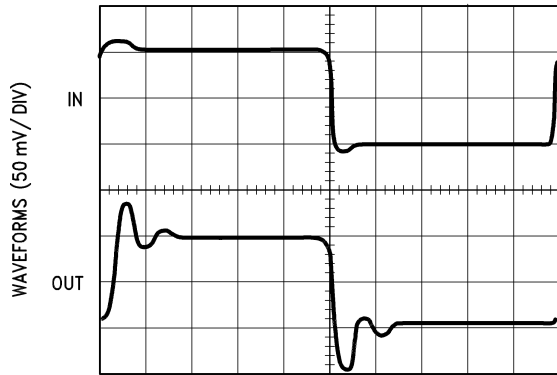

TIME (0.1 μs / DIV)

00904706

### Current Limit

$T_A = 25^\circ\text{C}$ ,  $V_S = \pm 15\text{V}$ ,  $R_L = 100\Omega$ ,  $A_V = 1$

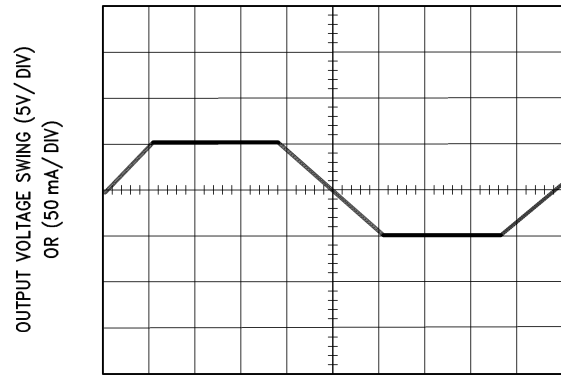

TIME (0.1 ms / DIV)

00904707

### Large Signal Non-Inverting

$T_A = 25^\circ\text{C}$ ,  $R_L = 600\Omega$ ,  $V_S = \pm 15\text{V}$

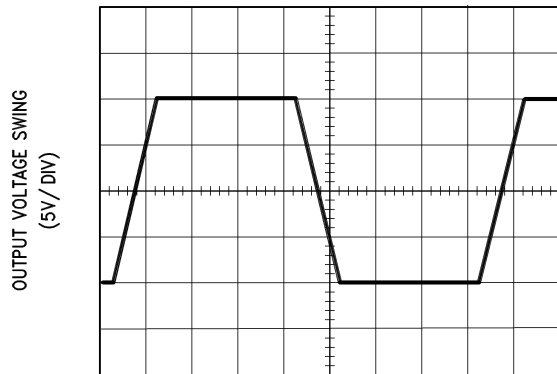

TIME (1 μs / DIV)

00904708

### Large Signal Inverting

$T_A = 25^\circ\text{C}$ ,  $R_L = 600\Omega$ ,  $V_S = \pm 15\text{V}$

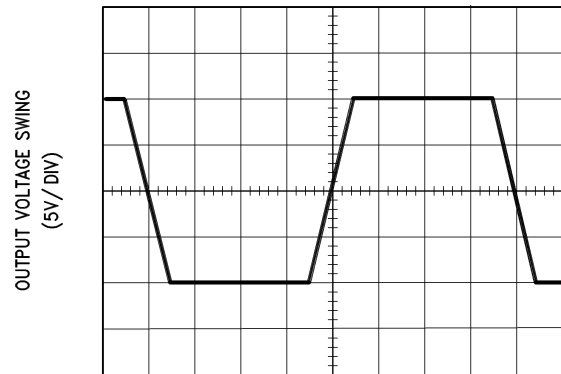

TIME (1 μs / DIV)

00904709



**Physical Dimensions** inches (millimeters) unless otherwise noted

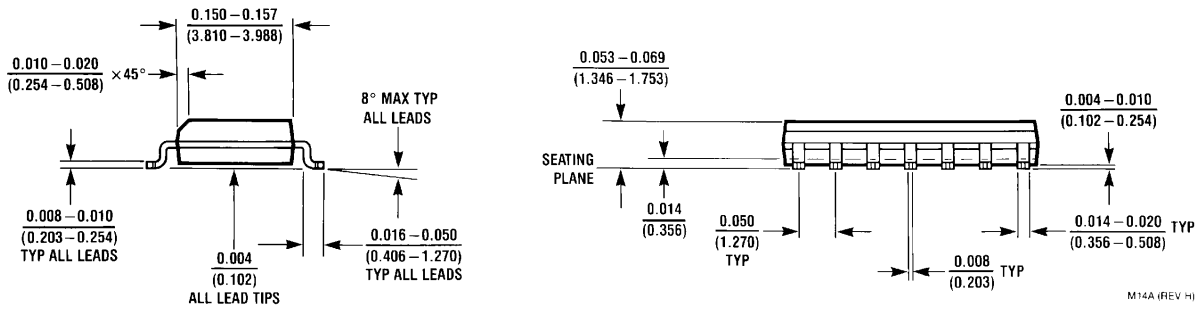
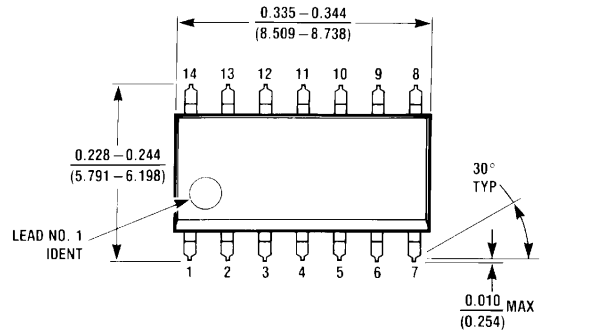

M14A (REV H)

**Molded Package (SO)**  
**Order Number LM837M or LM837MX**  
**NS Package Number M14A**

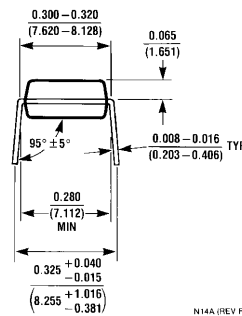
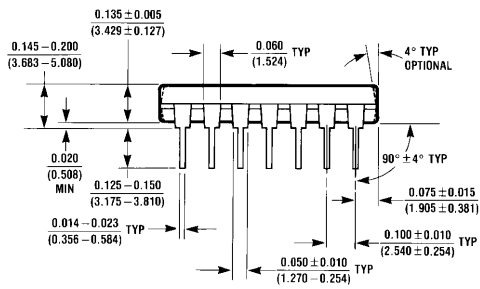
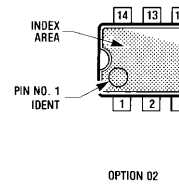
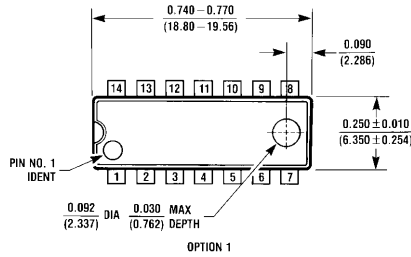

N14A (REV F)

**Lit. #107255**  
**Molded Dual-In-Line Package**  
**Order Number LM837N**  
**NS Package Number N14A**

## Notes

National does not assume any responsibility for use of any circuitry described, no circuit patent licenses are implied and National reserves the right at any time without notice to change said circuitry and specifications.

For the most current product information visit us at [www.national.com](http://www.national.com).

### LIFE SUPPORT POLICY

NATIONAL'S PRODUCTS ARE NOT AUTHORIZED FOR USE AS CRITICAL COMPONENTS IN LIFE SUPPORT DEVICES OR SYSTEMS WITHOUT THE EXPRESS WRITTEN APPROVAL OF THE PRESIDENT AND GENERAL COUNSEL OF NATIONAL SEMICONDUCTOR CORPORATION. As used herein:

1. Life support devices or systems are devices or systems which, (a) are intended for surgical implant into the body, or (b) support or sustain life, and whose failure to perform when properly used in accordance with instructions for use provided in the labeling, can be reasonably expected to result in a significant injury to the user.
2. A critical component is any component of a life support device or system whose failure to perform can be reasonably expected to cause the failure of the life support device or system, or to affect its safety or effectiveness.

### BANNED SUBSTANCE COMPLIANCE

National Semiconductor certifies that the products and packing materials meet the provisions of the Customer Products Stewardship Specification (CSP-9-111C2) and the Banned Substances and Materials of Interest Specification (CSP-9-111S2) and contain no "Banned Substances" as defined in CSP-9-111S2.



**National Semiconductor**  
**Americas Customer**  
**Support Center**  
Email: [new.feedback@nsc.com](mailto:new.feedback@nsc.com)  
Tel: 1-800-272-9959

[www.national.com](http://www.national.com)

**National Semiconductor**  
**Europe Customer Support Center**  
Fax: +49 (0) 180-530 85 86  
Email: [europe.support@nsc.com](mailto:europe.support@nsc.com)  
Deutsch Tel: +49 (0) 69 9508 6208  
English Tel: +44 (0) 870 24 0 2171  
Français Tel: +33 (0) 1 41 91 8790

**National Semiconductor**  
**Asia Pacific Customer**  
**Support Center**  
Email: [ap.support@nsc.com](mailto:ap.support@nsc.com)

**National Semiconductor**  
**Japan Customer Support Center**  
Fax: 81-3-5639-7507  
Email: [jpn.feedback@nsc.com](mailto:jpn.feedback@nsc.com)  
Tel: 81-3-5639-7560