

LMC6044 CMOS Quad Micropower Operational Amplifier

General Description

Ultra-low power consumption and low input-leakage current are the hallmarks of the LMC6044. Providing input currents of only 2 fA typical, the LMC6044 can operate from a single supply, has output swing extending to each supply rail, and an input voltage range that includes ground.

The LMC6044 is ideal for use in systems requiring ultra-low power consumption. In addition, the insensitivity to latch-up, high output drive, and output swing to ground without requiring external pull-down resistors make it ideal for single-supply battery-powered systems.

Other applications for the LMC6044 include bar code reader amplifiers, magnetic and electric field detectors, and hand-held electrometers.

This device is built with National's advanced Double-Poly Silicon-Gate CMOS process.

See the LMC6041 for a single, and the LMC6042 for a dual amplifier with these features.

Features

- Low supply current 10 μ A/Amp (Typ)
- Operates from 4.5V to 15.5V single supply
- Ultra low input current 2 fA (Typ)
- Rail-to-rail output swing
- Input common-mode range includes ground

Applications

- Battery monitoring and power conditioning
- Photodiode and infrared detector preamplifier
- Silicon based transducer systems
- Hand-held analytic instruments
- pH probe buffer amplifier
- Fire and smoke detection systems
- Charge amplifier for piezoelectric transducers

Connection Diagram

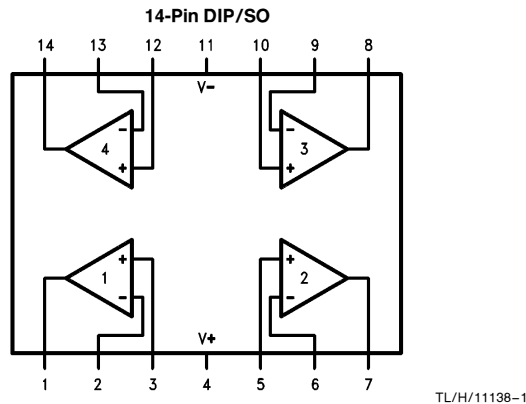

Ordering Information

Package	Temperature Range	NSC Drawing	Transport Media
	Industrial -40°C to +85°C		
14-Pin Small Outline	LMC6044AIM	M14A	Rail Tape and Reel
	LMC6044IIM		
14-Pin Molded DIP	LMC6044AIN	N14A	Rail
	LMC6044IIN		

Absolute Maximum Ratings (Note 1)

If Military/Aerospace specified devices are required, please contact the National Semiconductor Sales Office/Distributors for availability and specifications.

Differential Input Voltage	± Supply Voltage
Supply Voltage ($V^+ - V^-$)	16V
Output Short Circuit to V^+	(Note 12)
Output Short Circuit to V^-	(Note 2)
Lead Temperature (Soldering, 10 sec.)	260°C
Current at Input Pin	± 5 mA
Current at Output Pin	± 18 mA
Current at Power Supply Pin	35 mA
Power Dissipation	(Note 3)
Storage Temperature Range	-65°C to +150°C

Junction Temperature (Note 3)	110°C
ESD Tolerance (Note 4)	500V
Voltage at I/O Pin (V^+)	+ 0.3V, (V^-) - 0.3V

Operating Ratings

Temperature Range	-40°C ≤ T_J ≤ +85°C
LMC6044AI, LMC6044I	
Supply Voltage	4.5V ≤ V^+ ≤ 15.5V
Power Dissipation	(Note 10)
Thermal Resistance (θ_{JA}), (Note 11)	
14-Pin DIP	85°C/W
14-Pin SO	115°C/W

Electrical Characteristics

Unless otherwise specified, all limits guaranteed for $T_A = T_J = 25^\circ\text{C}$. **Boldface** limits apply at the temperature extremes. $V^+ = 5\text{V}$, $V^- = 0\text{V}$, $V_{CM} = 1.5\text{V}$, $V_O = V^+/2$, and $R_L > 1\text{M}$ unless otherwise specified.

Symbol	Parameter	Conditions	Typical (Note 5)	LMC6044AI	LMC6044I	Units (Limit)	
				Limit (Note 6)	Limit (Note 6)		
V_{OS}	Input Offset Voltage		1	3 3.3	6 6.3	mV max	
TCV_{OS}	Input Offset Voltage Average Drift		1.3			$\mu\text{V}/^\circ\text{C}$	
I_B	Input Bias Current		0.002	4	4	pA max	
I_{OS}	Input Offset Current		0.001	2	2	pA max	
R_{IN}	Input Resistance		> 10			Tera Ω	
CMRR	Common Mode Rejection Ratio	$0\text{V} \leq V_{CM} \leq 12.0\text{V}$ $V^+ = 15\text{V}$	75	68 66	62 60	dB min	
+ PSRR	Positive Power Supply Rejection Ratio	$5\text{V} \leq V^+ \leq 15\text{V}$ $V_O = 2.5\text{V}$	75	68 66	62 60	dB min	
- PSRR	Negative Power Supply Rejection Ratio	$0\text{V} \leq V^- \leq -10\text{V}$ $V_O = 2.5\text{V}$	94	84 83	74 73	dB min	
CMR	Input Common-Mode Voltage Range	$V^+ = 5\text{V} \& 15\text{V}$ For CMRR ≥ 50 dB	-0.4	-0.1 0	-0.1 0	V max	
			$V^+ - 1.9\text{V}$	$V^+ - 2.3\text{V}$ $V^+ - 2.5\text{V}$	$V^+ - 2.3\text{V}$ $V^+ - 2.4\text{V}$	V min	
A_V	Large Signal Voltage Gain	$R_L = 100\text{ k}\Omega$ (Note 7)	Sourcing	1000	400 300	300 200	V/mV min
			Sinking	500	180 120	90 70	V/mV min
		$R_L = 25\text{ k}\Omega$ (Note 7)	Sourcing	1000	200 160	100 80	V/mV min
			Sinking	250	100 60	50 40	V/mV min

Electrical Characteristics

Unless otherwise specified, all limits guaranteed for $T_A = T_J = 25^\circ\text{C}$. **Boldface** limits apply at the temperature extremes. $V^+ = 5\text{V}$, $V^- = 0\text{V}$, $V_{CM} = 1.5\text{V}$, $V_O = V^+ / 2$, and $R_L > 1\text{M}$ unless otherwise specified. (Continued)

Symbol	Parameter	Conditions	Typical (Note 5)	LMC6044AI	LMC6044I	Units (Limit)
				Limit (Note 6)	Limit (Note 6)	
V_O	Output Swing	$V^+ = 5\text{V}$ $R_L = 100\text{ k}\Omega$ to 2.5V	4.987	4.970 4.950	4.940 4.910	V min
			0.004	0.030 0.050	0.060 0.090	V max
		$V^+ = 5\text{V}$ $R_L = 25\text{ k}\Omega$ to 2.5V	4.980	4.920 4.870	4.870 4.820	V min
			0.010	0.080 0.130	0.130 0.180	V max
		$V^+ = 15\text{V}$ $R_L = 100\text{ k}\Omega$ to $V^+ / 2$	14.970	14.920 14.880	14.880 14.820	V min
			0.007	0.030 0.050	0.060 0.090	V max
$V^+ = 15\text{V}$ $R_L = 25\text{ k}\Omega$ to $V^+ / 2$	14.950	14.900 14.850	14.850 14.800	V min		
	0.022	0.100 0.150	0.150 0.200	V max		
I_{SC}	Output Current $V^+ = 5\text{V}$	Sourcing, $V_O = 0\text{V}$	22	16 10	13 8	mA min
		Sinking, $V_O = 5\text{V}$	21	16 8	13 8	mA min
I_{SC}	Output Current $V^+ = 15\text{V}$	Sourcing, $V_O = 0\text{V}$	40	15 10	15 10	mA min
		Sinking, $V_O = 13\text{V}$ (Note 12)	39	24 8	21 8	mA min
I_S	Supply Current	Four Amplifiers $V_O = 1.5\text{V}$	40	65 72	75 82	μA max
		Four Amplifiers $V^+ = 15\text{V}$	52	85 94	98 107	μA max

AC Electrical Characteristics Unless otherwise specified, all limits guaranteed for $T_A = T_J = 25^\circ\text{C}$. **Bold-face** limits apply at the temperature extremes. $V^+ = 5\text{V}$, $V^- = 0\text{V}$, $V_{\text{CM}} = 1.5\text{V}$, $V_O = V^+ / 2$, and $R_L > 1\text{M}$ unless otherwise specified.

Symbol	Parameter	Conditions	Typical (Note 5)	LMC6044AI	LMC6044I	Units (Limit)
				Limit (Note 6)	Limit (Note 6)	
SR	Slew Rate	(Note 8)	0.02	0.015 0.010	0.010 0.007	V/ μs min
GBW	Gain-Bandwidth Product		0.10			MHz
ϕ_m	Phase Margin		60			Deg
	Amp-to-Amp Isolation	(Note 9)	115			dB
e_n	Input-Referred Voltage Noise	F = 1 kHz	83			nV/ $\sqrt{\text{Hz}}$
i_n	Input-Referred Current Noise	F = 1 kHz	0.0002			pA/ $\sqrt{\text{Hz}}$
T.H.D.	Total Harmonic Distortion	F = 1 kHz, $A_V = -5$ $R_L = 100\text{ k}\Omega$, $V_O = 2 V_{\text{pp}}$ $\pm 5\text{V}$ Supply	0.01			%

Note 1: Absolute Maximum Ratings indicate limits beyond which damage to the device may occur. Operating Ratings indicate conditions for which the device is intended to be functional, but do not guarantee specific performance limits. For guaranteed specifications and test conditions, see the Electrical Characteristics. The guaranteed specifications apply only for the test conditions listed.

Note 2: Applies to both single-supply and split-supply operation. Continuous short circuit operation at elevated ambient temperature can result in exceeding the maximum allowed junction temperature of 110°C . Output currents in excess of $\pm 30\text{ mA}$ over long term may adversely affect reliability.

Note 3: The maximum power dissipation is a function of $T_{\text{J(max)}}$, θ_{JA} , and T_A . The maximum allowable power dissipation at any ambient temperature is $P_D = (T_{\text{J(max)}} - T_A) / \theta_{\text{JA}}$.

Note 4: Human body model, $1.5\text{ k}\Omega$ in series with 100 pF .

Note 5: Typical Values represent the most likely parametric norm.

Note 6: All limits are guaranteed at room temperature (standard type face) or at operating temperature extremes (**bold face type**).

Note 7: $V^+ = 15\text{V}$, $V_{\text{CM}} = 7.5\text{V}$ and R_L connected to 7.5V . For Sourcing tests, $7.5\text{V} \leq V_O \leq 11.5\text{V}$. For Sinking tests, $2.5\text{V} \leq V_O \leq 7.5\text{V}$.

Note 8: $V^+ = 15\text{V}$. Connected as Voltage Follower with 10V step input. Number specified in the slower of the positive and negative slew rates.

Note 9: Input referred $V^+ = 15\text{V}$ and $R_L = 100\text{ k}\Omega$ connected to $V^+ / 2$. Each amp excited in turn with 100 Hz to produce $V_O = 12 V_{\text{pp}}$.

Note 10: For operating at elevated temperatures, the device must be derated based on the thermal resistance θ_{JA} with $P_D = (T_J - T_A) / \theta_{\text{JA}}$.

Note 11: All numbers apply for packages soldered directly into a PC board.

Note 12: Do not connect output to V^+ when V^+ is greater than 13V or reliability may be adversely affected.

Typical Performance Characteristics $V_S = \pm 7.5V$, $T_A = 25^\circ C$ unless otherwise specified

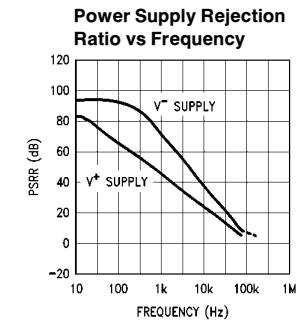
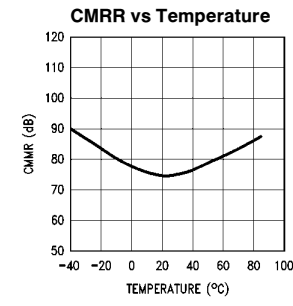
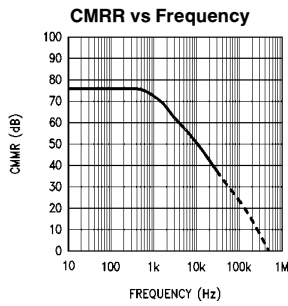
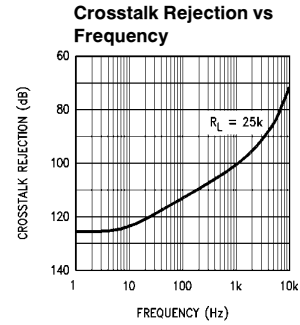
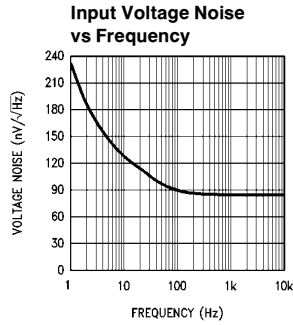
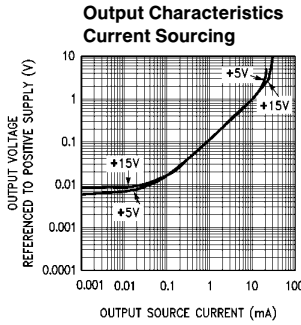
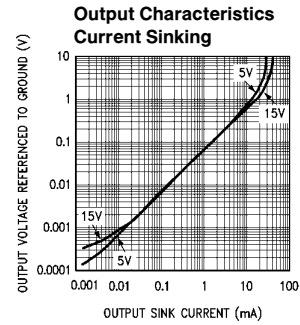
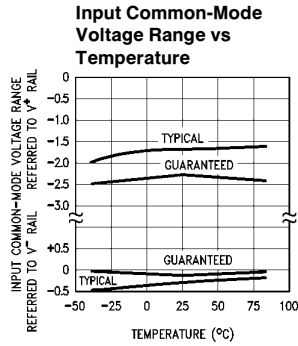
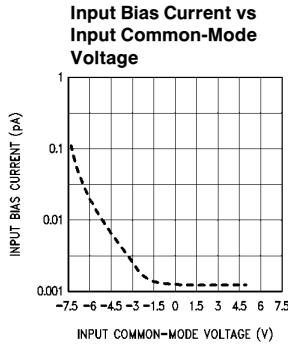
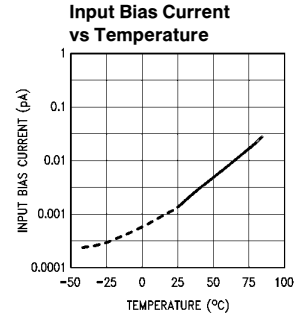
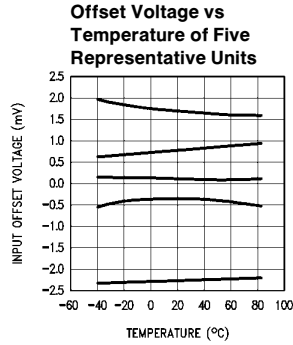
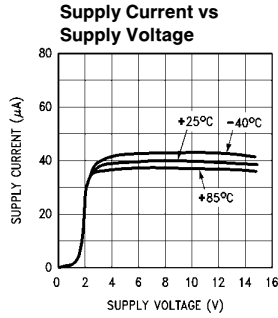

TL/H/11138-2

Typical Performance Characteristics

$V_S = \pm 7.5V$, $T_A = 25^\circ C$ unless otherwise specified (Continued)

Open-Loop Voltage Gain vs Temperature

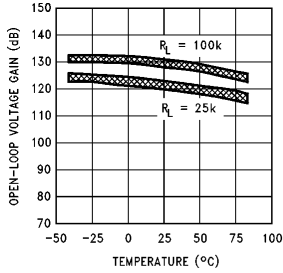

Open-Loop Frequency Response

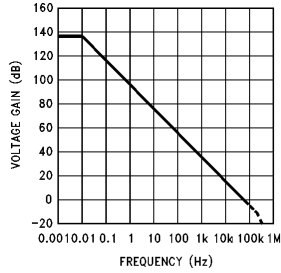

Gain and Phase Responses vs Load Capacitance

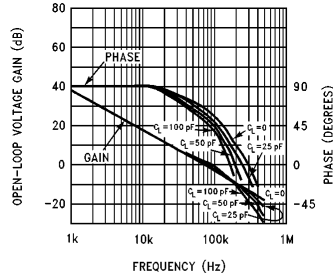

Gain and Phase Responses vs Temperature

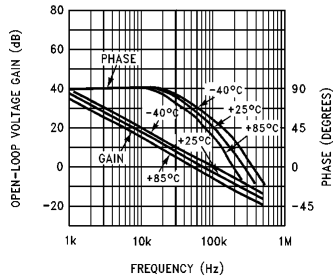

Gain Error (Vos vs Vout)

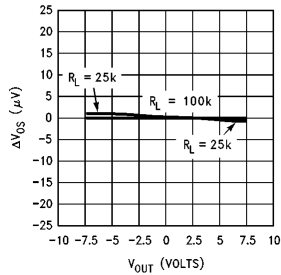

Common-Mode Error vs Common-Mode Voltage of Three Representative Units

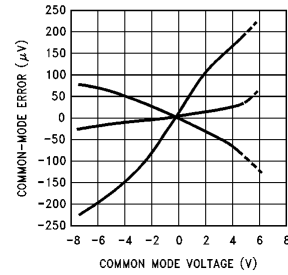

Non-Inverting Slew Rate vs Temperature

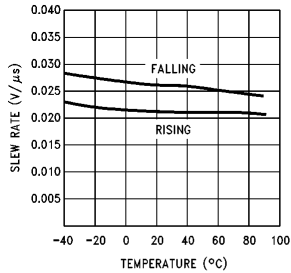

Inverting Slew Rate vs Temperature

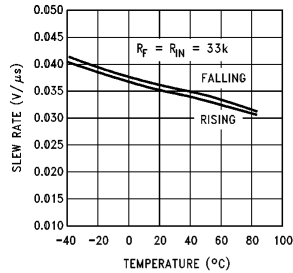

Non-Inverting Large Signal Pulse Response (Av = +1)

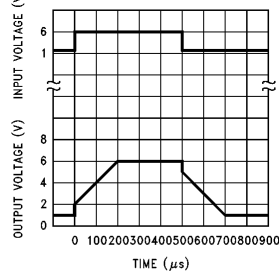

Non-Inverting Small Signal Pulse Response

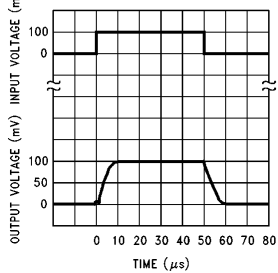

Inverting Large-Signal Pulse Response

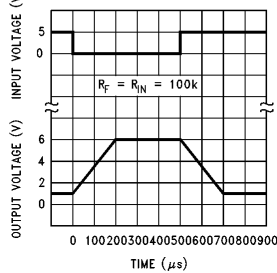

Inverting Small Signal Pulse Response

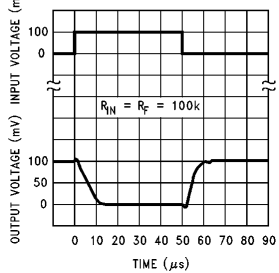

TL/H/11138-3

Typical Performance Characteristics

$V_S = \pm 7.5V$, $T_A = 25^\circ C$ unless otherwise specified (Continued)

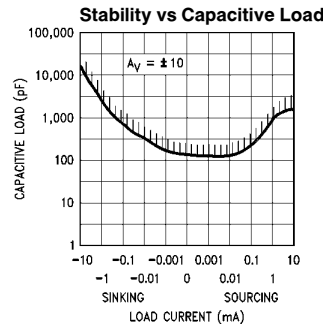
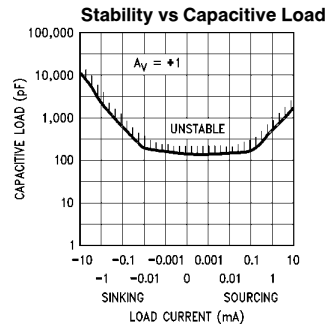

TL/H/11138-4

Application Hints

AMPLIFIER TOPOLOGY

The LMC6044 incorporates a novel op-amp design topology that enables it to maintain rail to rail output swing even when driving a large load. Instead of relying on a push-pull unity gain output buffer stage, the output stage is taken directly from the internal integrator, which provides both low output impedance and large gain. Special feed-forward compensation design techniques are incorporated to maintain stability over a wider range of operating conditions than traditional micropower op-amps. These features make the LMC6044 both easier to design with, and provide higher speed than products typically found in this ultra-low power class.

COMPENSATING FOR INPUT CAPACITANCE

It is quite common to use large values of feedback resistance with amplifiers with ultra-low input current, like the LMC6044.

Although the LMC6044 is highly stable over a wide range of operating conditions, certain precautions must be met to achieve the desired pulse response when a large feedback resistor is used. Large feedback resistors and even small values of input capacitance, due to transducers, photodiodes, and circuits board parasitics, reduce phase margins.

When high input impedance are demanded, guarding of the LMC6044 is suggested. Guarding input lines will not only reduce leakage, but lowers stray input capacitance as well. (See **Printed-Circuit-Board Layout for High Impedance Work.**)

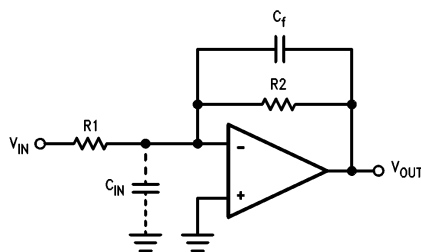

TL/H/11138-5

FIGURE 1. Canceling the Effect of Input Capacitance

The effect of input capacitance can be compensated for by adding a capacitor. Adding a capacitor, C_f , around the feedback resistor (as in *Figure 1*) such that:

$$\frac{1}{2\pi R_1 C_{IN}} \geq \frac{1}{2\pi R_2 C_f}$$

or

$$R_1 C_{IN} \leq R_2 C_f$$

Since it is often difficult to know the exact value of C_{IN} , C_f can be experimentally adjusted so that the desired pulse response is achieved. Refer to the LMC660 and the LMC662 for a more detailed discussion on compensating for input capacitance.

CAPACITIVE LOAD TOLERANCE

Direct capacitive loading will reduce the phase margin of many op-amps. A pole in the feedback loop is created by the combination of the op-amp's output impedance and the capacitive load. This pole induces phase lag at the unity-gain crossover frequency of the amplifier resulting in either an oscillatory or underdamped pulse response. With a few external components, op amps can easily indirectly drive capacitive loads, as shown in *Figure 2a*.

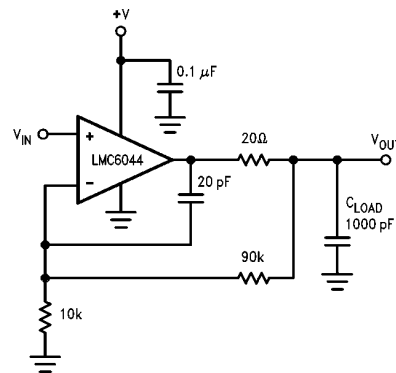

TL/H/11138-6

FIGURE 2a. LMC6044 Noninverting Gain of 10 Amplifier, Compensated to Handle Capacitive Loads

In the circuit of *Figure 2a*, R_1 and C_1 serve to counteract the loss of phase margin by feeding the high frequency component of the output signal back to the amplifier's inverting input, thereby preserving phase margin in the overall feedback loop.

Application Hints (Continued)

Capacitive load driving capability is enhanced by using a pull up resistor to V^+ (Figure 2b). Typically, a pull up resistor conducting $10 \mu A$ or more will significantly improve capacitive load responses. The value of the pull up resistor must be determined based on the current sinking capability of the amplifier with respect to the desired output swing. Open loop gain of the amplifier can also be affected by the pull up resistor (see Electrical Characteristics).

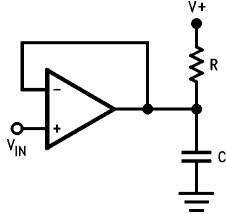

TL/H/11138-18

FIGURE 2b. Compensating for Large Capacitive Loads with a Pull Up Resistor

PRINTED-CIRCUIT-BOARD LAYOUT FOR HIGH-IMPEDANCE WORK

It is generally recognized that any circuit which must operate with less than 1000 pA of leakage current requires special layout of the PC board. When one wishes to take advantage of the ultra-low bias current of the LMC6044, typically less than 2 fA , it is essential to have an excellent layout. Fortunately, the techniques of obtaining low leakages are quite simple. First, the user must not ignore the surface leakage of the PC board, even though it may sometimes appear acceptably low, because under conditions of high humidity or dust or contamination, the surface leakage will be appreciable.

To minimize the effect of any surface leakage, lay out a ring of foil completely surrounding the LMC6044's inputs and the terminals of capacitors, diodes, conductors, resistors, relay terminals, etc. connected to the op-amp's inputs, as in Figure 3. To have a significant effect, guard rings should be placed on both the top and bottom of the PC board. This PC foil must then be connected to a voltage which is at the same voltage as the amplifier inputs, since no leakage current can flow between two points at the same potential. For example, a PC board trace-to-pad resistance of $10^{12} \Omega$,

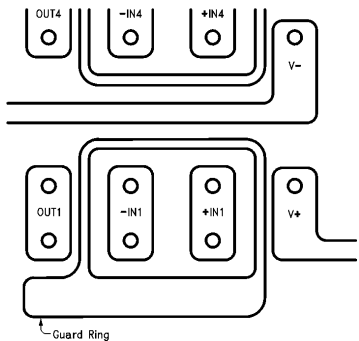

TL/H/11138-7

FIGURE 3. Example of Guard Ring in P.C. Board Layout

which is normally considered a very large resistance, could leak 5 pA if the trace were a 5 V bus adjacent to the pad of the input. This would cause a 100 times degradation from the LMC6044's actual performance. However, if a guard ring is held within 5 mV of the inputs, then even a resistance of $10^{11} \Omega$ would cause only 0.05 pA of leakage current. See Figures 4a, 4b, 4c for typical connections of guard rings for standard op-amp configurations.

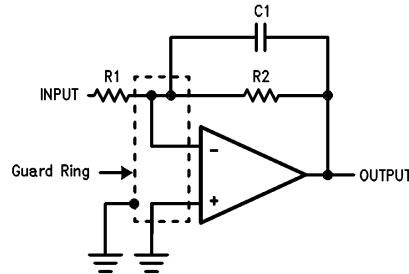

TL/H/11138-8

(a) Inverting Amplifier

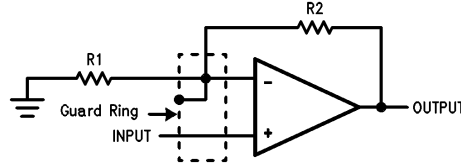

TL/H/11138-10

(b) Non-Inverting Amplifier

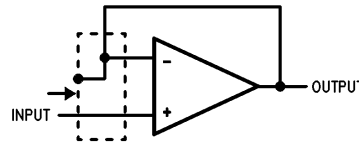

TL/H/11138-9

(c) Follower

FIGURE 4. Typical Connections of Guard Rings

The designer should be aware that when it is inappropriate to lay out a PC board for the sake of just a few circuits, there is another technique which is even better than a guard ring on a PC board: Don't insert the amplifier's input pin into the board at all, but bend it up in the air and use only air as an insulator. Air is an excellent insulator. In this case you may have to forego some of the advantages of PC board construction, but the advantages are sometimes well worth the effort of using point-to-point up-in-the-air wiring. See Figure 5.

Typical Single-Supply Applications ($V_+ = 5.0 V_{DC}$)

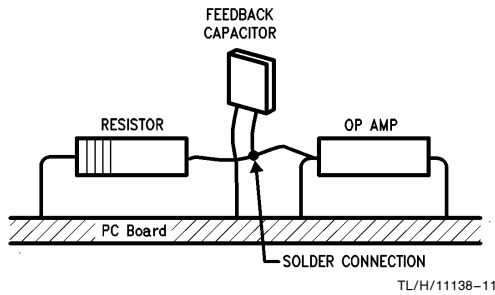

(Input pins are lifted out of PC board and soldered directly to components. All other pins connected to PC board.)

FIGURE 5. Air Wiring

The extremely high input impedance, and low power consumption, of the LMC6044 make it ideal for applications that require battery-powered instrumentation amplifiers. Examples of these type of applications are hand-held pH probes, analytic medical instruments, magnetic field detectors, gas detectors, and silicon based pressure transducers.

The circuit in *Figure 6* is recommended for applications where the common-mode input range is relatively low and the differential gain will be in the range of 10 to 1000. This two op-amp instrumentation amplifier features an independent adjustment of the gain and common-mode rejection trim, and a total quiescent supply current of less than $40 \mu A$. To maintain ultra-high input impedance, it is advisable to

use ground rings and consider PC board layout an important part of the overall system design (see Printed-Circuit-Board Layout for High Impedance Work). Referring to *Figure 6*, the input voltages are represented as a common-mode input V_{CM} plus a differential input V_D . Rejection of the common-mode component of the input is accomplished by making the ratio of R_1/R_2 equal to R_3/R_4 . So that where,

$$\frac{R_3}{R_4} = \frac{R_2}{R_1}$$

$$V_{OUT} = \frac{R_4}{R_3} \left(1 + \frac{R_3}{R_4} + \frac{R_2 + R_3}{R_O} \right) V_D$$

A suggested design guideline is to minimize the difference of value between R_1 through R_4 . This will often result in improved resistor tempco, amplifier gain, and CMRR over temperature. If $R_N = R_1 = R_2 = R_3 = R_4$ then the gain equation can be simplified:

$$V_{OUT} = 2 \left(1 + \frac{R_N}{R_O} \right) V_D$$

Due to the “zero-in, zero-out” performance of the LMC6044, and output swing rail-rail, the dynamic range is only limited to the input common-mode range of $0V$ to $V_S - 2.3V$, worst case at room temperature. This feature of the LMC6044 makes it an ideal choice for low-power instrumentation systems.

A complete instrumentation amplifier designed for a gain of 100 is shown in *Figure 7*. Provisions have been made for low sensitivity trimming of CMRR and gain.

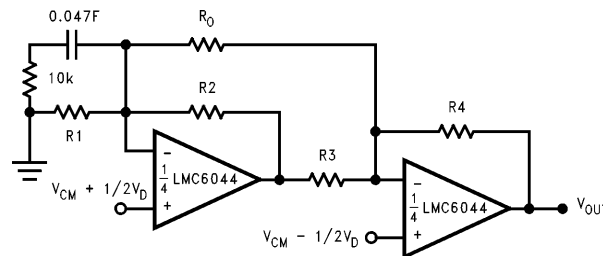

FIGURE 6. Two Op-Amp Instrumentation Amplifier

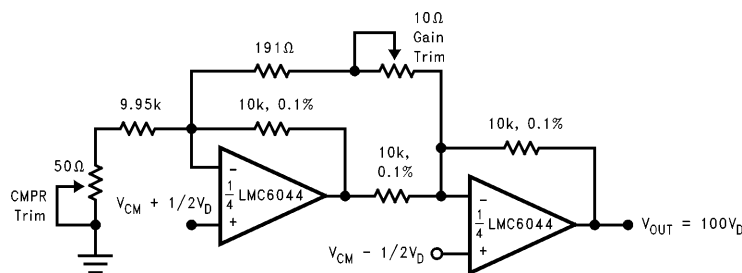

FIGURE 7. Low-Power Two-Op-Amp Instrumentation Amplifier

Typical Single-Supply Applications ($V_+ = 5.0 V_{DC}$) (Continued)

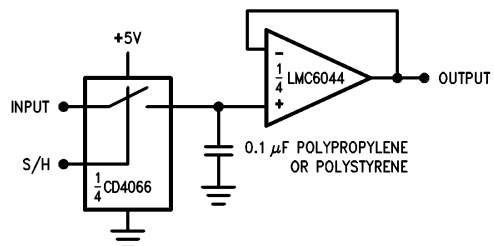

FIGURE 8. Low-Leakage Sample-and-Hold

TL/H/11138-14

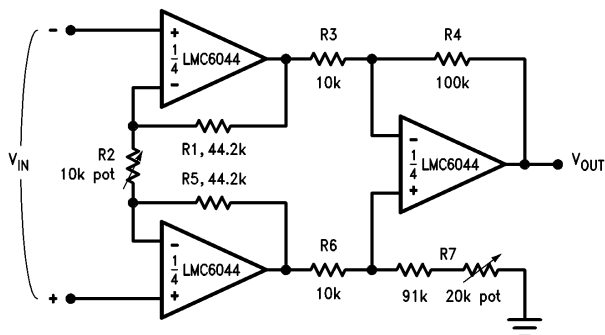

FIGURE 9. Instrumentation Amplifier

TL/H/11138-15

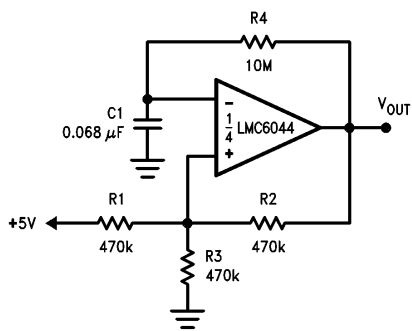

FIGURE 10. 1 Hz Square-Wave Oscillator

TL/H/11138-16

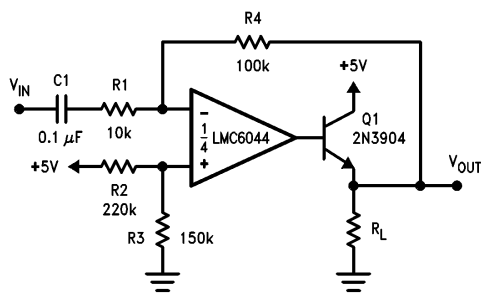
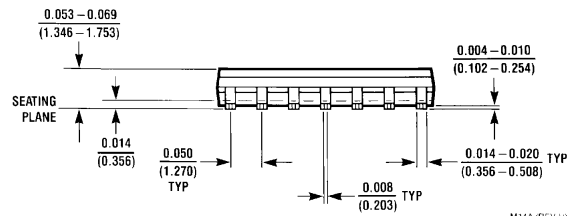
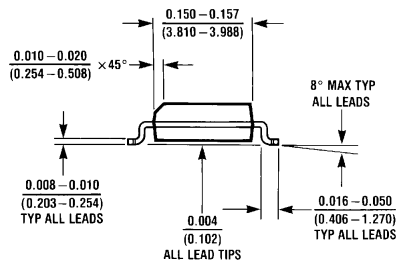
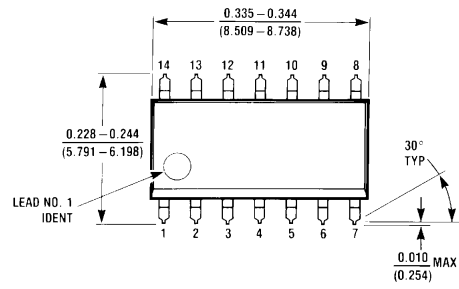

FIGURE 11. AC Coupled Power Amplifier

TL/H/11138-17

Physical Dimensions inches (millimeters)



M14A (REV H)

14-Pin Small Outline
Order Package Number LMC6044AIM or LMC6044IM
NS Package Number M14A

Physical Dimensions inches (millimeters) (Continued)

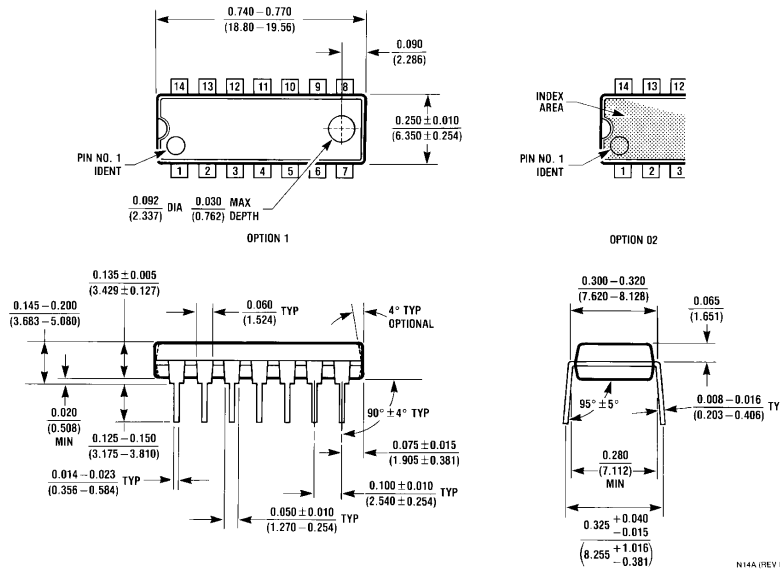

14-Pin Molded DIP
Order Package Number LMC6044AIN or LMC6044IN
NS Package Number N14A

LIFE SUPPORT POLICY

NATIONAL'S PRODUCTS ARE NOT AUTHORIZED FOR USE AS CRITICAL COMPONENTS IN LIFE SUPPORT DEVICES OR SYSTEMS WITHOUT THE EXPRESS WRITTEN APPROVAL OF THE PRESIDENT OF NATIONAL SEMICONDUCTOR CORPORATION. As used herein:

1. Life support devices or systems are devices or systems which, (a) are intended for surgical implant into the body, or (b) support or sustain life, and whose failure to perform, when properly used in accordance with instructions for use provided in the labeling, can be reasonably expected to result in a significant injury to the user.
2. A critical component is any component of a life support device or system whose failure to perform can be reasonably expected to cause the failure of the life support device or system, or to affect its safety or effectiveness.

 <p>National Semiconductor Corporation 2900 Semiconductor Drive P.O. Box 58090 Santa Clara, CA 95052-8090 Tel: (800) 272-9959 TWX: (910) 339-9240</p>	<p>National Semiconductor GmbH Livny-Gargan-Str. 10 D-82256 Fürstenfeldbruck Germany Tel: (81-41) 35-0 Telex: 527849 Fax: (81-41) 35-1</p>	<p>National Semiconductor Japan Ltd. Sumitomo Chemical Engineering Center Bldg. 7F 1-7-1, Nakase, Mihama-Ku Chiba-City, Ciba Prefecture 261 Tel: (043) 299-2300 Fax: (043) 299-2500</p>	<p>National Semiconductor Hong Kong Ltd. 13th Floor, Straight Block, Ocean Centre, 5 Canton Rd. Tsimshatsui, Kowloon Hong Kong Tel: (852) 2737-1600 Fax: (852) 2736-9960</p>	<p>National Semicondutores Do Brazil Ltda. Rue Deputado Lacorda Franco 120-3A Sao Paulo-SP Brazil 05418-000 Tel: (55-11) 212-5066 Telex: 391-1131931 NSBR BR Fax: (55-11) 212-1181</p>	<p>National Semiconductor (Australia) Pty. Ltd. Building 16 Business Park Drive Monash Business Park Nottingham, Melbourne Victoria 3168 Australia Tel: (3) 558-9999 Fax: (3) 558-9998</p>
--	---	---	---	--	--

National does not assume any responsibility for use of any circuitry described, no circuit patent licenses are implied and National reserves the right at any time without notice to change said circuitry and specifications.