

LMC6492 Dual/LMC6494 Quad CMOS Rail-to-Rail Input and Output Operational Amplifier

General Description

The LMC6492/LMC6494 amplifiers were specifically developed for single supply applications that operate from -40°C to $+125^{\circ}\text{C}$. This feature is well-suited for automotive systems because of the wide temperature range. A unique design topology enables the LMC6492/LMC6494 common-mode voltage range to accommodate input signals beyond the rails. This eliminates non-linear output errors due to input signals exceeding a traditionally limited common-mode voltage range. The LMC6492/LMC6494 signal range has a high CMRR of 82 dB for excellent accuracy in non-inverting circuit configurations.

The LMC6492/LMC6494 rail-to-rail input is complemented by rail-to-rail output swing. This assures maximum dynamic signal range which is particularly important in 5V systems.

Ultra-low input current of 150 fA and 120 dB open loop gain provide high accuracy and direct interfacing with high impedance sources.

Features

(Typical unless otherwise noted)

- Rail-to-Rail input common-mode voltage range, guaranteed over temperature
- Rail-to-Rail output swing within 20 mV of supply rail, 100 k Ω load
- Operates from 5V to 15V supply
- Excellent CMRR and PSRR 82 dB
- Ultra low input current 150 fA
- High voltage gain ($R_L = 100\text{ k}\Omega$) 120 dB
- Low supply current (@ $V_S = 5\text{V}$) 500 $\mu\text{A}/\text{Amplifier}$
- Low offset voltage drift 1.0 $\mu\text{V}/^{\circ}\text{C}$

Applications

- Automotive transducer amplifier
- Pressure sensor
- Oxygen sensor
- Temperature sensor
- Speed sensor

Connection Diagrams

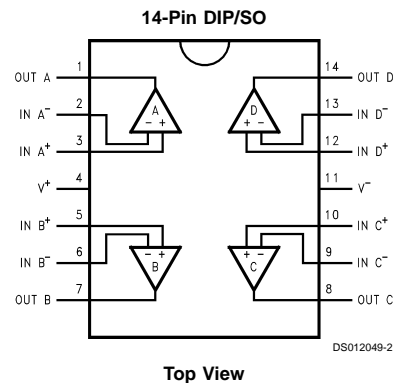
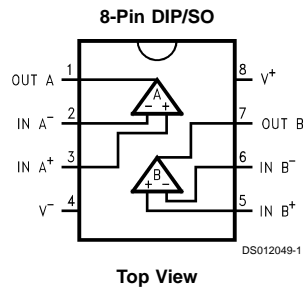

Ordering Information

Package	Temperature Range	Transport Media	NSC Drawing
	Extended -40°C to +125°C		
8-Pin Small Outline	LMC6492AEM LMC6492BEM	Rails	M08A
	LMC6492AEMX LMC6492BEMX	Tape and Reel	
8-Pin Molded DIP	LMC6492AEN LMC6492BEN	Rails	N08A
14-Pin Small Outline	LMC6494AEM LMC6494BEM	Rails	M14A
	LMC6494AEMX LMC6494BEMX	Tape and Reel	
14-Pin Molded DIP	LMC6494AEN LMC6494BEN	Rails	N14A

Absolute Maximum Ratings (Note 1)

If Military/Aerospace specified devices are required, please contact the National Semiconductor Sales Office/Distributors for availability and specifications.

ESD Tolerance (Note 2)	2000V
Differential Input Voltage	±Supply Voltage
Voltage at Input/Output Pin	(V ⁺) + 0.3V, (V ⁻) - 0.3V
Supply Voltage (V ⁺ - V ⁻)	16V
Current at Input Pin	±5 mA
Current at Output Pin (Note 3)	±30 mA
Current at Power Supply Pin	40 mA
Lead Temp. (Soldering, 10 sec.)	260°C
Storage Temperature Range	-65°C to +150°C

Junction Temperature (Note 4)

150°C

Operating Conditions (Note 1)

Supply Voltage	2.5V ≤ V ⁺ ≤ 15.5V
Junction Temperature Range	LMC6492AE, LMC6492BE: -40°C ≤ T _J ≤ +125°C LMC6494AE, LMC6494BE: -40°C ≤ T _J ≤ +125°C
Thermal Resistance (θ _{JA})	N Package, 8-Pin Molded DIP: 108°C/W M Package, 8-Pin Surface Mount: 171°C/W N Package, 14-Pin Molded DIP: 78°C/W M Package, 14-Pin Surface Mount: 118°C/W

DC Electrical Characteristics

Unless otherwise specified, all limits guaranteed for T_J = 25°C, V⁺ = 5V, V⁻ = 0V, V_{CM} = V_O = V⁺/2 and R_L > 1 MΩ. **Bold-face** limits apply at the temperature extremes

Symbol	Parameter	Conditions	Typ (Note 5)	LMC6492AE LMC6494AE Limit (Note 6)	LMC6492BE LMC6494BE Limit (Note 6)	Units
V _{OS}	Input Offset Voltage		0.11	3.0 3.8	6.0 6.8	mV max
TCV _{OS}	Input Offset Voltage Average Drift		1.0			µV/°C
I _B	Input Bias Current	(Note 11)	0.15	200	200	pA max
I _{OS}	Input Offset Current	(Note 11)	0.075	100	100	pA max
R _{IN}	Input Resistance		>10			Tera Ω
C _{IN}	Common-Mode Input Capacitance		3			pF
CMRR	Common-Mode Rejection Ratio	0V ≤ V _{CM} ≤ 15V V ⁺ = 15V	82	65 60	63 58	dB min
		0V ≤ V _{CM} ≤ 5V	82	65 60	63 58	
+PSRR	Positive Power Supply Rejection Ratio	5V ≤ V ⁺ ≤ 15V, V _O = 2.5V	82	65 60	63 58	dB min
-PSRR	Negative Power Supply Rejection Ratio	0V ≤ V ⁻ ≤ -10V, V _O = 2.5V	82	65 60	63 58	dB min
V _{CM}	Input Common-Mode Voltage Range	V ⁺ = 5V and 15V For CMRR ≥ 50 dB	V ⁻ - 0.3	-0.25 0	-0.25 0	V max
			V ⁺ + 0.3	V ⁺ + 0.25 V⁺	V ⁺ + 0.25 V⁺	V min
A _V	Large Signal Voltage Gain	R _L = 2 kΩ: Sourcing (Note 7) Sinking	300			V/mV
			40			min

DC Electrical Characteristics (Continued)

Unless otherwise specified, all limits guaranteed for $T_J = 25^\circ\text{C}$, $V^+ = 5\text{V}$, $V^- = 0\text{V}$, $V_{\text{CM}} = V_O = V^+/2$ and $R_L > 1\text{M}\Omega$. **Bold-face** limits apply at the temperature extremes

Symbol	Parameter	Conditions	Typ (Note 5)	LMC6492AE LMC6494AE Limit (Note 6)	LMC6492BE LMC6494BE Limit (Note 6)	Units		
V_O	Output Swing	$V^+ = 5\text{V}$ $R_L = 2\text{ k}\Omega$ to $V^+/2$	4.9	4.8 4.7	4.8 4.7	V min		
			0.1	0.18 0.24	0.18 0.24	V max		
		$V^+ = 5\text{V}$ $R_L = 600\Omega$ to $V^+/2$	4.7	4.5 4.24	4.5 4.24	V min		
			0.3	0.5 0.65	0.5 0.65	V max		
		$V^+ = 15\text{V}$ $R_L = 2\text{ k}\Omega$ to $V^+/2$	14.7	14.4 14.0	14.4 14.0	V min		
			0.16	0.35 0.5	0.35 0.5	V max		
		$V^+ = 15\text{V}$ $R_L = 600\Omega$ to $V^+/2$	14.1	13.4 13.0	13.4 13.0	V min		
			0.5	1.0 1.5	1.0 1.5	V max		
		I_{SC}	Output Short Circuit Current $V^+ = 5\text{V}$	Sourcing, $V_O = 0\text{V}$	25	16 10	16 10	mA min
				Sinking, $V_O = 5\text{V}$	22	11 8	11 8	
I_{SC}	Output Short Circuit Current $V^+ = 15\text{V}$	Sourcing, $V_O = 0\text{V}$	30	28 20	28 20	mA min		
		Sinking, $V_O = 5\text{V}$ (Note 8)	30	30 22	30 22			
I_S	Supply Current	LMC6492 $V^+ = +5\text{V}$, $V_O = V^+/2$	1.0	1.75 2.1	1.75 2.1	mA max		
		LMC6492 $V^+ = +15\text{V}$, $V_O = V^+/2$	1.3	1.95 2.3	1.95 2.3	mA max		
		LMC6494 $V^+ = +5\text{V}$, $V_O = V^+/2$	2.0	3.5 4.2	3.5 4.2	mA max		
		LMC6494 $V^+ = +15\text{V}$, $V_O = V^+/2$	2.6	3.9 4.6	3.9 4.6	mA max		

AC Electrical Characteristics

Unless otherwise specified, all limits guaranteed for $T_J = 25^\circ\text{C}$, $V^+ = 5\text{V}$, $V^- = 0\text{V}$, $V_{\text{CM}} = V_O = V^+/2$ and $R_L > 1\text{M}\Omega$. **Bold-face** limits apply at the temperature extremes

Symbol	Parameter	Conditions	Typ (Note 5)	LMC6492AE LMC6494AE Limit (Note 6)	LMC6492BE LMC6494BE Limit (Note 6)	Units
SR	Slew Rate	(Note 9)	1.3	0.7 0.5	0.7 0.5	$V/\mu\text{s}$ min
GBW	Gain-Bandwidth Product	$V^+ = 15\text{V}$	1.5			MHz
ϕ_m	Phase Margin		50			Deg
G_m	Gain Margin		15			dB
	Amp-to-Amp Isolation	(Note 10)	150			dB
e_n	Input-Referred Voltage Noise	$F = 1\text{kHz}$ $V_{\text{CM}} = 1\text{V}$	37			$\frac{nV}{\sqrt{Hz}}$
i_n	Input-Referred Current Noise	$F = 1\text{kHz}$	0.06			$\frac{pA}{\sqrt{Hz}}$
T.H.D.	Total Harmonic Distortion	$F = 1\text{kHz}$, $A_V = -2$ $R_L = 10\text{k}\Omega$, $V_O = -4.1\text{V}_{\text{PP}}$	0.01			%
		$F = 10\text{kHz}$, $A_V = -2$ $R_L = 10\text{k}\Omega$, $V_O = 8.5\text{V}_{\text{PP}}$ $V^+ = 10\text{V}$	0.01			

Note 1: Absolute Maximum Ratings indicate limits beyond which damage to the device may occur. Operating Ratings indicate conditions for which the device is intended to be functional, but specific performance is not guaranteed. For guaranteed specifications and the test conditions, see the Electrical Characteristics.

Note 2: Human body model, 1.5 k Ω in series with 100 pF.

Note 3: Applies to both single-supply and split-supply operation. Continuous short operation at elevated ambient temperature can result in exceeding the maximum allowed junction temperature at 150°C. Output currents in excess of $\pm 30\text{mA}$ over long term may adversely affect reliability.

Note 4: The maximum power dissipation is a function of $T_{\text{J(max)}}$, θ_{JA} and T_A . The maximum allowable power dissipation at any ambient temperature is $P_D = (T_{\text{J(max)}} - T_A)/\theta_{\text{JA}}$. All numbers apply for packages soldered directly into a PC board.

Note 5: Typical Values represent the most likely parametric norm.

Note 6: All limits are guaranteed by testing or statistical analysis.

Note 7: $V^+ = 15\text{V}$, $V_{\text{CM}} = 7.5\text{V}$ and R_L connected to 7.5V. For Sourcing tests, $7.5\text{V} \leq V_O \leq 11.5\text{V}$. For Sinking tests, $3.5\text{V} \leq V_O \leq 7.5\text{V}$.

Note 8: Do not short circuit output to V^+ , when V^+ is greater than 13V or reliability will be adversely affected.

Note 9: $V^+ = 15\text{V}$. Connected as voltage follower with 10V step input. Number specified is the slower of the positive and negative slew rates.

Note 10: Input referred, $V^+ = 15\text{V}$ and $R_L = 100\text{k}\Omega$ connected to 7.5V. Each amp excited in turn with 1 kHz to produce $V_O = 12\text{V}_{\text{PP}}$.

Note 11: Guaranteed limits are dictated by tester limits and not device performance. Actual performance is reflected in the typical value.

Typical Performance Characteristics $V_S = +15\text{V}$, Single Supply, $T_A = 25^\circ\text{C}$ unless otherwise specified

Supply Current vs
Supply Voltage

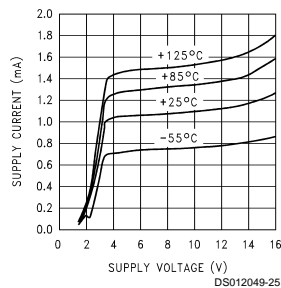

Input Current vs
Temperature

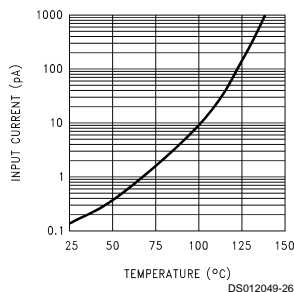

Sourcing Current vs
Output Voltage

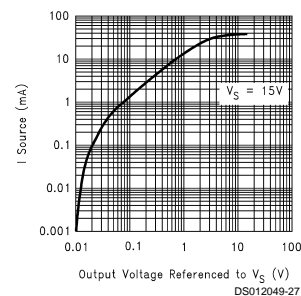

Typical Performance Characteristics $V_S = +15V$, Single Supply, $T_A = 25^\circ C$ unless otherwise specified (Continued)

Sourcing Current vs Output Voltage

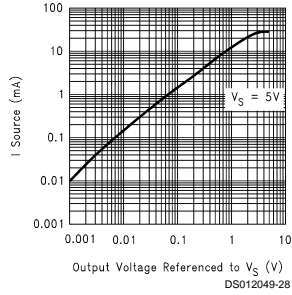

Sourcing Current vs Output Voltage

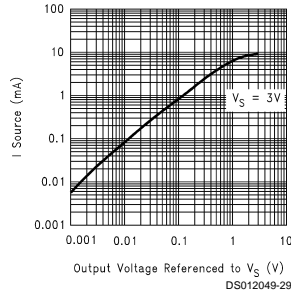

Sinking Current vs Output Voltage

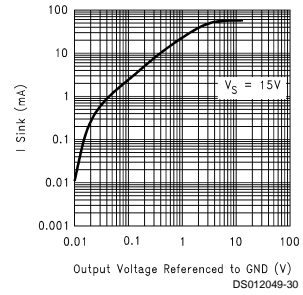

Sinking Current vs Output Voltage

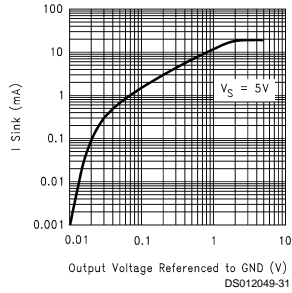

Sinking Current vs Output Voltage

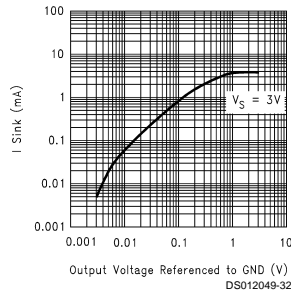

Output Voltage Swing vs Supply Voltage

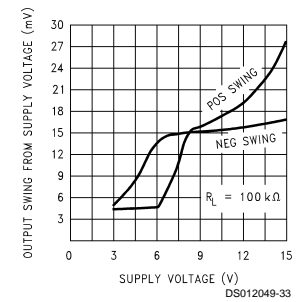

Input Voltage Noise vs Frequency

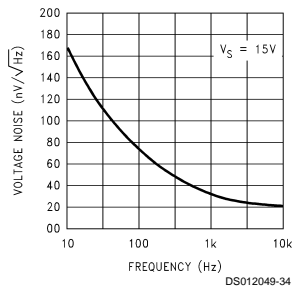

Input Voltage Noise vs Input Voltage

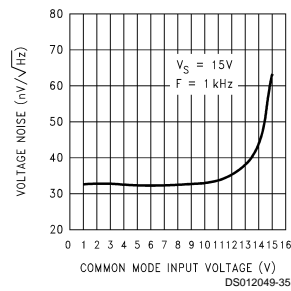

Input Voltage Noise vs Input Voltage

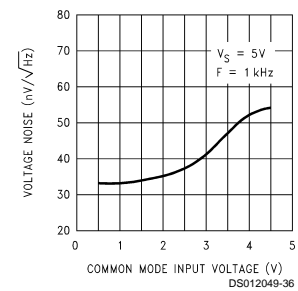

Typical Performance Characteristics $V_S = +15V$, Single Supply, $T_A = 25^\circ C$ unless otherwise specified (Continued)

Input Voltage Noise vs Input Voltage

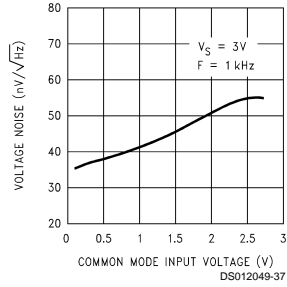

Crosstalk Rejection vs Frequency

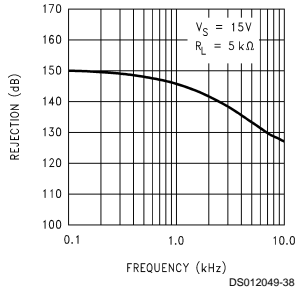

Crosstalk Rejection vs Frequency

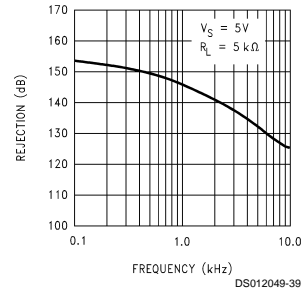

Positive PSRR vs Frequency

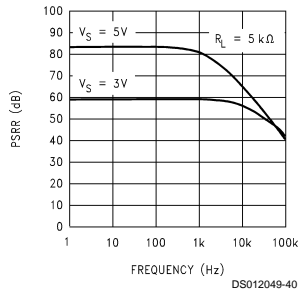

Negative PSRR vs Frequency

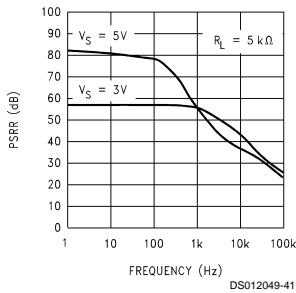

CMRR vs Frequency

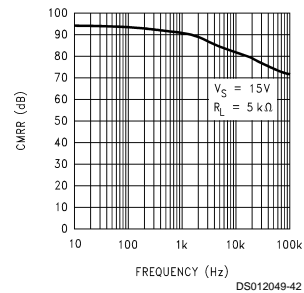

CMRR vs Input Voltage

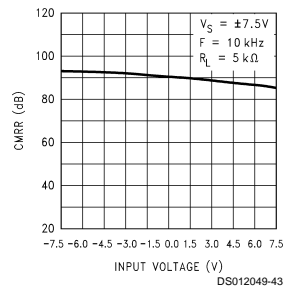

CMRR vs Input Voltage

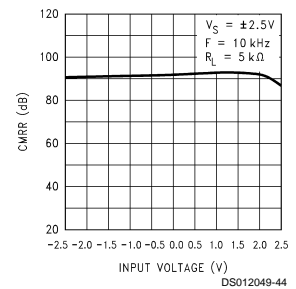

CMRR vs Input Voltage

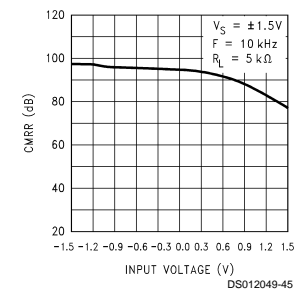

Typical Performance Characteristics $V_S = +15V$, Single Supply, $T_A = 25^\circ C$ unless otherwise specified (Continued)

ΔV_{OS} vs CMR

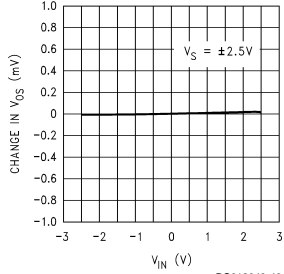

ΔV_{OS} vs CMR

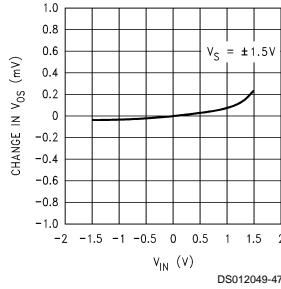

Input Voltage vs Output Voltage

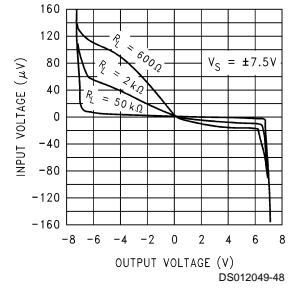

Input Voltage vs Output Voltage

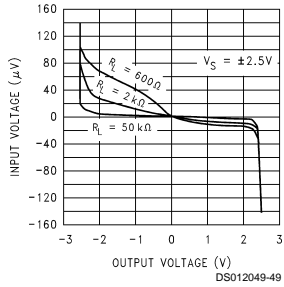

Open Loop Frequency Response

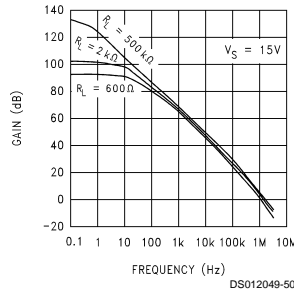

Open Loop Frequency Response

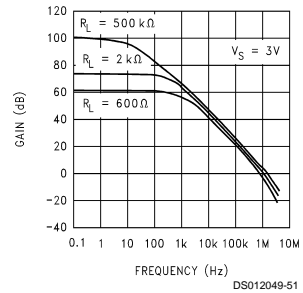

Open Loop Frequency Response vs Temperature

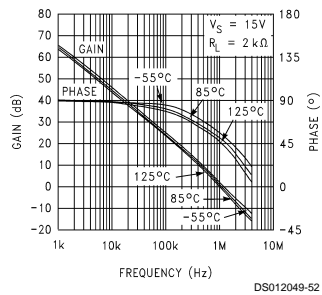

Maximum Output Swing vs Frequency

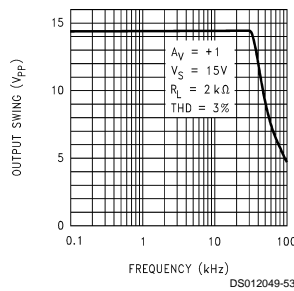

Gain and Phase vs Capacitive Load

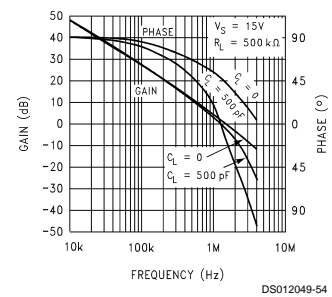

Typical Performance Characteristics $V_S = +15V$, Single Supply, $T_A = 25^\circ C$ unless otherwise specified (Continued)

Gain and Phase vs Capacitive Load

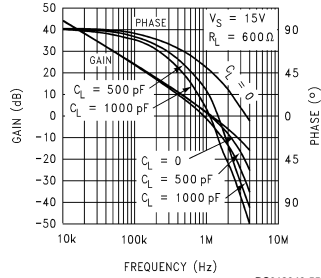

DS012049-55

Open Loop Output Impedance vs Frequency

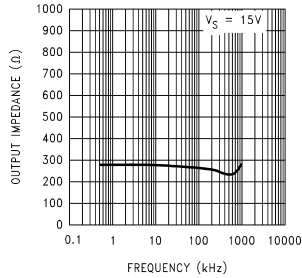

DS012049-56

Open Loop Output Impedance vs Frequency

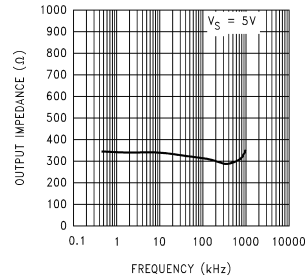

DS012049-57

Slew Rate vs Supply Voltage

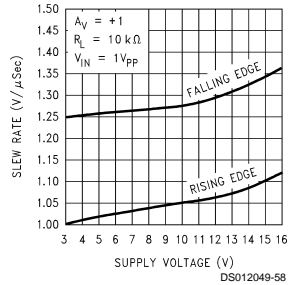

DS012049-58

Non-Inverting Large Signal Pulse Response

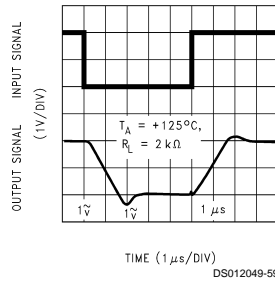

DS012049-59

Non-Inverting Large Signal Pulse Response

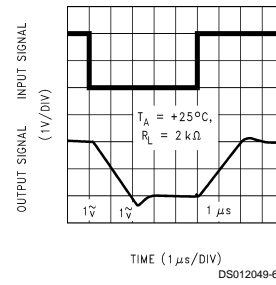

DS012049-60

Non-Inverting Large Signal Pulse Response

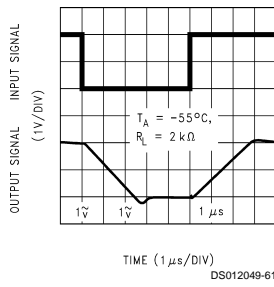

DS012049-61

Non-Inverting Small Signal Pulse Response

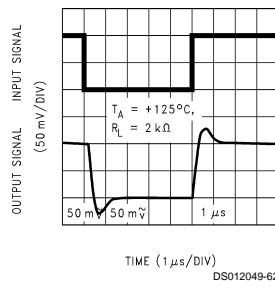

DS012049-62

Non-Inverting Small Signal Pulse Response

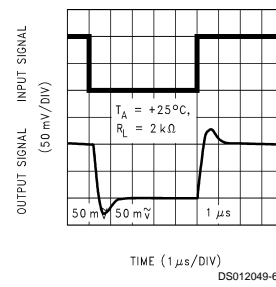

DS012049-63

Typical Performance Characteristics $V_S = +15V$, Single Supply, $T_A = 25^\circ C$ unless otherwise specified (Continued)

Non-Inverting Small Signal Pulse Response

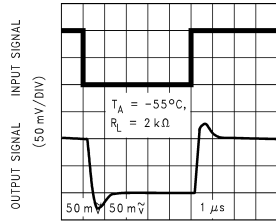

TIME (1 μs/DIV)
DS012049-64

Inverting Large Signal Pulse Response

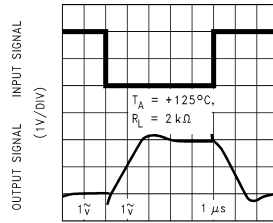

TIME (1 μs/DIV)
DS012049-65

Inverting Large Signal Pulse Response

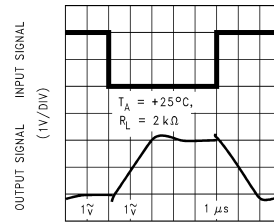

TIME (1 μs/DIV)
DS012049-66

Inverting Large Signal Pulse Response

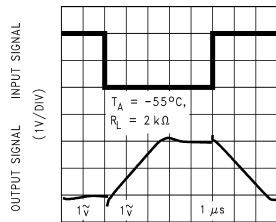

TIME (1 μs/DIV)
DS012049-67

Inverting Small Signal Pulse Response

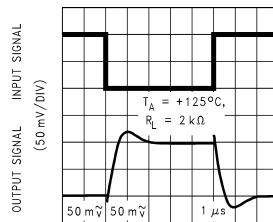

TIME (1 μs/DIV)
DS012049-68

Inverting Small Signal Pulse Response

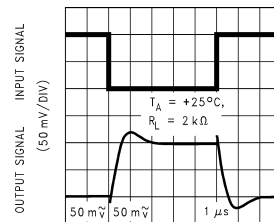

TIME (1 μs/DIV)
DS012049-69

Inverting Small Signal Pulse Response

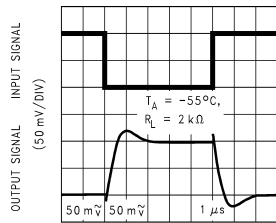

TIME (1 μs/DIV)
DS012049-70

Stability vs Capacitive Load

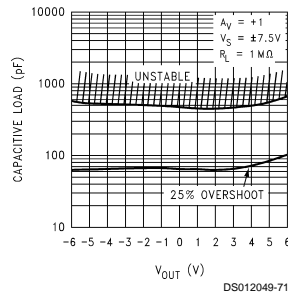

DS012049-71

Stability vs Capacitive Load

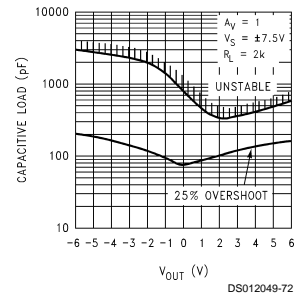

DS012049-72

Typical Performance Characteristics $V_S = +15V$, Single Supply, $T_A = 25^\circ C$ unless otherwise specified (Continued)

Stability vs Capacitive Load

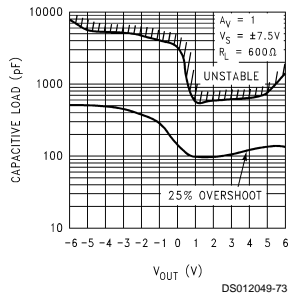

Stability vs Capacitive Load

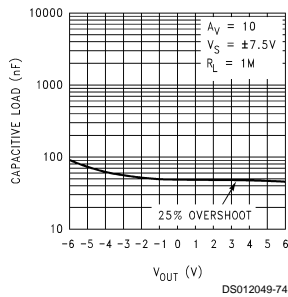

Stability vs Capacitive Load

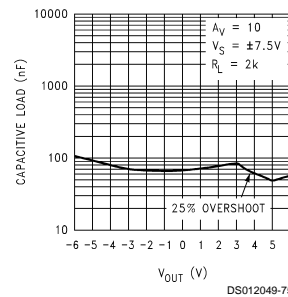

Stability vs Capacitive Load

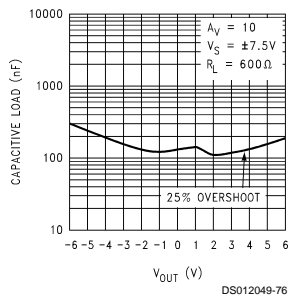

Application Notes

Input Common-Mode Voltage Range

Unlike Bi-FET amplifier designs, the LMC6492/4 does not exhibit phase inversion when an input voltage exceeds the negative supply voltage. *Figure 1* shows an input voltage exceeding both supplies with no resulting phase inversion on the output.

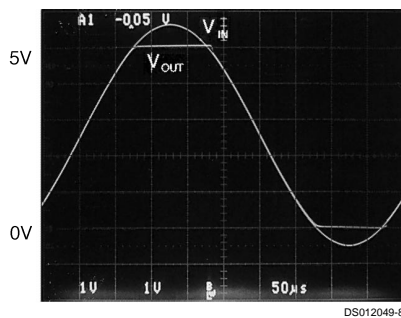

FIGURE 1. An Input Voltage Signal Exceeds the LMC6492/4 Power Supply Voltages with No Output Phase Inversion

The absolute maximum input voltage is 300 mV beyond either supply rail at room temperature. Voltages greatly ex-

ceeding this absolute maximum rating, as in *Figure 2*, can cause excessive current to flow in or out of the input pins possibly affecting reliability.

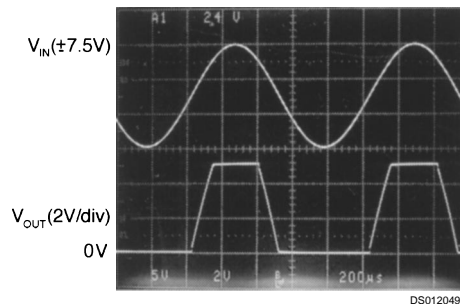

FIGURE 2. A ±7.5V Input Signal Greatly Exceeds the 5V Supply in *Figure 3* Causing No Phase Inversion Due to R_i

Applications that exceed this rating must externally limit the maximum input current to ± 5 mA with an input resistor (R_i) as shown in *Figure 3*.

Application Notes (Continued)

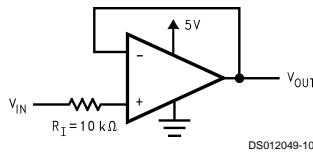

FIGURE 3. R_1 Input Current Protection for Voltages Exceeding the Supply Voltages

Rail-To-Rail Output

The approximate output resistance of the LMC6492/4 is 110Ω sourcing and 80Ω sinking at $V_s = 5\text{V}$. Using the calculated output resistance, maximum output voltage swing can be estimated as a function of load.

Compensating for Input Capacitance

It is quite common to use large values of feedback resistance for amplifiers with ultra-low input current, like the LMC6492/4.

Although the LMC6492/4 is highly stable over a wide range of operating conditions, certain precautions must be met to achieve the desired pulse response when a large feedback resistor is used. Large feedback resistors with even small values of input capacitance, due to transducers, photodiodes, and circuit board parasitics, reduce phase margins.

When high input impedances are demanded, guarding of the LMC6492/4 is suggested. Guarding input lines will not only reduce leakage, but lowers stray input capacitance as well. (See *Printed-Circuit-Board Layout for High Impedance Work*).

The effect of input capacitance can be compensated for by adding a capacitor, C_f , around the feedback resistors (as in Figure 1) such that:

$$\frac{1}{2\pi R_1 C_{IN}} \geq \frac{1}{2\pi R_2 C_f}$$

or

$$R_1 C_{IN} \leq R_2 C_f$$

Since it is often difficult to know the exact value of C_{IN} , C_f can be experimentally adjusted so that the desired pulse response is achieved. Refer to the LMC660 and LMC662 for a more detailed discussion on compensating for input capacitance.

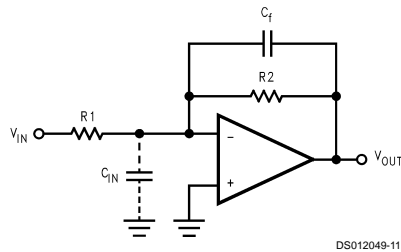

FIGURE 4. Cancelling the Effect of Input Capacitance

Capacitive Load Tolerance

All rail-to-rail output swing operational amplifiers have voltage gain in the output stage. A compensation capacitor is normally included in this integrator stage. The frequency location of the dominant pole is affected by the resistive load on the amplifier. Capacitive load driving capability can be optimized by using an appropriate resistive load in parallel with the capacitive load (see Typical Curves).

Direct capacitive loading will reduce the phase margin of many op-amps. A pole in the feedback loop is created by the combination of the op-amp's output impedance and the capacitive load. This pole induces phase lag at the unity-gain crossover frequency of the amplifier resulting in either an oscillatory or underdamped pulse response. With a few external components, op amps can easily indirectly drive capacitive loads, as shown in Figure 5.

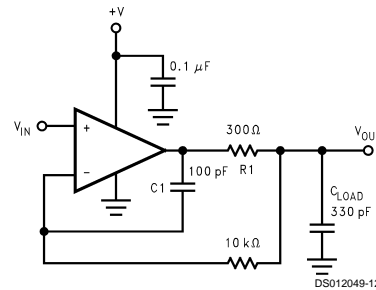

FIGURE 5. LMC6492/4 Noninverting Amplifier, Compensated to Handle Capacitive Loads

Printed-Circuit-Board Layout for High-Impedance Work

It is generally recognized that any circuit which must operate with less than 1000 pA of leakage current requires special layout of the PC board. When one wishes to take advantage of the ultra-low bias current of the LMC6492/4, typically 150 fA , it is essential to have an excellent layout. Fortunately, the techniques of obtaining low leakages are quite simple. First, the user must not ignore the surface leakage of the PC board, even though it may sometimes appear acceptably low, because under conditions of high humidity or dust or contamination, the surface leakage will be appreciable.

To minimize the effect of any surface leakage, lay out a ring of foil completely surrounding the LMC6492/4's inputs and the terminals of components connected to the op-amp's inputs, as in Figure 6. To have a significant effect, guard rings should be placed on both the top and bottom of the PC board. This PC foil must then be connected to a voltage which is at the same voltage as the amplifier inputs, since no leakage current can flow between two points at the same potential. For example, a PC board trace-to-pad resistance of $10^{12}\Omega$, which is normally considered a very large resistance, could leak 5 pA if the trace were a 5V bus adjacent to the pad of the input.

This would cause a 33 times degradation from the LMC6492/4's actual performance. If a guard ring is used and held within 5 mV of the inputs, then the same resistance of $10^{11}\Omega$ will only cause 0.05 pA of leakage current. See Figure 7 for typical connections of guard rings for standard op-amp configurations.

Application Notes (Continued)

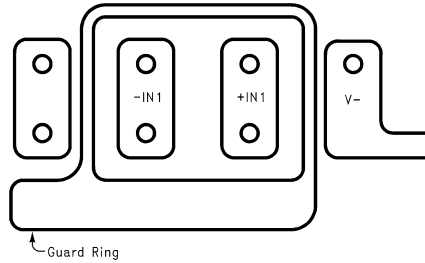

DS012049-13

FIGURE 6. Examples of Guard Ring in PC Board Layout

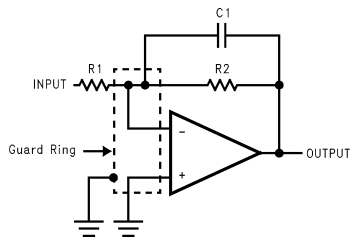

DS012049-14

Inverting Amplifier

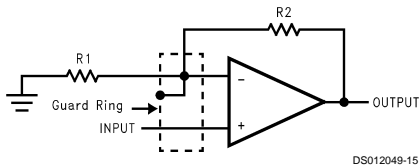

DS012049-15

Non-Inverting Amplifier

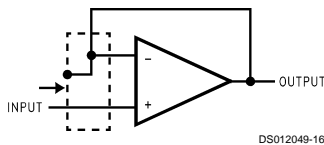

DS012049-16

Follower

FIGURE 7. Typical Connections of Guard Rings

The designer should be aware that when it is inappropriate to lay out a PC board for the sake of just a few circuits, there is another technique which is even better than a guard ring on a PC board: Don't insert the amplifier's input pin into the board at all, but bend it up in the air and use only air as an insulator. Air is an excellent insulator. In this case you may have to forego some of the advantages of PC board construction, but the advantages are sometimes well worth the effort of using point-to-point up-in-the-air wiring. See *Figure 8*.

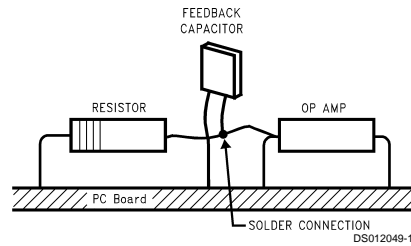

DS012049-17

(Input pins are lifted out of PC board and soldered directly to components. All other pins connected to PC board).

FIGURE 8. Air Wiring

Application Circuits

DC Summing Amplifier ($V_{IN} \geq 0V_{DC}$ and $V_O \geq V_{DC}$)

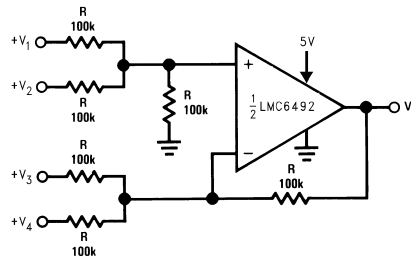

DS012049-18

Where: $V_O = V_1 + V_2 - V_3 - V_4$
 $(V_1 + V_2 \geq (V_3 + V_4)$ to keep $V_O > 0V_{DC}$

Application Circuits (Continued)

High Input Z, DC Differential Amplifier

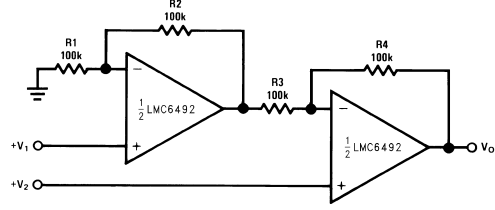

DS012049-19

For

$$\frac{R1}{R2} = \frac{R4}{R3}$$

(CMRR depends on this resistor ratio match)

$$V_O = 1 + \frac{R4}{R3} (V_2 - V_1)$$

As shown: $V_O = 2(V_2 - V_1)$

Photo Voltaic-Cell Amplifier

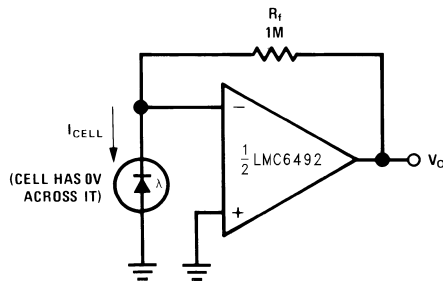

DS012049-20

Instrumentation Amplifier

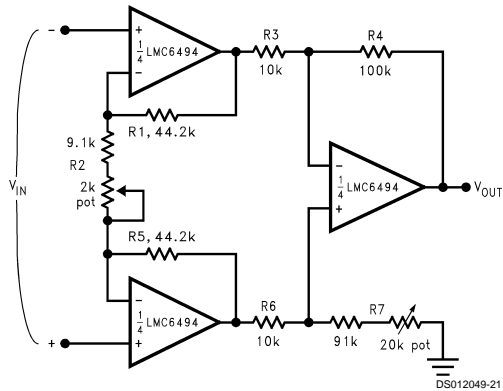

DS012049-21

If $R1 = R5$, $R3 = R6$, and $R4 = R7$; then

$$\frac{V_{OUT}}{V_{IN}} = \frac{R2 + 2R1}{R2} \times \frac{R4}{R3}$$

$\therefore A_v = 100$ for circuit shown ($R2 = 9.3k$).

Rail-to-Rail Single Supply Low Pass Filter

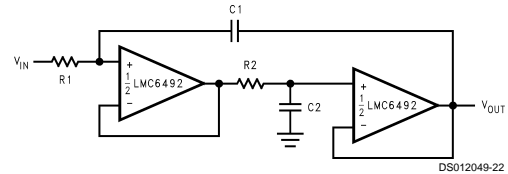

DS012049-22

$$R1 = R2, C1 = C2; f = \frac{1}{2\pi R1 C1}; \text{Damping Factor} = \frac{1}{2} \sqrt{\frac{C2}{C1}} \sqrt{\frac{R2}{R1}}$$

This low-pass filter circuit can be used as an anti-aliasing filter with the same supply as the A/D converter. Filter designs can also take advantage of the LMC6492/4 ultra-low input current. The ultra-low input current yields negligible offset error even when large value resistors are used. This in turn allows the use of smaller valued capacitors which take less board space and cost less.

Low Voltage Peak Detector with Rail-to-Rail Peak Capture Range

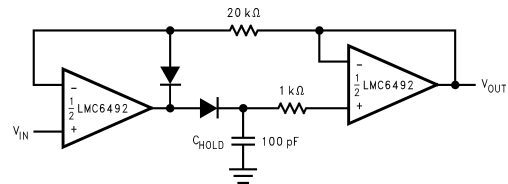

DS012049-23

Dielectric absorption and leakage is minimized by using a polystyrene or polypropylene hold capacitor. The droop rate is primarily determined by the value of C_H and diode leakage current. Select low-leakage current diodes to minimize drooping.

Pressure Sensor

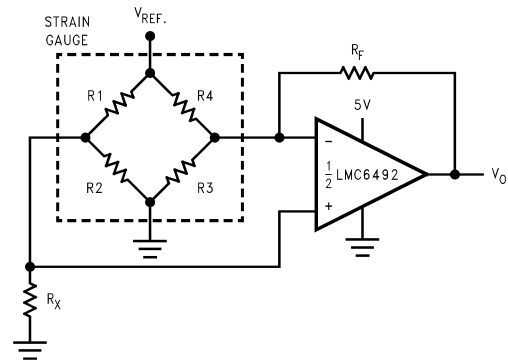

DS012049-24

$R_f = R_x$
 $R_f \gg R1, R2, R3, \text{ and } R4$

$$V_O = \left(\frac{R2}{R1 + R2} - \frac{R3}{R4 + R3} \right) \frac{R_f (R3 + R4)}{R3 R4} V_{REF}$$

In a manifold absolute pressure sensor application, a strain gauge is mounted on the intake manifold in the engine unit. Manifold pressure causes the sensing resistors, $R1, R2, R3$

Application Circuits (Continued)

and R4 to change. The resistors change in a way such that R2 and R4 increase by the same amount R1 and R3 decrease. This causes a differential voltage between the input of the amplifier. The gain of the amplifier is adjusted by R₁.

Spice Macromodel

A spice macromodel is available for the LMC6492/4. This model includes accurate simulation of:

- Input common-mode voltage range
 - Frequency and transient response
 - GBW dependence on loading conditions
 - Quiescent and dynamic supply current
 - Output swing dependence on loading conditions
- and many other characteristics as listed on the macromodel disk.

Contact your local National Semiconductor sales office to obtain an operational amplifier spice model library disk.

Physical Dimensions inches (millimeters) unless otherwise noted

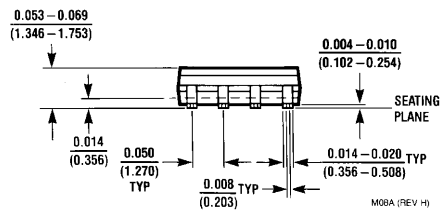
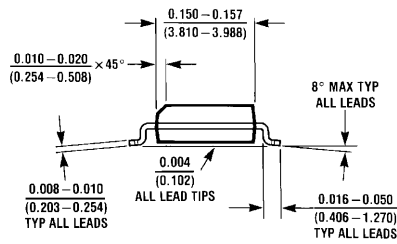
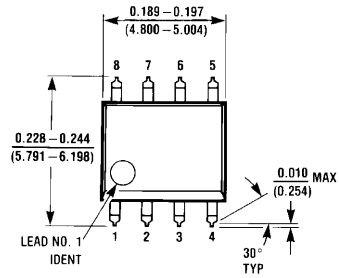

8-Pin Small Outline Package
Order Number LMC6492AEM or LMC6492BEM
NS Package Number M08A

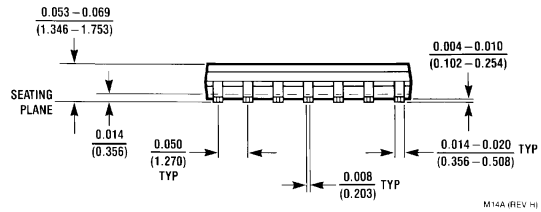
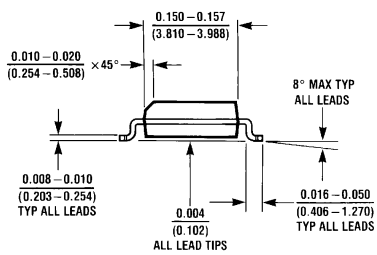
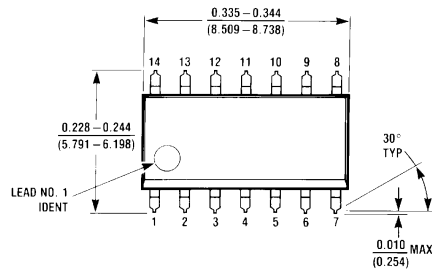

14-Pin Small Outline Package
Order Number LMC6494AEM or LMC6494BEM
NS Package Number M14A

LIFE SUPPORT POLICY

NATIONAL'S PRODUCTS ARE NOT AUTHORIZED FOR USE AS CRITICAL COMPONENTS IN LIFE SUPPORT DEVICES OR SYSTEMS WITHOUT THE EXPRESS WRITTEN APPROVAL OF THE PRESIDENT OF NATIONAL SEMICONDUCTOR CORPORATION. As used herein:

1. Life support devices or systems are devices or systems which, (a) are intended for surgical implant into the body, or (b) support or sustain life, and whose failure to perform when properly used in accordance with instructions for use provided in the labeling, can be reasonably expected to result in a significant injury to the user.
2. A critical component is any component of a life support device or system whose failure to perform can be reasonably expected to cause the failure of the life support device or system, or to affect its safety or effectiveness.



National Semiconductor Corporation
Americas
Tel: 1-800-272-9959
Fax: 1-800-737-7018
Email: support@nsc.com

www.national.com

National Semiconductor Europe
Fax: +49 (0) 1 80-530 85 86
Email: europe.support@nsc.com
Deutsch Tel: +49 (0) 1 80-530 85 85
English Tel: +49 (0) 1 80-532 78 32
Français Tel: +49 (0) 1 80-532 93 58
Italiano Tel: +49 (0) 1 80-534 16 80

National Semiconductor Asia Pacific Customer Response Group
Tel: 65-2544466
Fax: 65-2504466
Email: sea.support@nsc.com

National Semiconductor Japan Ltd.
Tel: 81-3-5639-7560
Fax: 81-3-5639-7507