

LMC6572 Dual/LMC6574 Quad Low Voltage (2.7V and 3V) Operational Amplifier

General Description

Low voltage operation and low power dissipation make the LMC6574/2 ideal for battery-powered systems.

3V amplifier performance is backed by 2.7V guarantees to ensure operation throughout battery lifetime. These guarantees also enable analog circuits to operate from the same 3.3V supply used for digital logic.

Battery life is maximized because each amplifier dissipates only micro-watts of power.

The LMC6574/2 does not sacrifice functionality for low voltage operation. The LMC6574/2 generates 120 dB of open-loop gain just like a conventional amplifier, but the LMC6574/2 can do this from a 2.7V supply.

These amplifiers are designed with features that optimize low voltage operation. The output voltage swings rail-to-rail to maximize signal-to-noise ratio and dynamic signal range. The common-mode input voltage range extends from 800 mV below the positive supply to 100 mV below ground.

This device is built with National's advanced Double-Poly Silicon-Gate CMOS process.

LMC6572 is also available in MSOP package which is almost half the size of a SO-8 device.

Features

(Typical unless otherwise noted)

- Guaranteed 2.7V and 3V Performance
- Rail-to-Rail Output Swing (within 5 mV of supply rail, 100 k Ω load)
- Ultra-Low Supply Current: 40 μ A/Amplifier
- Low Cost
- Ultra-Low Input Current: 20 fA
- High Voltage Gain @ $V_S=2.7V$, $R_L=100\text{ k}\Omega$: 120 dB
- Specified for 100 k Ω and 5 k Ω loads
- Available in MSOP Package

Applications

- Transducer Amplifier
- Portable or Remote Equipment
- Battery-Operated Instruments
- Data Acquisition Systems
- Medical Instrumentation
- Improved Replacement for TLV2322 and TLV2324

Connection Diagrams

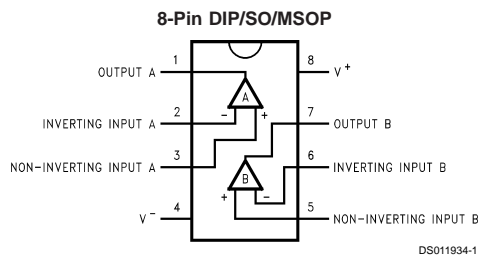

Order Number **LMC6572AIN**, **LMC6572BIN**,
LMC6572AIM, **LMC6572BIM** or **LMC6572BIMM**
See NS Package Number **N08E**, **M08A** or **MUA08A**

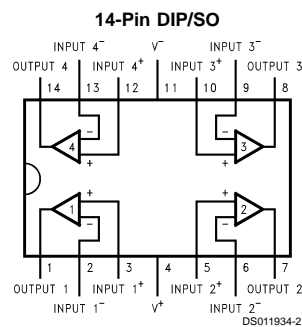

Order Number **LMC6574AIN**, **LMC6574BIN**,
LMC6574AIM or **LMC6574BIM**
See NS Package Number **N14A** or **M14A**

Ordering Information

| Package | Temperature Range Industrial, -40°C to +85°C | NSC Drawing | Transport Media |
|----------------------|---|-------------|--------------------|
| 8-Pin Molded DIP | LMC6572AIN, LMC6572BIN | N08E | Rail |
| 8-Pin Small Outline | LMC6572AIM, LMC6572BIM | M08A | Rail |
| | LMC6572AIMX, LMC6572BIMX | | Tape and Reel |
| 8-Pin Mini SO | LMC6572BIMM | MUA08A | Rail |
| | LMC6572BIMMX | | Tape and Reel |
| 14-Pin Molded DIP | LMC6574AIN, LMC6574BIN | N14A | Rail |
| 14-Pin Small Outline | LMC6574AIM, LMC6574BIM | M14A | Rail |
| | LMC6574AIMX, LMC6574BIMX | | Tape and Reel |

Absolute Maximum Ratings (Note 1)

If Military/Aerospace specified devices are required, please contact the National Semiconductor Sales Office/Distributors for availability and specifications.

| | |
|---|---|
| ESD Tolerance (Note 2) | 2000V |
| Differential Input Voltage | ±Supply Voltage |
| Voltage at Input/Output Pin | (V ⁺) +0.3V, (V ⁻) -0.3V |
| Supply Voltage (V ⁺ - V ⁻) | 12V |
| Current at Input Pin | ±5 mA |
| Current at Output Pin (Note 3) | ±10 mA |
| Current at Power Supply Pin | 35 mA |
| Lead Temperature (Soldering, 10 Seconds) | 260°C |
| Storage Temperature Range | -65°C to +150°C |

Junction Temperature (Note 4)

150°C

Operating Ratings (Note 1)

| | |
|---------------------------------------|--|
| Supply Voltage | 2.7V ≤ V ⁺ ≤ 11V |
| Junction Temperature Range | LMC6572AI, LMC6572BI LMC6574AI, LMC6574BI -40°C ≤ T _J ≤ +85°C |
| Thermal Resistance (θ _{JA}) | -40°C ≤ T _J ≤ +85°C |
| N Package, 8-Pin Molded DIP | 115°C/W |
| M Package, 8-Pin Surface Mount | 193°C/W |
| MSOP Package, 8-Pin Mini SO | 217°C/W |
| N Package, 14-Pin Molded DIP | 81°C/W |
| M Package, 14-Pin Surface Mount | 126°C/W |

2.7V DC Electrical Characteristics

Unless otherwise specified, all limits guaranteed for T_J = 25°C. V⁺ = 2.7V, V⁻ = 0V, V_{CM} = V_O = V⁺/2 and R_L > 1MΩ. **Bold-face** limits apply at the temperature extremes.

| Symbol | Parameter | Conditions | Typ (Note 5) | LMC6574AI | LMC6574BI | Units |
|-------------------|--|--|----------------------|--|--|-----------|
| | | | | LMC6572AI Limit (Note 6) | LMC6572BI Limit (Note 6) | |
| V _{OS} | Input Offset Voltage | V ⁺ = 2.7V and 3V | 0.5 | 3 3.5 | 7 7.5 | mV Max |
| TCV _{OS} | Input Offset Voltage Average Drift | | 1.5 | | | µV/°C |
| I _B | Input Current | | 0.02 | 10 | 10 | pA Max |
| I _{OS} | Input Offset Current | | 0.01 | 6 | 6 | pA Max |
| R _{IN} | Input Resistance | | >1 | | | Tera Ω |
| C _{IN} | Common-Mode Input Capacitance | | 3 | | | pF |
| CMRR | Common Mode Rejection Ratio | 0V ≤ V _{CM} ≤ 3.5V V ⁺ = 5V | 75 | 63 60 | 60 57 | dB Min |
| +PSRR | Positive Power Supply Rejection Ratio | 2.7V ≤ V ⁺ ≤ 5V, V ⁻ = 0V | 75 | 67 65 | 60 58 | dB Min |
| -PSRR | Negative Power Supply Rejection Ratio | -2.7V ≤ V ⁻ ≤ -5V, V ⁺ = 0V | 83 | 75 73 | 67 65 | dB Min |
| V _{CM} | Input Common-Mode Voltage Range | V ⁺ = 2.7V and 3V for CMRR ≥ 50 dB | -0.1 | -0.05 0 | -0.05 0 | V Max |
| | | | V ⁺ - 0.8 | V ⁺ - 1.0 V⁺ - 1.3 | V ⁺ - 1.0 V⁺ - 1.3 | V Min |
| A _V | Large Signal Voltage Gain | R _L = 100 kΩ (Note 7) | Sourcing | 1000 | | V/mV |
| | | | Sinking | 500 | | V/mV |

2.7V DC Electrical Characteristics (Continued)

Unless otherwise specified, all limits guaranteed for $T_J = 25^\circ\text{C}$, $V^+ = 2.7\text{V}$, $V^- = 0\text{V}$, $V_{\text{CM}} = V_O = V^+/2$ and $R_L > 1\text{M}\Omega$. **Bold-face** limits apply at the temperature extremes.

| Symbol | Parameter | Conditions | Typ (Note 5) | LMC6574AI | LMC6574BI | Units | |
|--|--|--|--|--------------------------------|--------------------------------|----------------------|----------------------|
| | | | | LMC6572AI Limit (Note 6) | LMC6572BI Limit (Note 6) | | |
| V_O | Output Swing | $V^+ = 2.7\text{V}$ $R_L = 100\text{ k}\Omega$ to $V^+/2$ | 2.695 | 2.68 2.66 | 2.65 2.62 | V Min | |
| | | | 0.005 | 0.03 0.05 | 0.06 0.09 | V Max | |
| | | $V^+ = 2.7\text{V}$ $R_L = 5\text{ k}\Omega$ to $V^+/2$ | 2.66 | 2.55 2.45 | 2.45 2.35 | V Min | |
| | | | 0.04 | 0.15 0.25 | 0.25 0.35 | V Max | |
| | | $V^+ = 3\text{V}$ $R_L = 100\text{ k}\Omega$ to $V^+/2$ | 2.995 | 2.98 2.96 | 2.95 2.93 | V Min | |
| | | | 0.005 | 0.03 0.05 | 0.06 0.09 | V Max | |
| | $V^+ = 3\text{V}$ $R_L = 5\text{ k}\Omega$ to $V^+/2$ | 2.96 | 2.85 2.75 | 2.75 2.65 | V Min | | |
| | | 0.04 | 0.15 0.25 | 0.25 0.35 | V Max | | |
| | I_{SC} | Output Short Circuit Current | Sourcing, $V_O = 0\text{V}$ | 6.0 | 4.0 3.0 | 3.0 2.0 | mA Min |
| | | | Sinking, $V_O = 2.7\text{V}$ | 4.0 | 3.0 2.0 | 2.5 1.5 | mA Min |
| | I_S | Supply Current | Quad Package $V^+ = +2.7\text{V}$, $V_O = V^+/2$ | 160 | 240 280 | 240 280 | μA Max |
| | | | Quad Package $V^+ = +3\text{V}$, $V_O = V^+/2$ | 160 | 240 280 | 240 280 | μA Max |
| Dual Package $V^+ = +2.7\text{V}$, $V_O = V^+/2$ | | | 80 | 120 140 | 120 140 | μA Max | |
| Dual Package $V^+ = +3\text{V}$, $V_O = V^+/2$ | | | 80 | 120 140 | 120 140 | μA Max | |

2.7V AC Electrical Characteristics

Unless otherwise specified, all limits guaranteed for $T_J = 25^\circ\text{C}$, $V^+ = 2.7\text{V}$, $V^- = 0\text{V}$, $V_{\text{CM}} = V_O = V^+/2$ and $R_L > 1\text{M}\Omega$. **Bold-face** limits apply at the temperature extremes.

| Symbol | Parameter | Conditions | Typ (Note 5) | LMC6574AI | LMC6574BI | Units |
|----------|---------------------------------|---|-----------------|--------------------------------|--------------------------------|------------------------------|
| | | | | LMC6572AI Limit (Note 6) | LMC6572BI Limit (Note 6) | |
| SR | Slew Rate | $V^+ = 2.7\text{V}$ and 3V (Note 8) | 90 | 30 10 | 30 10 | V/ms Min |
| | | | GBW | Gain-Bandwidth Product | $V^+ = 3\text{V}$ | 0.22 |
| ϕ_m | Phase Margin | | 60 | | | Deg |
| G_m | Gain Margin | | 12 | | | dB |
| | Amp-to-Amp Isolation | (Note 9) | 120 | | | dB |
| e_n | Input-Referred Voltage Noise | $F = 1\text{ kHz}$ $V_{\text{CM}} = 1\text{V}$ | 45 | | | $\text{nV}/\sqrt{\text{Hz}}$ |
| i_n | Input-Referred | $F = 1\text{ kHz}$ | 0.002 | | | $\text{pA}/\sqrt{\text{Hz}}$ |

2.7V AC Electrical Characteristics (Continued)

Unless otherwise specified, all limits guaranteed for $T_J = 25^\circ\text{C}$, $V^+ = 2.7\text{V}$, $V^- = 0\text{V}$, $V_{\text{CM}} = V_O = V^+/2$ and $R_L > 1\text{ M}\Omega$. **Bold-face** limits apply at the temperature extremes.

| Symbol | Parameter | Conditions | Typ (Note 5) | LMC6574AI LMC6572AI Limit (Note 6) | LMC6574BI LMC6572BI Limit (Note 6) | Units |
|--------|---------------------------|--|--------------|--|--|-------|
| | Current Noise | | | | | |
| T.H.D. | Total Harmonic Distortion | $F = 10\text{ kHz}$, $A_V = -2$ $R_L = 10\text{ k}\Omega$, $V_O = 1.0\text{ V}_{\text{PP}}$ | 0.05 | | | % |

Note 1: Absolute Maximum Ratings indicate limits beyond which damage to the device may occur. Operating Ratings indicate conditions for which the device is intended to be functional, but specific performance is not guaranteed. For guaranteed specifications and test conditions, see the Electrical Characteristics.

Note 2: Human body model, 1.5 k Ω in series with 100 pF.

Note 3: Applies to both single-supply and split-supply operation. Continuous short circuit operation at elevated ambient temperature can result in exceeding the maximum allowed junction temperature of 150°C.

Note 4: The maximum power dissipation is a function of $T_{\text{J(Max)}}$, θ_{JA} , and T_A . The maximum allowable power dissipation at any ambient temperature is $P_D = (T_{\text{J(Max)}} - T_A)/\theta_{\text{JA}}$. All numbers apply for packages soldered directly into a PC board.

Note 5: Typical values represent the most likely parametric norm.

Note 6: All limits are guaranteed by testing or statistical analysis.

Note 7: $V^+ = 3\text{V}$, $V_{\text{CM}} = 1.5\text{V}$ and R_L connected to 1.5V. For Sourcing tests, $1.5\text{V} \leq V_O \leq 2.5\text{V}$. For Sinking tests, $0.5\text{V} \leq V_O \leq 1.5\text{V}$.

Note 8: Connected as Voltage Follower with 1.0V step input. Number specified is the slower of the positive and negative slew rates.

Note 9: Input referred, $V^+ = 3\text{V}$ and $R_L = 100\text{ k}\Omega$ connected to 1.5V. Each amp excited in turn with 1 KHz to produce $V_O = 2\text{ V}_{\text{PP}}$.

Typical Performance Characteristics $V_S = +3\text{V}$, $T_A = 25^\circ\text{C}$, Unless otherwise specified

Supply Current vs Supply Voltage (Dual Package)

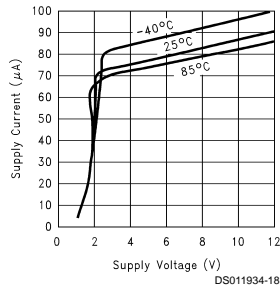

Input Current vs Temperature

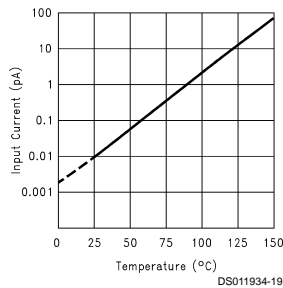

Sourcing Current vs Output Voltage

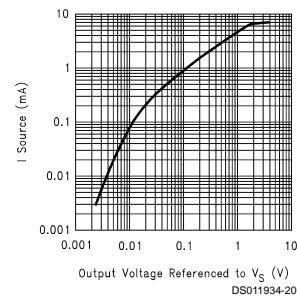

Sinking Current vs Output Voltage

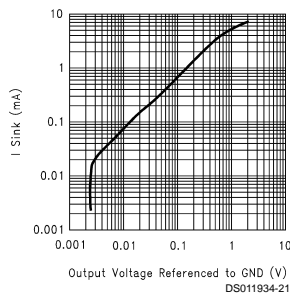

Output Voltage Swing vs Supply Voltage

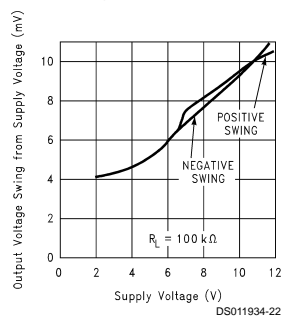

Input Voltage Noise vs Frequency

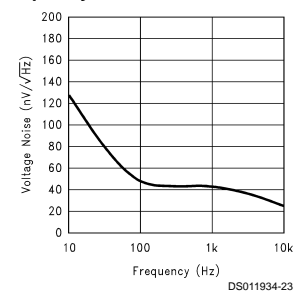

Typical Performance Characteristics $V_S = +3V$, $T_A = 25^\circ C$, Unless otherwise specified (Continued)

Crosstalk Rejection vs Frequency

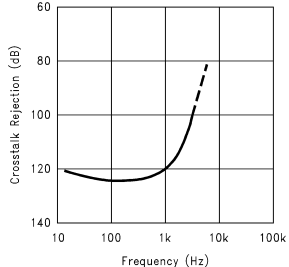

Positive PSRR vs Frequency

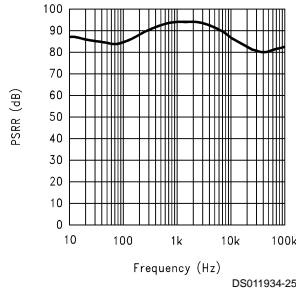

Negative PSRR vs Frequency

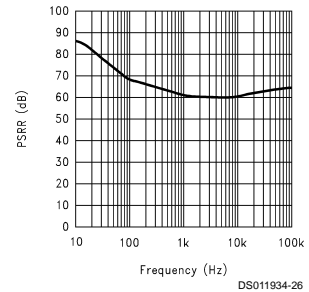

CMRR vs Frequency

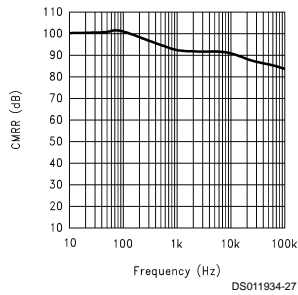

Input Voltage vs Output Voltage ($V_S = \pm 1.5$)

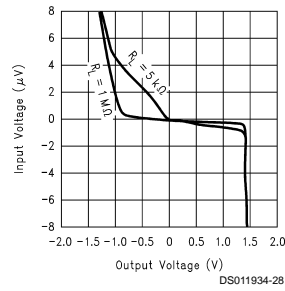

Open Loop Frequency Response

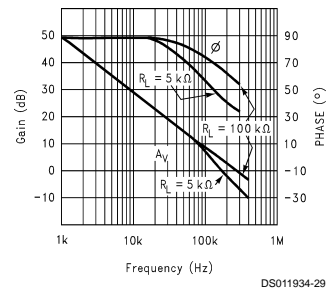

Open Loop Frequency Response vs Temperature

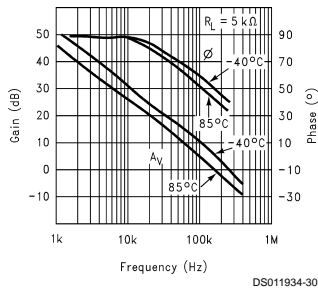

Maximum Output Swing vs Frequency

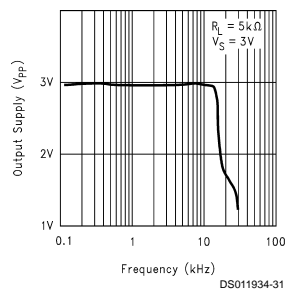

ZOUT vs Frequency

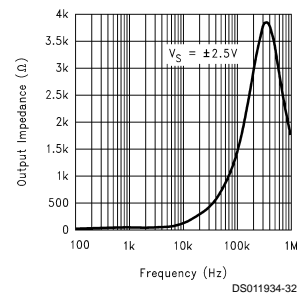

Typical Performance Characteristics $V_S = +3V$, $T_A = 25^\circ C$, Unless otherwise specified (Continued)

Slew Rate vs Supply Voltage

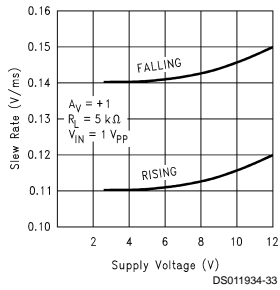

Non-Inverting Large Signal Pulse Response

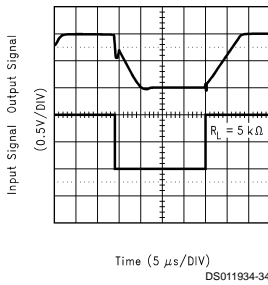

Non-Inverting Small Signal Pulse Response

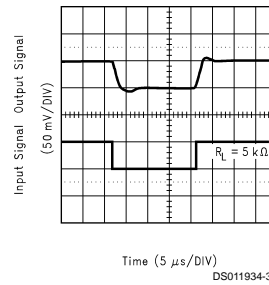

Inverting Large Signal Pulse Response

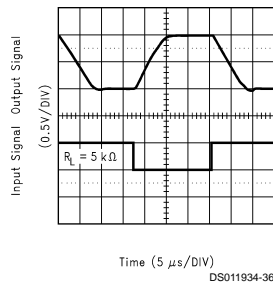

Inverting Small Signal Pulse Response

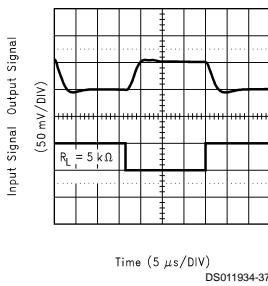

Stability vs Capacitive Load

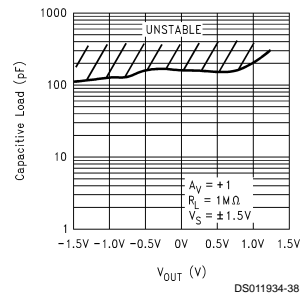

Stability vs Capacitive Load

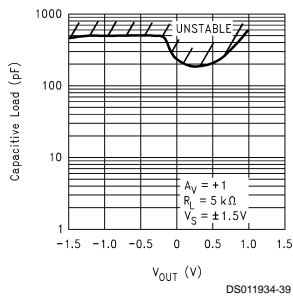

Stability vs Capacitive Load

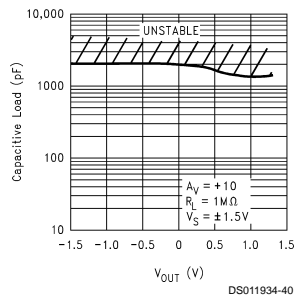

Stability vs Capacitive Load

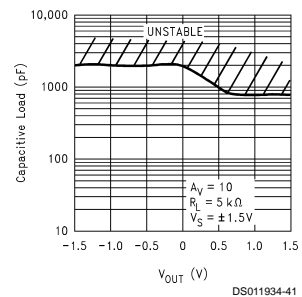

Typical Performance Characteristics $V_S = +3V$, $T_A = 25^\circ C$, Unless otherwise specified (Continued)

Bandwidth vs Capacitive Load

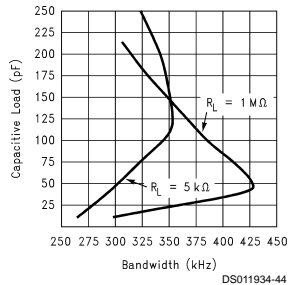

Capacitive Load vs Phase Margin

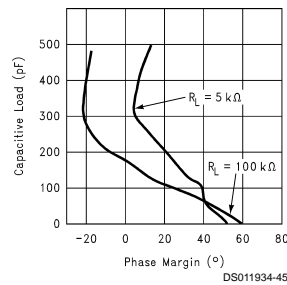

Capacitive Load vs Gain Margin

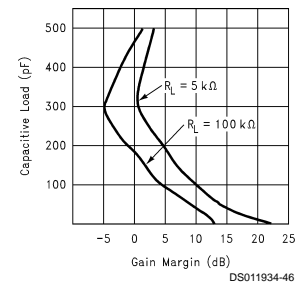

Applications Hints

1.0 LOW VOLTAGE AMPLIFIER TOPOLOGY

The LMC6574/2 incorporates a novel op-amp design topology that enables it to maintain rail-to-rail output swing even when driving a large load. Instead of relying on a push-pull unity gain output buffer stage, the output stage is taken directly from the internal integrator, which provides both low output impedance and large gain. Special feed-forward compensation design techniques are incorporated to maintain stability over a wider range of operating conditions than traditional micropower op-amps. These features make the LMC6574/2 both easier to design with, and provide higher speed than products typically found in this ultra-low power class.

2.0 COMPENSATING FOR INPUT CAPACITANCE

It is quite common to use large values of feedback resistance for amplifiers with ultra-low input current, like the LMC6574/2.

Although the LMC6574/2 is highly stable over a wide range of operating conditions, a large feedback resistor will react even with small values of capacitance at the input of the op-amp to reduce phase margin. The capacitance at the input of the op-amp comes from transducers, photodiodes and circuit board parasitics.

The effect of input capacitance can be compensated for by adding a capacitor, C_f , around the feedback resistors (as in Figure 1) such that:

$$\frac{1}{2\pi R_1 C_{IN}} \geq \frac{1}{2\pi R_2 C_f}$$

or

$$R_1 C_{IN} \leq R_2 C_f$$

Since it is often difficult to know the exact value of C_{IN} , C_f can be experimentally adjusted so that the desired pulse response is achieved. Refer to the LMC660 and LMC662 for a more detailed discussion on compensating for input capacitance.

When high input impedances are demanded, guarding of the LMC6574/2 is suggested. Guarding input lines will not only reduce leakage, but lowers stray input capacitance as well. (See *Printed-Circuit-Board Layout for High Impedance Work*).

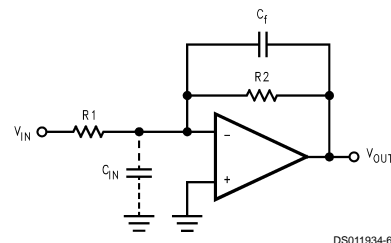

FIGURE 1. Cancelling the Effect of Input Capacitance

3.0 CAPACITIVE LOAD TOLERANCE

Direct capacitive loading will reduce the phase margin of many op-amps. A pole in the feedback loop is created by the combination of the op-amp's output impedance and the capacitive load. This pole induces phase lag at the unity-gain crossover frequency of the amplifier resulting in either an oscillatory or underdamped pulse response. With a few external components, op amps can easily indirectly drive capacitive loads, as shown in Figure 2.

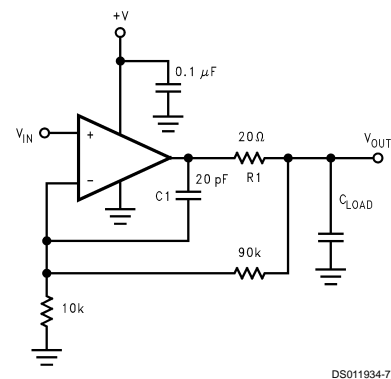

FIGURE 2. LMC6574/2 Noninverting Gain of 10 Amplifier, Compensated to Handle Capacitive Loads

In the circuit of Figure 2, R1 and C1 serve to counteract the loss of phase margin by feeding the high frequency compo-

Applications Hints (Continued)

ment of the output signal back to the amplifier's inverting input, thereby preserving phase margin in the overall feedback loop.

4.0 PRINTED-CIRCUIT-BOARD LAYOUT FOR HIGH-IMPEDANCE WORK

It is generally recognized that any circuit which must operate with less than 1000 pA of leakage current requires special layout of the PC board. When one wishes to take advantage of the ultra-low bias current of the LMC6574/2, typically less than 20 fA, it is essential to have an excellent layout. Fortunately, the techniques of obtaining low leakages are quite simple. First, the user must not ignore the surface leakage of the PC board, even though it may sometimes appear acceptably low, because under conditions of high humidity or dust or contamination, the surface leakage will be appreciable.

To minimize the effect of any surface leakage, lay out a ring of foil completely surrounding the LMC6574/2's inputs and the terminals of capacitors, diodes, conductors, resistors, relay terminals, etc. connected to the op-amp's inputs, as in *Figure 3*. To have a significant effect, guard rings should be placed on both the top and bottom of the PC board. This PC foil must then be connected to a voltage which is at the same voltage as the amplifier inputs, since no leakage current can flow between two points at the same potential. For example, a PC board trace-to-pad resistance of $10^{12}\Omega$, which is normally considered a very large resistance, could leak 5 pA if the trace were a 5V bus adjacent to the pad of the input. This would cause a 250 times degradation from the LMC6574/2's actual performance. However, if a guard ring is held within 5 mV of the inputs, then even a resistance of $10^{11}\Omega$ would cause only 0.05 pA of leakage current. See *Figure 4* for typical connections of guard rings for standard op-amp configurations.

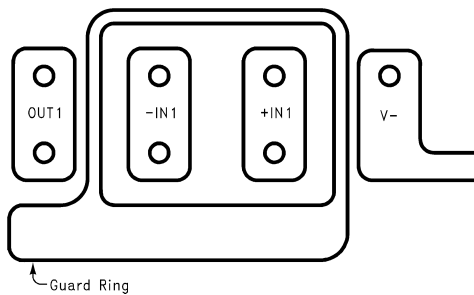

FIGURE 3. Example of Guard Ring in P.C. Board Layout

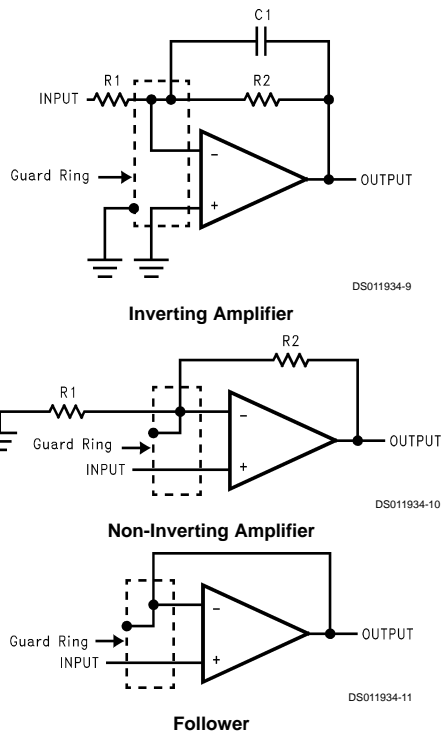
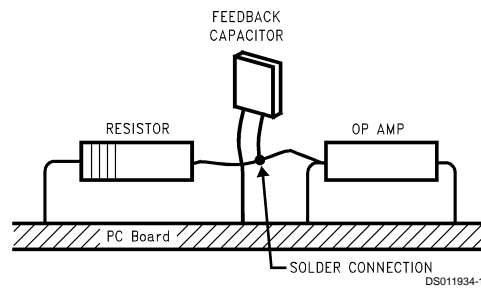

FIGURE 4. Typical Connections of Guard Rings

The designer should be aware that when it is inappropriate to lay out a PC board for the sake of just a few circuits, there is another technique which is even better than a guard ring on a PC board: Don't insert the amplifier's input pin into the board at all, but bend it up in the air and use only air as an insulator. Air is an excellent insulator. In this case you may have to forego some of the advantages of PC board construction, but the advantages are sometimes well worth the effort of using point-to-point up-in-the-air wiring. See *Figure 5*.



(Input pins are lifted out of PC board and soldered directly to components. All other pins connected to PC board).

FIGURE 5. Air Wiring

Applications Hints (Continued)

5.0 SPICE MACROMODEL

A spice macromodel is available for the LMC6574/2. This model includes accurate simulation of:

- input common-mode voltage range
- frequency and transient response
- GBW dependence on loading conditions
- quiescent and dynamic supply current
- output swing dependence on loading conditions

and many more characteristics as listed on the macromodel disk.

Contact your local National Semiconductor sales office to obtain an operational amplifier spice model library disk.

Typical Single-Supply Applications

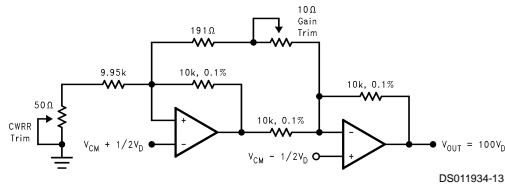

FIGURE 6. Low-Power Two-Op-Amp Instrumentation Amplifier

DS011934-13

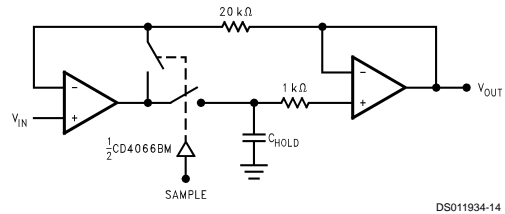
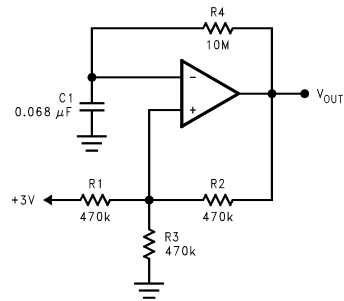

FIGURE 7. Sample and Hold

DS011934-14



DS011934-15

FIGURE 8. 1 Hz Square Wave Oscillator

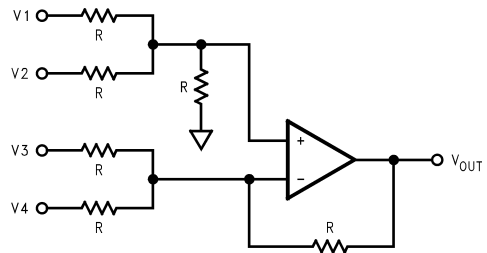

$$V_{OUT} = V1 + V2 - V3 - V4$$

DS011934-16

FIGURE 9. Adder/Subtractor Circuit

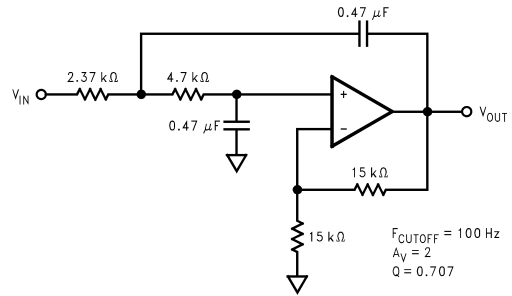

$$F_{CUTOFF} = 100 \text{ Hz}$$

$$A_V = 2$$

$$Q = 0.707$$

DS011934-17

FIGURE 10. Low Pass Filter

Physical Dimensions inches (millimeters) unless otherwise noted

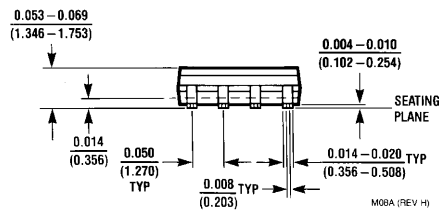
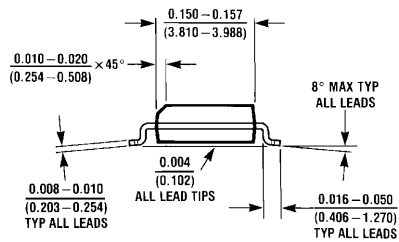
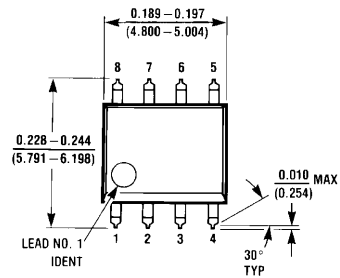

8-Pin Small Outline Package
Order Package Number LMC6572AIM or LMC6572BIM
NS Package Number M08A

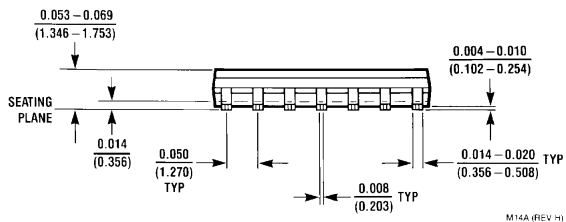
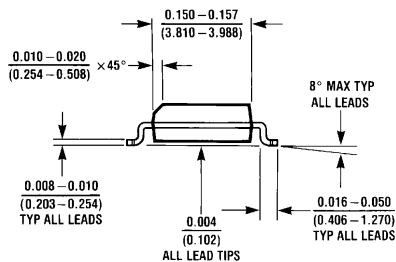
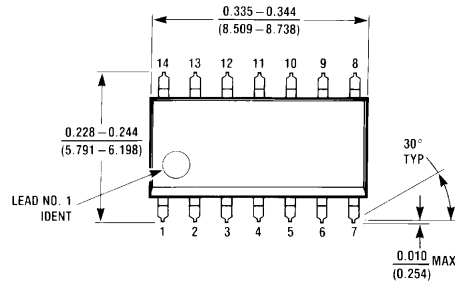

14-Pin Small Outline Package
Order Package Number LMC6574AIM or LMC6574BIM
NS Package Number M14A

Physical Dimensions inches (millimeters) unless otherwise noted (Continued)

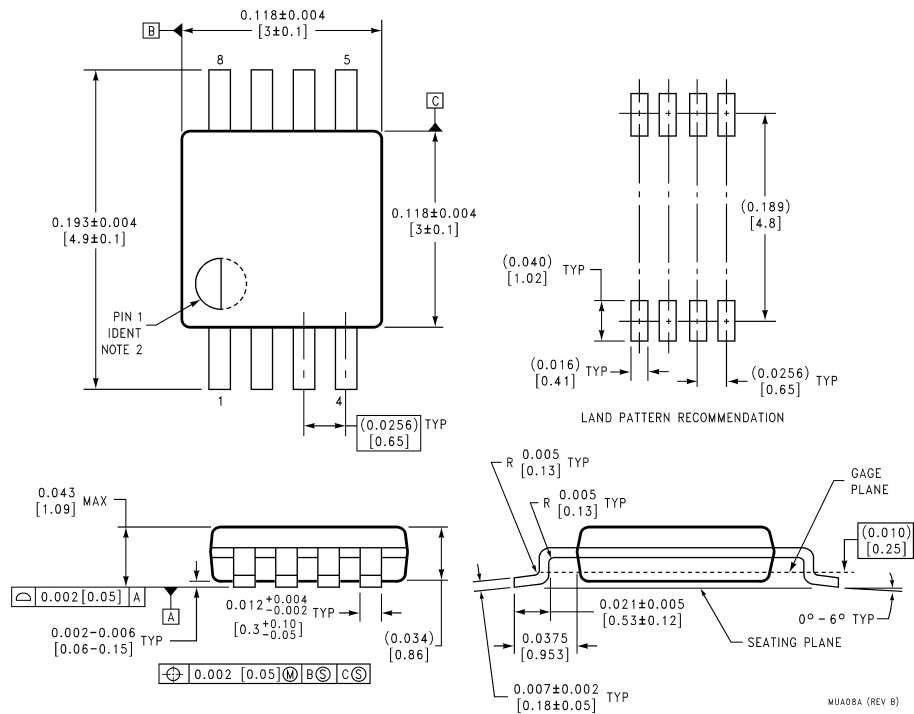

8-Lead Mini-Small Outline Molded Package, JEDEC
Order Number LMC6572BIMM or LMC6572BIMMX
NS Package Number MUA08A

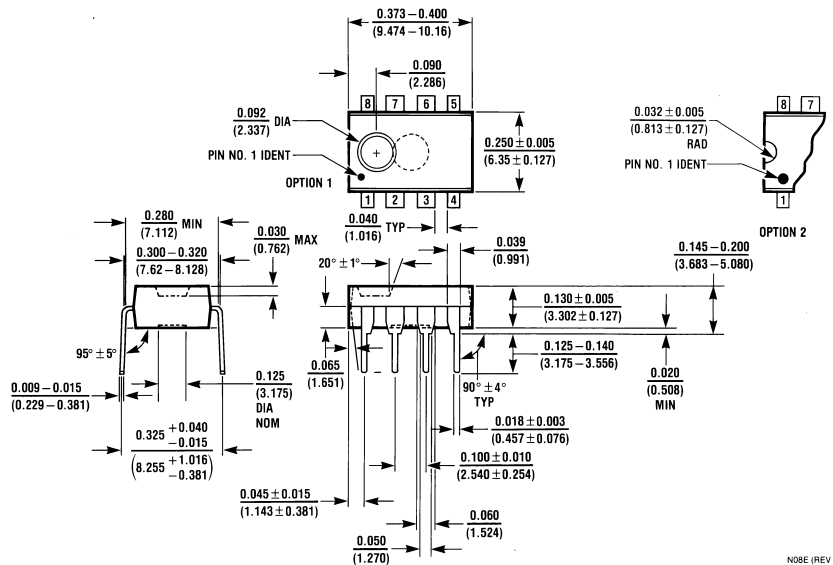

8-Pin Molded Dual-In-Line Package
Order Number LMC6572AIN or LMC6572BIN
NS Package Number NO8E

Physical Dimensions inches (millimeters) unless otherwise noted (Continued)

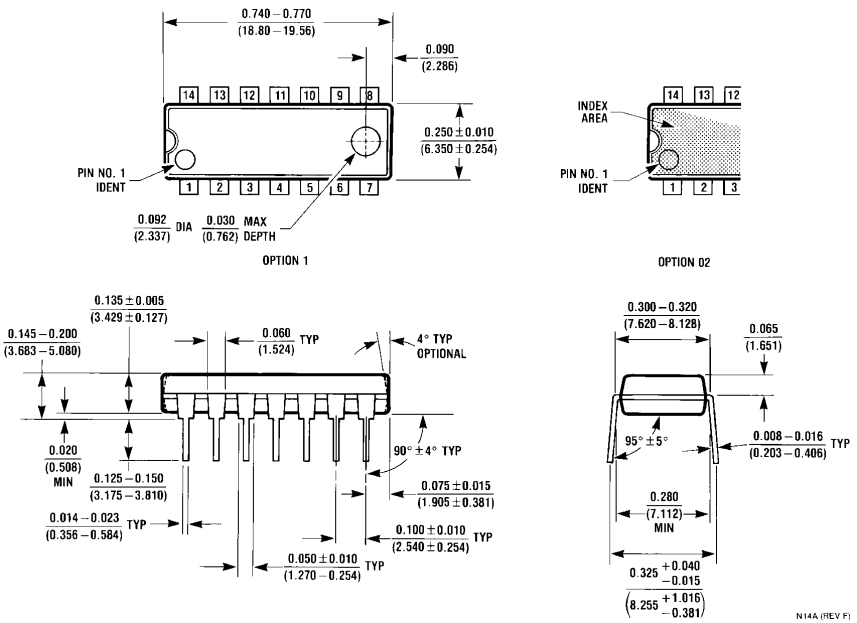

14-Pin Molded Dual-In-Line Package
Order Number LMC6574AIN or LMC6574BIN
NS Package Number N14A

LIFE SUPPORT POLICY

NATIONAL'S PRODUCTS ARE NOT AUTHORIZED FOR USE AS CRITICAL COMPONENTS IN LIFE SUPPORT DEVICES OR SYSTEMS WITHOUT THE EXPRESS WRITTEN APPROVAL OF THE PRESIDENT AND GENERAL COUNSEL OF NATIONAL SEMICONDUCTOR CORPORATION. As used herein:

1. Life support devices or systems are devices or systems which, (a) are intended for surgical implant into the body, or (b) support or sustain life, and whose failure to perform when properly used in accordance with instructions for use provided in the labeling, can be reasonably expected to result in a significant injury to the user.
2. A critical component is any component of a life support device or system whose failure to perform can be reasonably expected to cause the failure of the life support device or system, or to affect its safety or effectiveness.

| | | | |
|--|---|---|---|
|  <p>National Semiconductor Corporation Americas Tel: 1-800-272-9959 Fax: 1-800-737-7018 Email: support@nsc.com www.national.com</p> | <p>National Semiconductor Europe Fax: +49 (0) 1 80-530 85 86 Email: europe.support@nsc.com Deutsch Tel: +49 (0) 1 80-530 85 85 English Tel: +49 (0) 1 80-532 78 32 Français Tel: +49 (0) 1 80-532 93 58 Italiano Tel: +49 (0) 1 80-534 16 80</p> | <p>National Semiconductor Asia Pacific Customer Response Group Tel: 65-2544466 Fax: 65-2504466 Email: sea.support@nsc.com</p> | <p>National Semiconductor Japan Ltd. Tel: 81-3-5639-7560 Fax: 81-3-5639-7507</p> |
|--|---|---|---|

National does not assume any responsibility for use of any circuitry described, no circuit patent licenses are implied and National reserves the right at any time without notice to change said circuitry and specifications.