

LMH6642EP/LMH6643EP/LMH6644EP

Enhanced Plastic Low Power, 130MHz, 75mA Rail-to-Rail Output Amplifiers

General Description

The LMH664XEP family true single supply voltage feedback amplifiers offer high speed (130MHz), low distortion (–62dBc), and exceptionally high output current (approximately 75mA) at low cost and with reduced power consumption when compared against existing devices with similar performance.

Input common mode voltage range extends to 0.5V below V^- and 1V from V^+ . Output voltage range extends to within 40mV of either supply rail, allowing wide dynamic range especially desirable in low voltage applications. The output stage is capable of approximately 75mA in order to drive heavy loads. Fast output Slew Rate (130V/ μ s) ensures large peak-to-peak output swings can be maintained even at higher speeds, resulting in exceptional full power bandwidth of 40MHz with a 3V supply. These characteristics, along with low cost, are ideal features for a multitude of industrial and commercial applications.

Careful attention has been paid to ensure device stability under all operating voltages and modes. The result is a very well behaved frequency response characteristic (0.1dB gain flatness up the 12MHz under 150 Ω load and $A_V = +2$) with minimal peaking (typically 2dB maximum) for any gain setting and under both heavy and light loads. This along with fast settling time (68ns) and low distortion allows the device to operate well in ADC buffer, and high frequency filter applications as well as other applications.

This device family offers professional quality video performance with low DG (0.01%) and DP (0.01°) characteristics. Differential Gain and Differential Phase characteristics are also well maintained under heavy loads (150 Ω) and throughout the output voltage range. The LMH664XEP family is offered in single (LMH6642EP), dual (LMH6643EP), and quad (LMH6644EP) options. See ordering information for packages offered.

ENHANCED PLASTIC

- Extended Temperature Performance of –40°C to +85°C
- Baseline Control - Single Fab & Assembly Site
- Process Change Notification (PCN)
- Qualification & Reliability Data
- Solder (PbSn) Lead Finish is standard
- Enhanced Diminishing Manufacturing Sources (DMS) Support

Features

($V_S = \pm 5V$, $T_A = 25^\circ C$, $R_L = 2k\Omega$, $A_V = +1$. Typical values unless specified).

- –3dB BW ($A_V = +1$) 130MHz
- Supply voltage range 2.7V to 12.8V
- Slew rate (Note 11), ($A_V = -1$) 130V/ μ s
- Supply current (no load) 2.7mA/amp
- Output short circuit current +115mA/–145mA
- Linear output current $\pm 75mA$
- Input common mode volt. 0.5V beyond V^- , 1V from V^+
- Output voltage swing 40mV from rails
- Input voltage noise (100kHz) 17nV/ \sqrt{Hz}
- Input current noise (100kHz) 0.9pA/ \sqrt{Hz}
- THD (5MHz, $R_L = 2k\Omega$, $V_O = 2V_{PP}$, $A_V = +2$) –62dBc
- Settling time 68ns
- Fully characterized for 3V, 5V, and $\pm 5V$
- Overdrive recovery 100ns
- Output short circuit protected (Note 14)
- No output phase reversal with CMVR exceeded

Applications

- Selected Military Applications
- Selected Avionics Applications

Ordering Information

PART NUMBER	VID PART NUMBER	NS PACKAGE NUMBER (Note 3)
LMH6642MFXEP	V62/04625-01	MF05A
LMH6643MAXEP	V62/04625-02	M08A
LMH6644MAXEP	V62/04625-03	M14A
(Notes 1, 2)	TBD	TBD

Note 1: For the following (Enhanced Plastic) versions, check for availability: LMH6642MAEP, LMH6642MAXEP, LMH6642MFEP, LMH6643MAEP, LMH6643MMEP, LMH6643MMXEP, LMH6644MAEP, LMH6644MTEP, LMH6644MTXEP. Parts listed with an "X" are provided in Tape & Reel and parts without an "X" are in Rails.

Note 2: FOR ADDITIONAL ORDERING AND PRODUCT INFORMATION, PLEASE VISIT THE ENHANCED PLASTIC WEB SITE AT: www.national.com/mil

Note 3: Refer to package details under Physical Dimensions

Absolute Maximum Ratings (Note 4)

If Military/Aerospace specified devices are required, please contact the National Semiconductor Sales Office/Distributors for availability and specifications.

ESD Tolerance	2KV (Note 5)
	200V (Note 12)
V_{IN} Differential	$\pm 2.5V$
Output Short Circuit Duration	(Note 6), (Note 14)
Supply Voltage ($V^+ - V^-$)	13.5V
Voltage at Input/Output pins	$V^+ +0.8V, V^- -0.8V$
Input Current	$\pm 10mA$
Storage Temperature Range	$-65^\circ C$ to $+150^\circ C$
Junction Temperature (Note 7)	$+150^\circ C$
Soldering Information	

Infrared or Convection Reflow(20 sec)	$235^\circ C$
Wave Soldering Lead Temp.(10 sec)	$260^\circ C$

Operating Ratings (Note 4)

Supply Voltage ($V^+ - V^-$)	2.7V to 12.8V
Junction Temperature Range (Note 7)	$-40^\circ C$ to $+85^\circ C$
Package Thermal Resistance (Note 7) (θ_{JA})	
SOT23-5	$265^\circ C/W$
SOIC-8	$190^\circ C/W$
MSOP-8	$235^\circ C/W$
SOIC-14	$145^\circ C/W$
TSSOP-14	$155^\circ C/W$

3V Electrical Characteristics

Unless otherwise specified, all limits guaranteed for at $T_J = 25^\circ C$, $V^+ = 3V$, $V^- = 0V$, $V_{CM} = V_O = V^+/2$, and $R_L = 2k\Omega$ to $V^+/2$. **Boldface** limits apply at the temperature extremes.

Symbol	Parameter	Conditions	Min (Note 9)	Typ (Note 8)	Max (Note 9)	Units
BW	-3dB BW	$A_V = +1, V_{OUT} = 200mV_{PP}$	80	115		MHz
		$A_V = +2, -1, V_{OUT} = 200mV_{PP}$		46		
$BW_{0.1dB}$	0.1dB Gain Flatness	$A_V = +2, R_L = 150\Omega$ to $V^+/2$, $R_L = 402\Omega, V_{OUT} = 200mV_{PP}$		19		MHz
PBW	Full Power Bandwidth	$A_V = +1, -1dB, V_{OUT} = 1V_{PP}$		40		MHz
e_n	Input-Referred Voltage Noise	$f = 100kHz$		17		nV/\sqrt{Hz}
		$f = 1kHz$		48		
i_n	Input-Referred Current Noise	$f = 100kHz$		0.90		pA/\sqrt{Hz}
		$f = 1kHz$		3.3		
THD	Total Harmonic Distortion	$f = 5MHz, V_O = 2V_{PP}, A_V = -1,$ $R_L = 100\Omega$ to $V^+/2$		-48		dBc
DG	Differential Gain	$V_{CM} = 1V, NTSC, A_V = +2$ $R_L = 150\Omega$ to $V^+/2$		0.17		%
		$R_L = 1k\Omega$ to $V^+/2$		0.03		
DP	Differential Phase	$V_{CM} = 1V, NTSC, A_V = +2$ $R_L = 150\Omega$ to $V^+/2$		0.05		deg
		$R_L = 1k\Omega$ to $V^+/2$		0.03		
CT Rej.	Cross-Talk Rejection	$f = 5MHz, Receiver:$ $R_f = R_g = 510\Omega, A_V = +2$		47		dB
T_S	Settling Time	$V_O = 2V_{PP}, \pm 0.1\%, 8pF$ Load, $V_S = 5V$		68		ns
SR	Slew Rate (Note 11)	$A_V = -1, V_I = 2V_{PP}$	90	120		$V/\mu s$
V_{OS}	Input Offset Voltage			± 1	± 5 ± 7	mV
TC V_{OS}	Input Offset Average Drift	(Note 15)		± 5		$\mu V/^\circ C$
I_B	Input Bias Current	(Note 10)		-1.50	-2.60 -3.25	μA
I_{OS}	Input Offset Current			20	800 1000	nA
R_{IN}	Common Mode Input Resistance			3		$M\Omega$
C_{IN}	Common Mode Input Capacitance			2		pF

3V Electrical Characteristics (Continued)

Unless otherwise specified, all limits guaranteed for at $T_J = 25^\circ\text{C}$, $V^+ = 3\text{V}$, $V^- = 0\text{V}$, $V_{\text{CM}} = V_O = V^+/2$, and $R_L = 2\text{k}\Omega$ to $V^+/2$.

Boldface limits apply at the temperature extremes.

Symbol	Parameter	Conditions	Min (Note 9)	Typ (Note 8)	Max (Note 9)	Units
CMVR	Input Common-Mode Voltage Range	CMRR $\geq 50\text{dB}$		-0.5	-0.2	V
			1.8 1.6	2.0	-0.1	
CMRR	Common Mode Rejection Ratio	V_{CM} Stepped from 0V to 1.5V	72	95		dB
A_{VOL}	Large Signal Voltage Gain	$V_O = 0.5\text{V}$ to 2.5V $R_L = 2\text{k}\Omega$ to $V^+/2$	80 75	96		dB
		$V_O = 0.5\text{V}$ to 2.5V $R_L = 150\Omega$ to $V^+/2$	74 70	82		
V_O	Output Swing High	$R_L = 2\text{k}\Omega$ to $V^+/2$, $V_{\text{ID}} = 200\text{mV}$	2.90	2.98		V
		$R_L = 150\Omega$ to $V^+/2$, $V_{\text{ID}} = 200\text{mV}$	2.80	2.93		
	Output Swing Low	$R_L = 2\text{k}\Omega$ to $V^+/2$, $V_{\text{ID}} = -200\text{mV}$		25	75	mV
		$R_L = 150\Omega$ to $V^+/2$, $V_{\text{ID}} = -200\text{mV}$		75	150	
I_{SC}	Output Short Circuit Current	Sourcing to $V^+/2$ $V_{\text{ID}} = 200\text{mV}$ (Note 13)	50 35	95		mA
		Sinking to $V^+/2$ $V_{\text{ID}} = -200\text{mV}$ (Note 13)	55 40	110		
I_{OUT}	Output Current	$V_{\text{OUT}} = 0.5\text{V}$ from either supply		± 65		mA
+PSRR	Positive Power Supply Rejection Ratio	$V^+ = 3.0\text{V}$ to 3.5V, $V_{\text{CM}} = 1.5\text{V}$	75	85		dB
I_S	Supply Current (per channel)	No Load		2.70	4.00 4.50	mA

5V Electrical Characteristics

Unless otherwise specified, all limits guaranteed for at $T_J = 25^\circ\text{C}$, $V^+ = 5\text{V}$, $V^- = 0\text{V}$, $V_{\text{CM}} = V_O = V^+/2$, and $R_L = 2\text{k}\Omega$ to $V^+/2$.

Boldface limits apply at the temperature extremes.

Symbol	Parameter	Conditions	Min (Note 9)	Typ (Note 8)	Max (Note 9)	Units
BW	-3dB BW	$A_V = +1$, $V_{\text{OUT}} = 200\text{mV}_{\text{PP}}$	90	120		MHz
		$A_V = +2, -1$, $V_{\text{OUT}} = 200\text{mV}_{\text{PP}}$		46		
$BW_{0.1\text{dB}}$	0.1dB Gain Flatness	$A_V = +2$, $R_L = 150\Omega$ to $V^+/2$, $R_f = 402\Omega$, $V_{\text{OUT}} = 200\text{mV}_{\text{PP}}$		15		MHz
PBW	Full Power Bandwidth	$A_V = +1$, -1dB, $V_{\text{OUT}} = 2V_{\text{PP}}$		22		MHz
e_n	Input-Referred Voltage Noise	$f = 100\text{kHz}$		17		$\text{nV}/\sqrt{\text{Hz}}$
		$f = 1\text{kHz}$		48		
i_n	Input-Referred Current Noise	$f = 100\text{kHz}$		0.90		$\text{pA}/\sqrt{\text{Hz}}$
		$f = 1\text{kHz}$		3.3		
THD	Total Harmonic Distortion	$f = 5\text{MHz}$, $V_O = 2V_{\text{PP}}$, $A_V = +2$		-60		dBc
DG	Differential Gain	NTSC, $A_V = +2$ $R_L = 150\Omega$ to $V^+/2$		0.16		%
		$R_L = 1\text{k}\Omega$ to $V^+/2$		0.05		
DP	Differential Phase	NTSC, $A_V = +2$ $R_L = 150\Omega$ to $V^+/2$		0.05		deg
		$R_L = 1\text{k}\Omega$ to $V^+/2$		0.01		
CT Rej.	Cross-Talk Rejection	$f = 5\text{MHz}$, Receiver: $R_f = R_g = 510\Omega$, $A_V = +2$		47		dB
T_S	Settling Time	$V_O = 2V_{\text{PP}}$, $\pm 0.1\%$, 8pF Load		68		ns

5V Electrical Characteristics (Continued)

Unless otherwise specified, all limits guaranteed for at $T_J = 25^\circ\text{C}$, $V^+ = 5\text{V}$, $V^- = 0\text{V}$, $V_{\text{CM}} = V_O = V^+/2$, and $R_L = 2\text{k}\Omega$ to $V^+/2$. **Boldface** limits apply at the temperature extremes.

Symbol	Parameter	Conditions	Min (Note 9)	Typ (Note 8)	Max (Note 9)	Units
SR	Slew Rate (Note 11)	$A_V = -1$, $V_I = 2V_{\text{PP}}$	95	125		V/ μs
V_{OS}	Input Offset Voltage			± 1	± 5 ± 7	mV
TC V_{OS}	Input Offset Average Drift	(Note 15)		± 5		$\mu\text{V}/^\circ\text{C}$
I_{B}	Input Bias Current	(Note 10)		-1.70	-2.60 -3.25	μA
I_{OS}	Input Offset Current			20	800 1000	nA
R_{IN}	Common Mode Input Resistance			3		M Ω
C_{IN}	Common Mode Input Capacitance			2		pF
CMVR	Input Common-Mode Voltage Range	CMRR $\geq 50\text{dB}$		-0.5	-0.2 -0.1	V
			3.8 3.6	4.0		
CMRR	Common Mode Rejection Ratio	V_{CM} Stepped from 0V to 3.5V	72	95		dB
A_{VOL}	Large Signal Voltage Gain	$V_O = 0.5\text{V}$ to 4.50V $R_L = 2\text{k}\Omega$ to $V^+/2$	86 82	98		dB
		$V_O = 0.5\text{V}$ to 4.25V $R_L = 150\Omega$ to $V^+/2$	76 72	82		
V_O	Output Swing High	$R_L = 2\text{k}\Omega$ to $V^+/2$, $V_{\text{ID}} = 200\text{mV}$	4.90	4.98		V
		$R_L = 150\Omega$ to $V^+/2$, $V_{\text{ID}} = 200\text{mV}$	4.65	4.90		
V_O	Output Swing Low	$R_L = 2\text{k}\Omega$ to $V^+/2$, $V_{\text{ID}} = -200\text{mV}$		25	100	mV
		$R_L = 150\Omega$ to $V^+/2$, $V_{\text{ID}} = -200\text{mV}$		100	150	
I_{SC}	Output Short Circuit Current	Sourcing to $V^+/2$ $V_{\text{ID}} = 200\text{mV}$ (Note 13)	55 40	115		mA
		Sinking to $V^+/2$ $V_{\text{ID}} = -200\text{mV}$ (Note 13)	70 55	140		
I_{OUT}	Output Current	$V_O = 0.5\text{V}$ from either supply		± 70		mA
+PSRR	Positive Power Supply Rejection Ratio	$V^+ = 4.0\text{V}$ to 6V	79	90		dB
I_{S}	Supply Current (per channel)	No Load		2.70	4.25 5.00	mA

 $\pm 5\text{V}$ Electrical Characteristics

Unless otherwise specified, all limits guaranteed for at $T_J = 25^\circ\text{C}$, $V^+ = 5\text{V}$, $V^- = -5\text{V}$, $V_{\text{CM}} = V_O = 0\text{V}$ and $R_L = 2\text{k}\Omega$ to ground. **Boldface** limits apply at the temperature extremes.

Symbol	Parameter	Conditions	Min (Note 9)	Typ (Note 8)	Max (Note 9)	Units
BW	-3dB BW	$A_V = +1$, $V_{\text{OUT}} = 200\text{mV}_{\text{PP}}$	95	130		MHz
		$A_V = +2$, -1, $V_{\text{OUT}} = 200\text{mV}_{\text{PP}}$		46		
$BW_{0.1\text{dB}}$	0.1dB Gain Flatness	$A_V = +2$, $R_L = 150\Omega$ to $V^+/2$, $R_f = 806\Omega$, $V_{\text{OUT}} = 200\text{mV}_{\text{PP}}$		12		MHz
PBW	Full Power Bandwidth	$A_V = +1$, -1dB, $V_{\text{OUT}} = 2V_{\text{PP}}$		24		MHz
e_n	Input-Referred Voltage Noise	$f = 100\text{kHz}$		17		nV/ $\sqrt{\text{Hz}}$
		$f = 1\text{kHz}$		48		

±5V Electrical Characteristics (Continued)

Unless otherwise specified, all limits guaranteed for at $T_J = 25^\circ\text{C}$, $V^+ = 5\text{V}$, $V^- = -5\text{V}$, $V_{CM} = V_O = 0\text{V}$ and $R_L = 2\text{k}\Omega$ to ground. **Boldface** limits apply at the temperature extremes.

Symbol	Parameter	Conditions	Min (Note 9)	Typ (Note 8)	Max (Note 9)	Units
i_n	Input-Referred Current Noise	$f = 100\text{kHz}$		0.90		$\text{pA}/\sqrt{\text{Hz}}$
		$f = 1\text{kHz}$		3.3		
THD	Total Harmonic Distortion	$f = 5\text{MHz}$, $V_O = 2V_{PP}$, $A_V = +2$		-62		dBc
DG	Differential Gain	NTSC, $A_V = +2$ $R_L = 150\Omega$ to $V^+/2$		0.15		%
		$R_L = 1\text{k}\Omega$ to $V^+/2$		0.01		
DP	Differential Phase	NTSC, $A_V = +2$ $R_L = 150\Omega$ to $V^+/2$		0.04		deg
		$R_L = 1\text{k}\Omega$ to $V^+/2$		0.01		
CT Rej.	Cross-Talk Rejection	$f = 5\text{MHz}$, Receiver: $R_f = R_g = 510\Omega$, $A_V = +2$		47		dB
T_S	Settling Time	$V_O = 2V_{PP}$, $\pm 0.1\%$, 8pF Load, $V_S = 5\text{V}$		68		ns
SR	Slew Rate (Note 11)	$A_V = -1$, $V_I = 2V_{PP}$	100	135		$\text{V}/\mu\text{s}$
V_{OS}	Input Offset Voltage			± 1	± 5 ± 7	mV
TC V_{OS}	Input Offset Average Drift	(Note 15)		± 5		$\mu\text{V}/^\circ\text{C}$
I_B	Input Bias Current	(Note 10)		-1.60	-2.60 -3.25	μA
I_{OS}	Input Offset Current			20	800 1000	nA
R_{IN}	Common Mode Input Resistance			3		$\text{M}\Omega$
C_{IN}	Common Mode Input Capacitance			2		pF
CMVR	Input Common-Mode Voltage Range	CMRR $\geq 50\text{dB}$		-5.5	-5.2 -5.1	V
			3.8 3.6	4.0		
CMRR	Common Mode Rejection Ratio	V_{CM} Stepped from -5V to 3.5V	74	95		dB
A_{VOL}	Large Signal Voltage Gain	$V_O = -4.5\text{V}$ to 4.5V , $R_L = 2\text{k}\Omega$	88 84	96		dB
		$V_O = -4.0\text{V}$ to 4.0V , $R_L = 150\Omega$	78 74	82		
V_O	Output Swing High	$R_L = 2\text{k}\Omega$, $V_{ID} = 200\text{mV}$	4.90	4.96		V
		$R_L = 150\Omega$, $V_{ID} = 200\text{mV}$	4.65	4.80		
V_O	Output Swing Low	$R_L = 2\text{k}\Omega$, $V_{ID} = -200\text{mV}$		-4.96	-4.90	V
		$R_L = 150\Omega$, $V_{ID} = -200\text{mV}$		-4.80	-4.65	
I_{SC}	Output Short Circuit Current	Sourcing to Ground $V_{ID} = 200\text{mV}$ (Note 13)	60 35	115		mA
		Sinking to Ground $V_{ID} = -200\text{mV}$ (Note 13)	85 65	145		
I_{OUT}	Output Current	$V_O = 0.5\text{V}$ from either supply	± 75			mA
PSRR	Power Supply Rejection Ratio	$(V^+, V^-) = (4.5\text{V}, -4.5\text{V})$ to $(5.5\text{V}, -5.5\text{V})$	78	90		dB
I_S	Supply Current (per channel)	No Load		2.70	4.50 5.50	mA

±5V Electrical Characteristics (Continued)

Note 4: Absolute Maximum Ratings indicate limits beyond which damage to the device may occur. Operating Ratings indicate conditions for which the device is intended to be functional, but specific performance is not guaranteed. For guaranteed specifications and the test conditions, see the Electrical Characteristics.

Note 5: Human body model, 1.5kΩ in series with 100pF.

Note 6: Applies to both single-supply and split-supply operation. Continuous short circuit operation at elevated ambient temperature can result in exceeding the maximum allowed junction temperature of 150°C.

Note 7: The maximum power dissipation is a function of $T_{J(MAX)}$, θ_{JA} , and T_A . The maximum allowable power dissipation at any ambient temperature is $P_D = (T_{J(MAX)} - T_A) / \theta_{JA}$. All numbers apply for packages soldered directly onto a PC board.

Note 8: Typical values represent the most likely parametric norm.

Note 9: All limits are guaranteed by testing or statistical analysis.

Note 10: Positive current corresponds to current flowing into the device.

Note 11: Slew rate is the average of the rising and falling slew rates.

Note 12: Machine Model, 0Ω in series with 200pF.

Note 13: Short circuit test is a momentary test. See Note 14.

Note 14: Output short circuit duration is infinite for $V_S < 6V$ at room temperature and below. For $V_S > 6V$, allowable short circuit duration is 1.5ms.

Note 15: Offset voltage average drift determined by dividing the change in V_{OS} at temperature extremes by the total temperature change.

Connection Diagrams

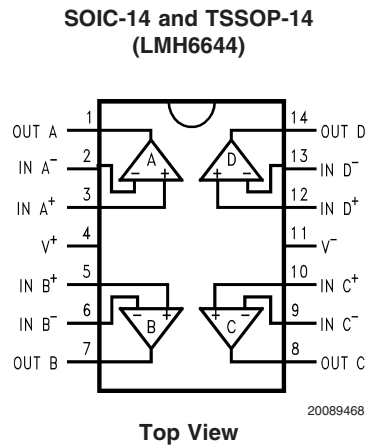
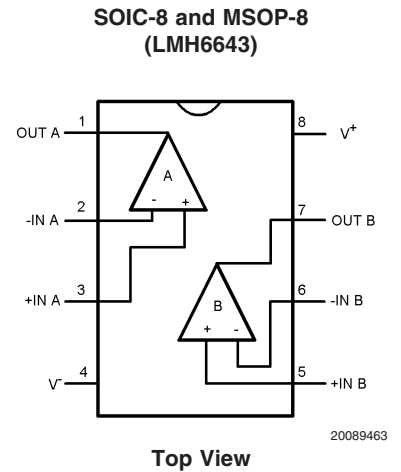
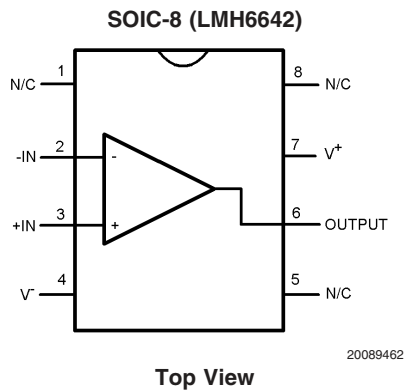
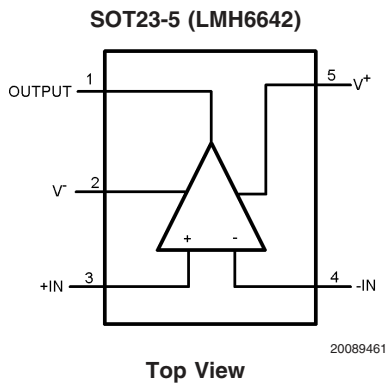

Typical Performance Characteristics

At $T_J = 25^\circ\text{C}$, $V^+ = +5$, $V^- = -5\text{V}$, $R_F = R_L = 2\text{k}\Omega$. Unless otherwise specified.

Closed Loop Frequency Response for Various Supplies

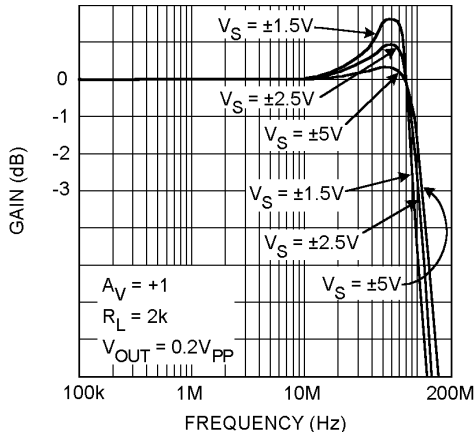

20089457

Closed Loop Gain vs. Frequency for Various Gain

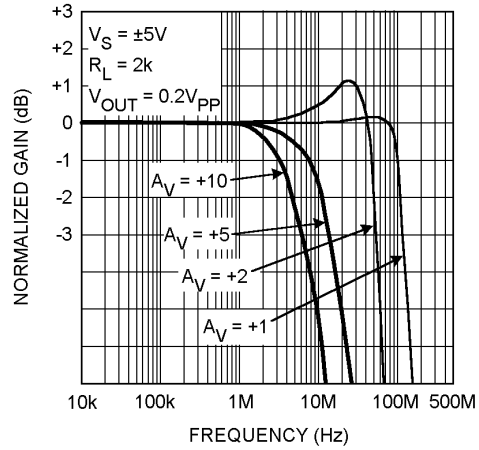

20089451

Closed Loop Gain vs. Frequency for Various Gain

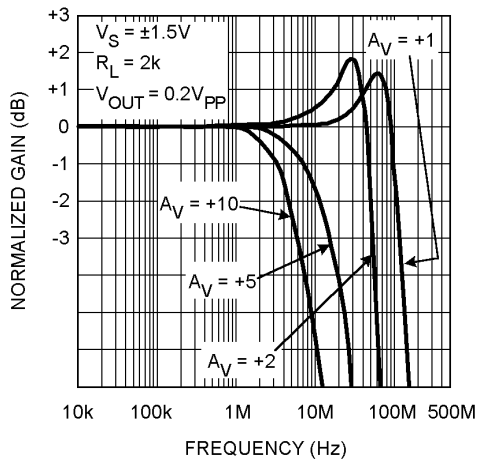

20089435

Closed Loop Frequency Response for Various Temperature

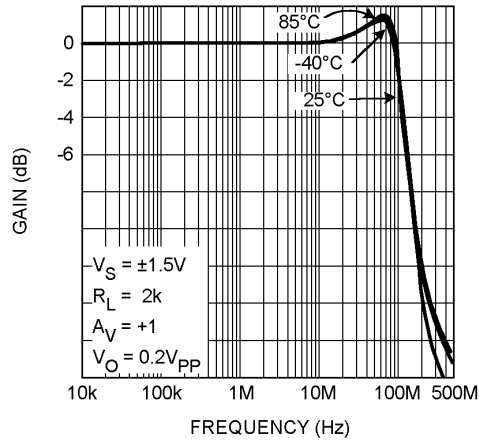

20089450

Closed Loop Gain vs. Frequency for Various Supplies

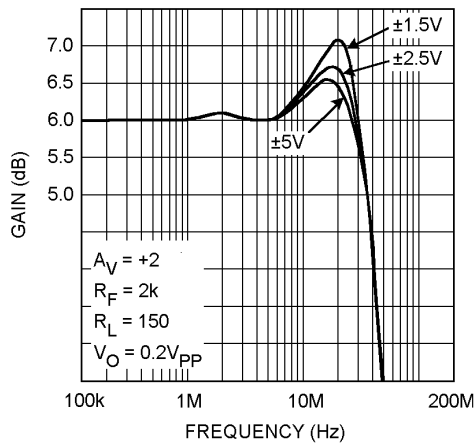

20089448

Closed Loop Frequency Response for Various Temperature

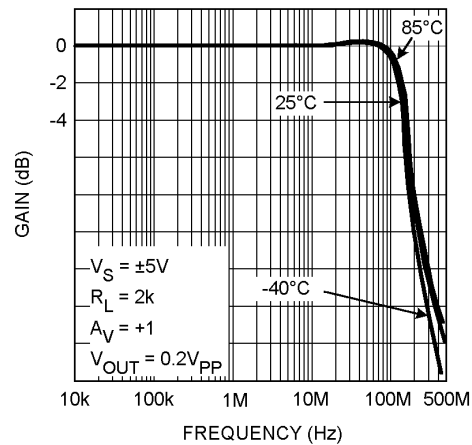

20089434

Typical Performance Characteristics At $T_J = 25^\circ\text{C}$, $V^+ = +5$, $V^- = -5$, $R_F = R_L = 2\text{k}\Omega$. Unless otherwise specified. (Continued)

Large Signal Frequency Response

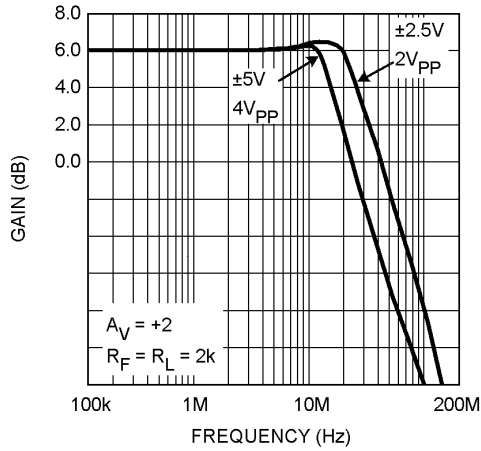

20089447

Closed Loop Small Signal Frequency Response for Various Supplies

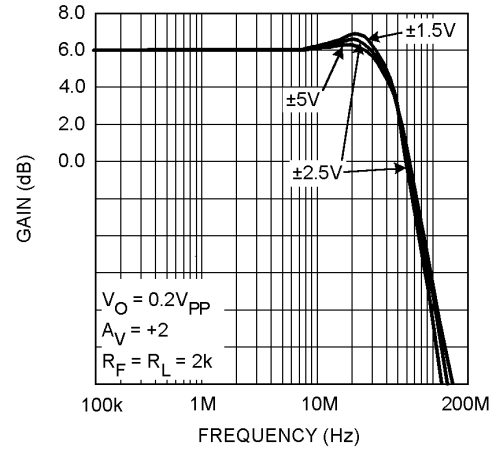

20089446

Closed Loop Frequency Response for Various Supplies

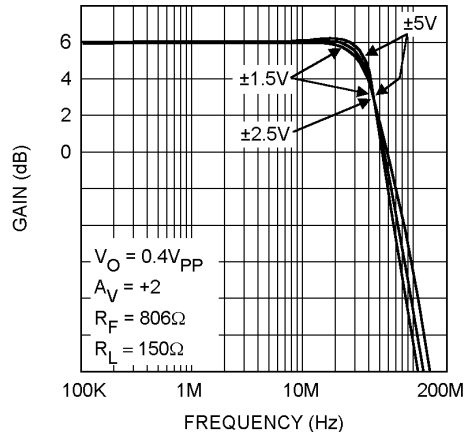

20089444

$\pm 0.1\text{dB}$ Gain Flatness for Various Supplies

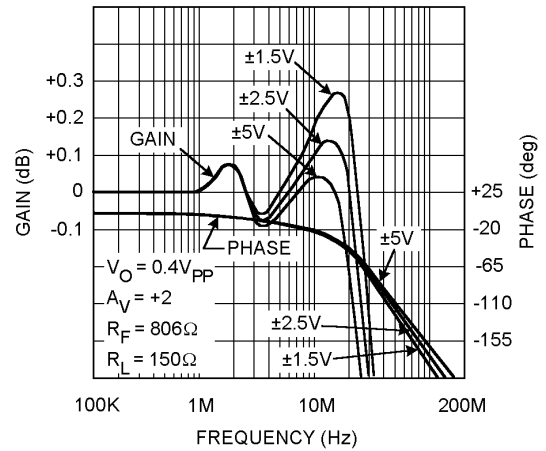

20089445

$V_{OUT} (V_{PP})$ for THD < 0.5%

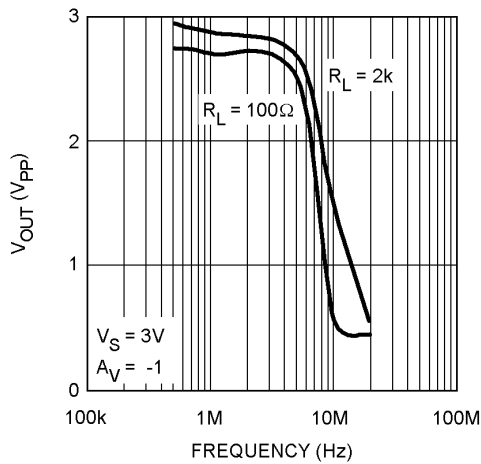

20089409

$V_{OUT} (V_{PP})$ for THD < 0.5%

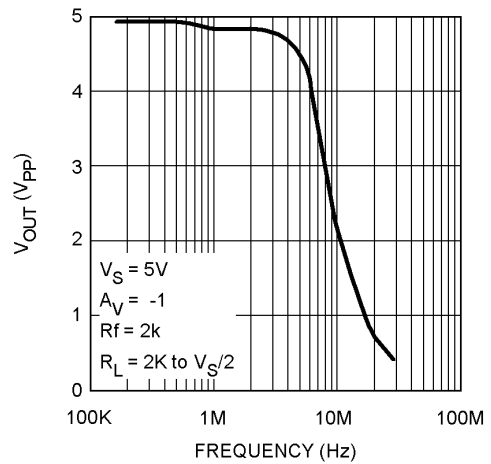

20089408

Typical Performance Characteristics At $T_J = 25^\circ\text{C}$, $V^+ = +5$, $V^- = -5$, $R_F = R_L = 2\text{k}\Omega$. Unless otherwise specified. (Continued)

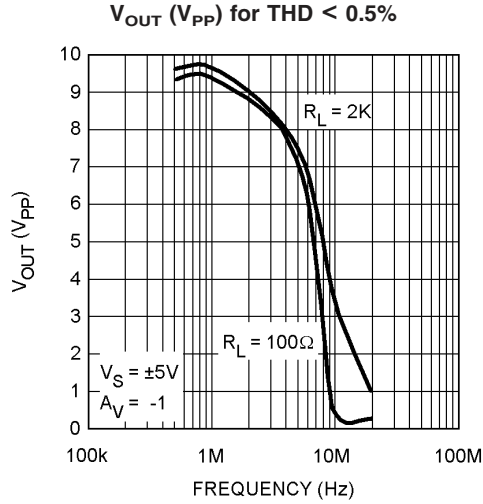

20089410

Open Loop Gain/Phase for Various Temperature

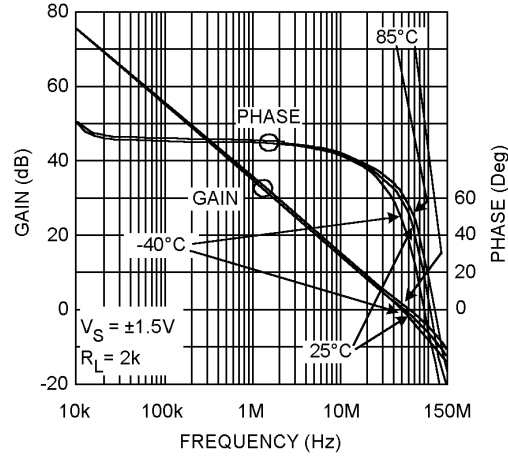

20089432

Open Loop Gain/Phase for Various Temperature

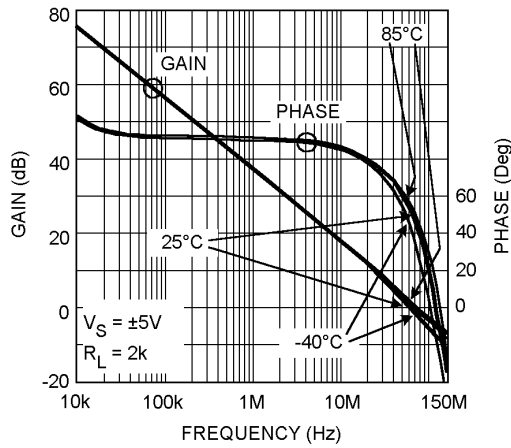

20089433

HD2 (dBc) vs. Output Swing

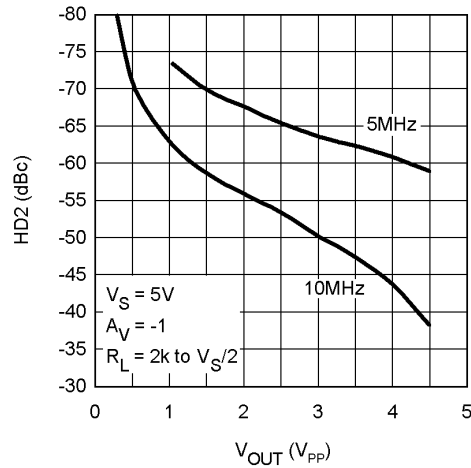

20089414

HD3 (dBc) vs. Output Swing

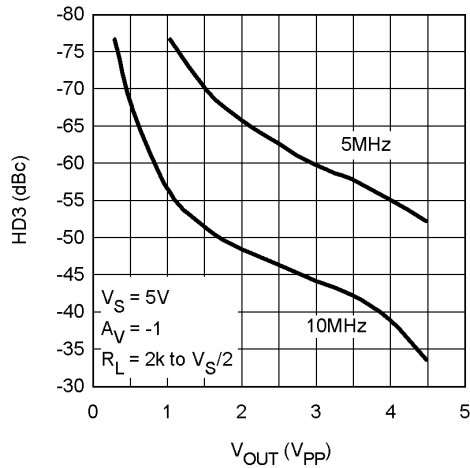

20089415

HD2 vs. Output Swing

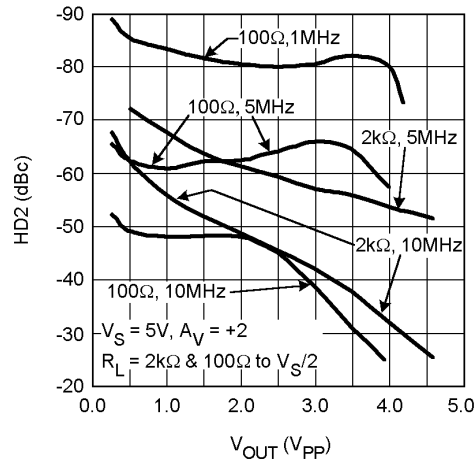

20089404

Typical Performance Characteristics At $T_J = 25^\circ\text{C}$, $V^+ = +5$, $V^- = -5$, $R_F = R_L = 2\text{k}\Omega$. Unless otherwise specified. (Continued)

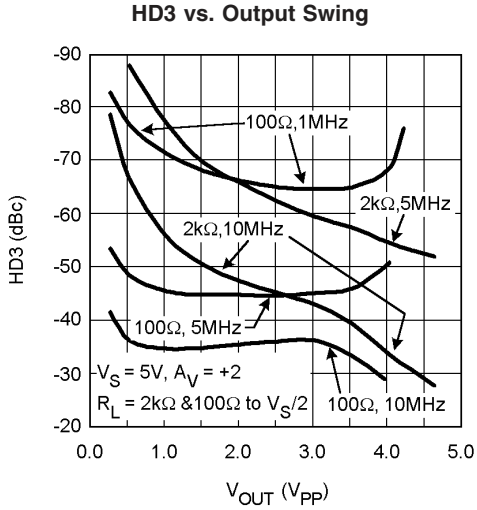

20089405

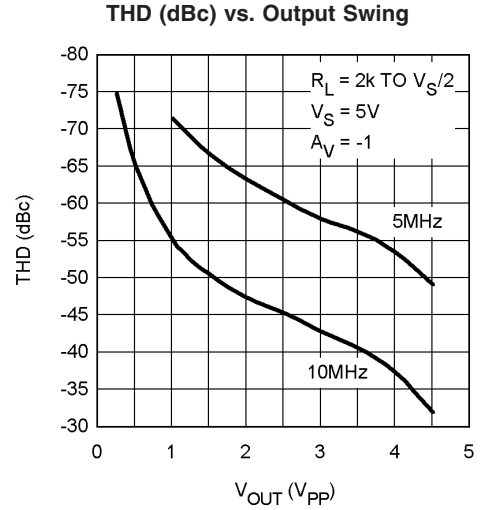

20089406

**Settling Time vs. Input Step Amplitude
(Output Slew and Settle Time)**

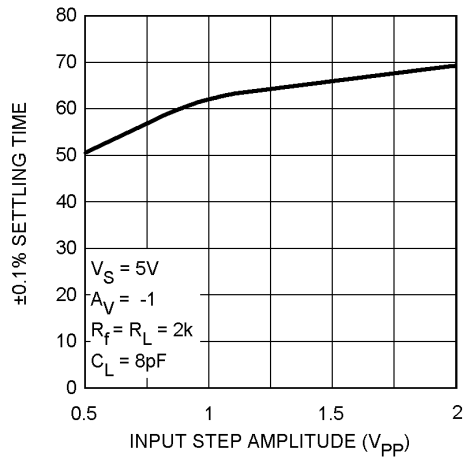

20089413

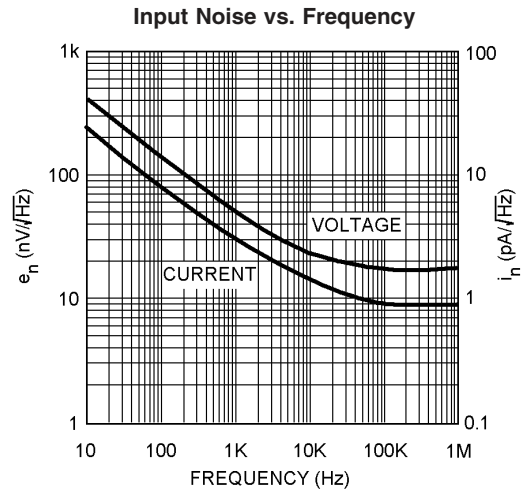

20089412

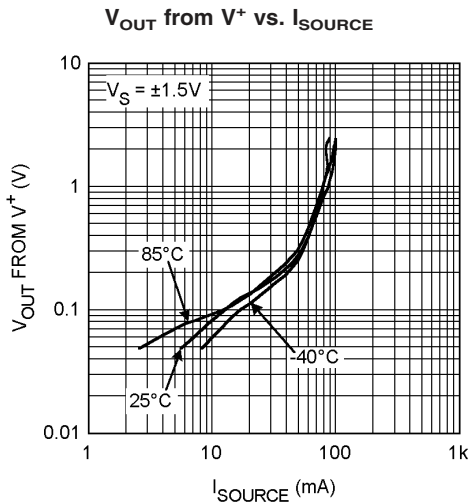

20089418

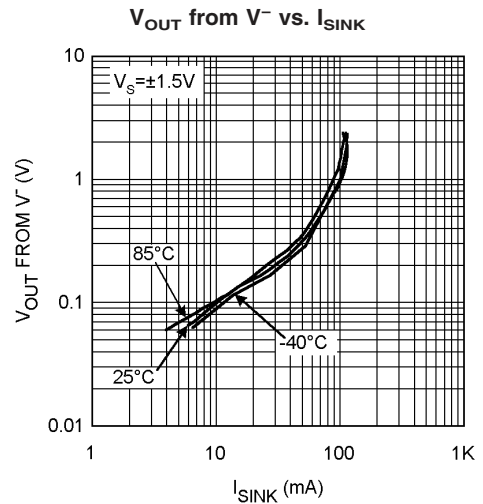

20089419

Typical Performance Characteristics At $T_J = 25^\circ\text{C}$, $V^+ = +5\text{V}$, $V^- = -5\text{V}$, $R_F = R_L = 2\text{k}\Omega$. Unless otherwise specified. (Continued)

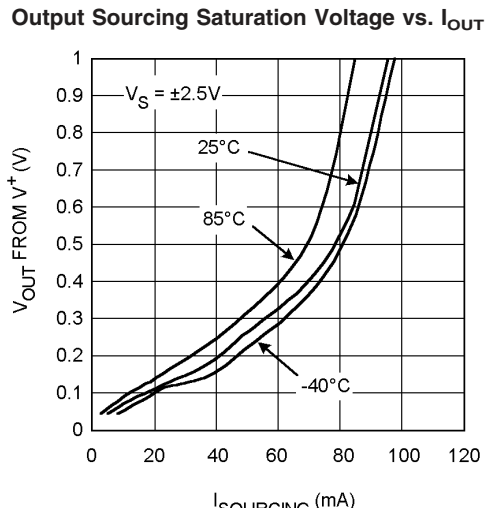
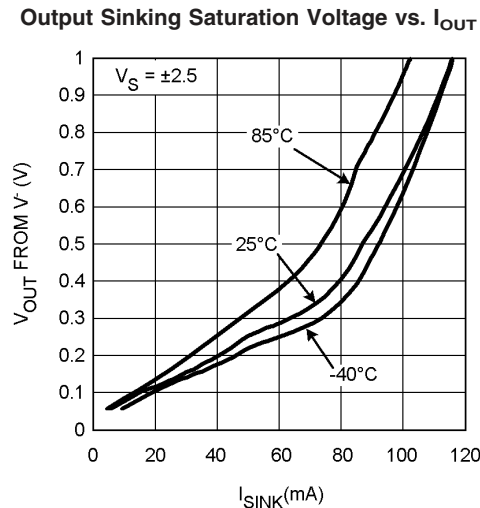
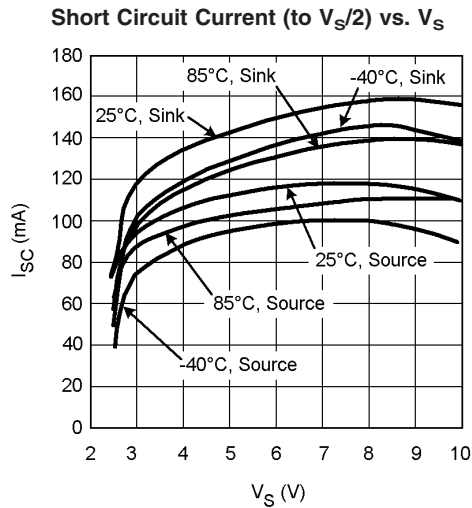
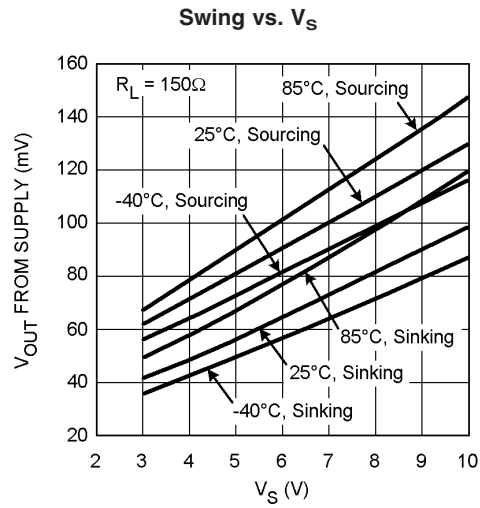
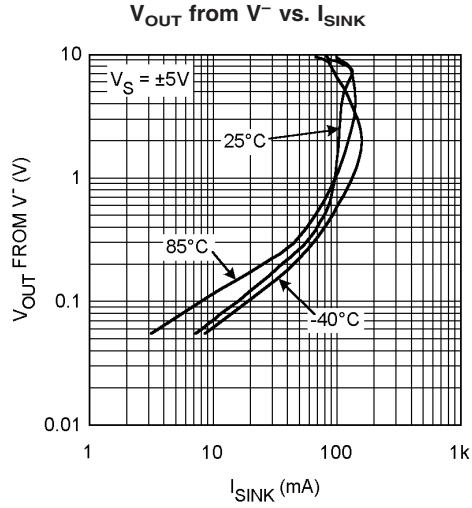
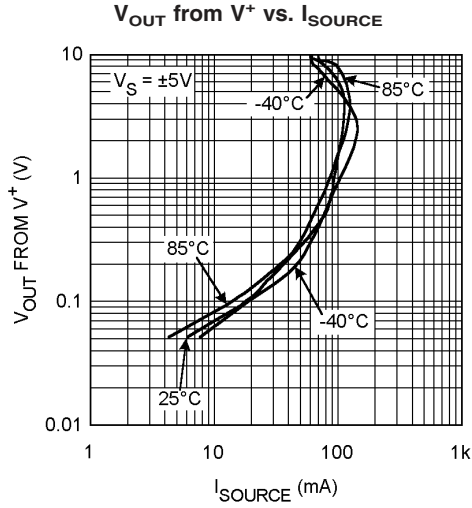

Typical Performance Characteristics

At $T_J = 25^\circ\text{C}$, $V^+ = +5$, $V^- = -5$, $R_F = R_L = 2\text{k}\Omega$. Unless otherwise specified. (Continued)

Closed Loop Output Impedance vs. Frequency $A_V = +1$

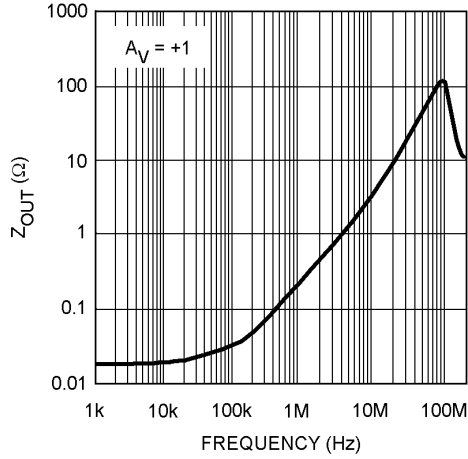

20089402

PSRR vs. Frequency

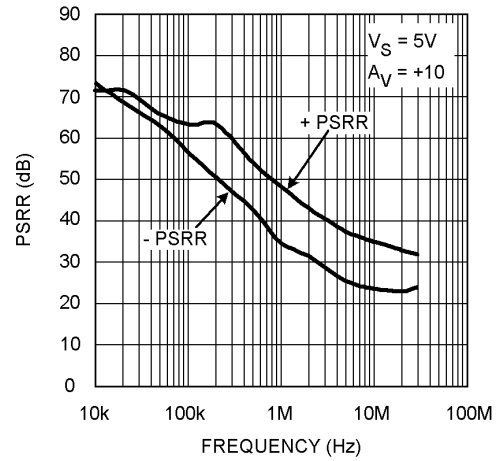

20089403

CMRR vs. Frequency

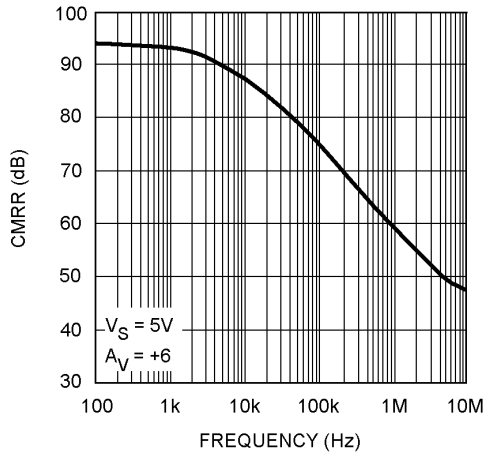

20089407

Crosstalk Rejection vs. Frequency (Output to Output)

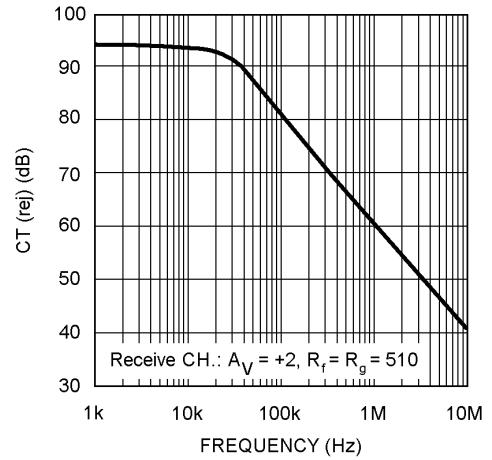

20089411

V_{OS} vs. V_{OUT} (Typical Unit)

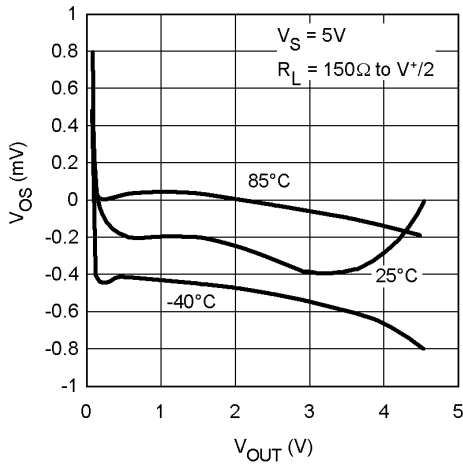

20089430

V_{OS} vs. V_{CM} (Typical Unit)

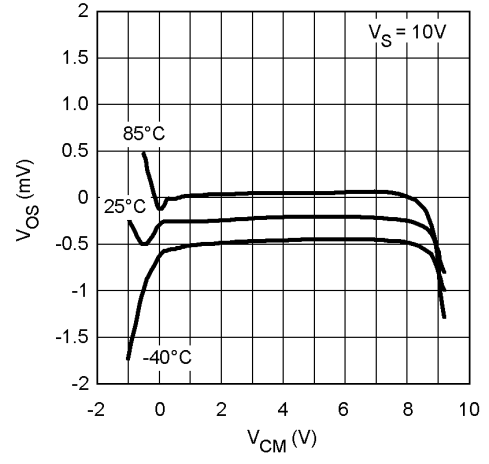

20089427

Typical Performance Characteristics At $T_J = 25^\circ\text{C}$, $V^+ = +5\text{V}$, $V^- = -5\text{V}$, $R_F = R_L = 2\text{k}\Omega$. Unless otherwise specified. (Continued)

V_{OS} vs. V_S (for 3 Representative Units)

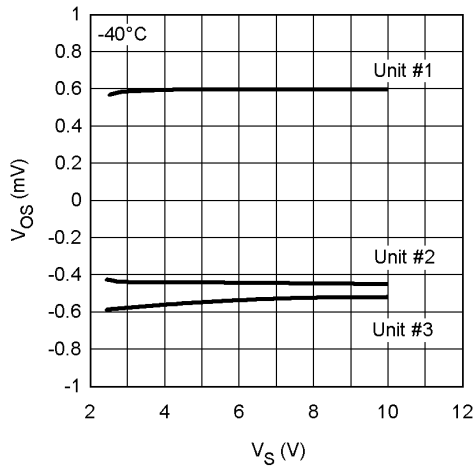

20089422

V_{OS} vs. V_S (for 3 Representative Units)

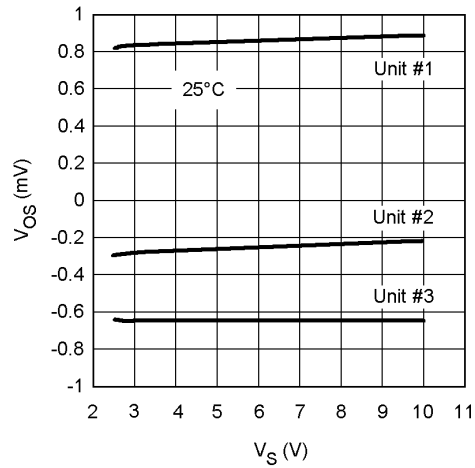

20089423

V_{OS} vs. V_S (for 3 Representative Units)

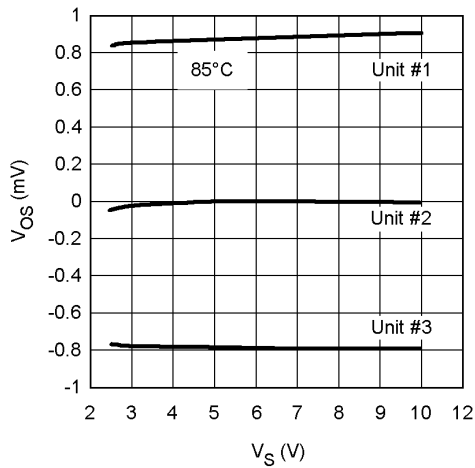

20089424

I_B vs. V_S

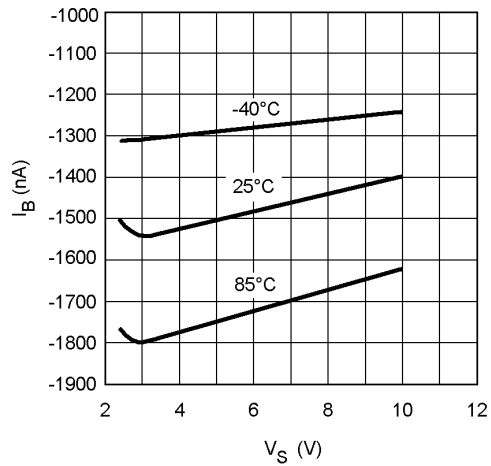

20089425

I_{OS} vs. V_S

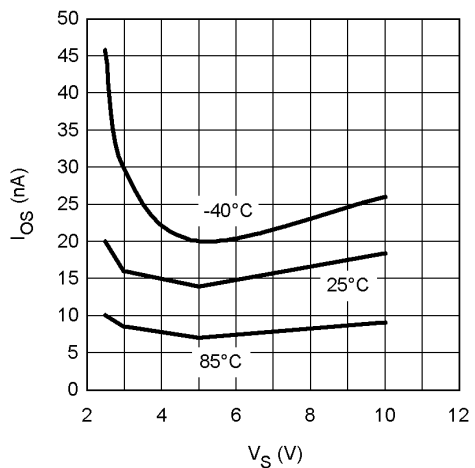

20089426

I_S vs. V_{CM}

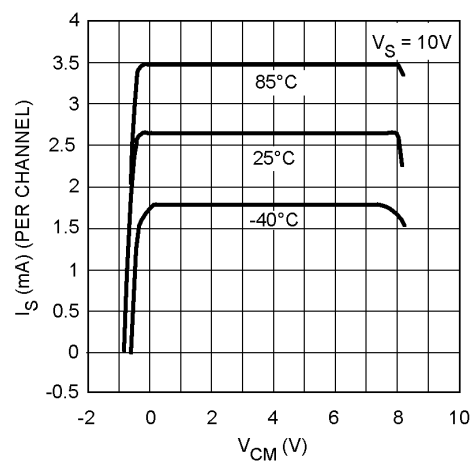

20089428

Typical Performance Characteristics At $T_J = 25^\circ\text{C}$, $V^+ = +5$, $V^- = -5$, $R_F = R_L = 2\text{k}\Omega$. Unless otherwise specified. (Continued)

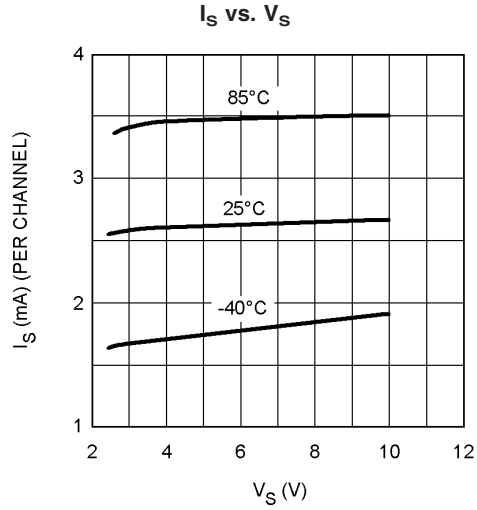

20089421

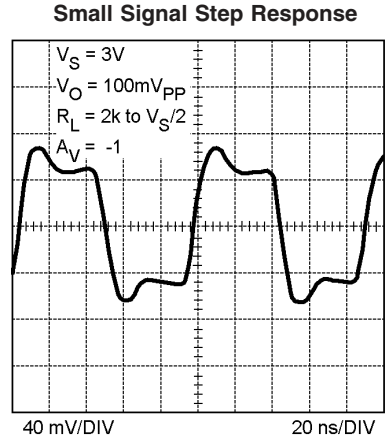

20089453

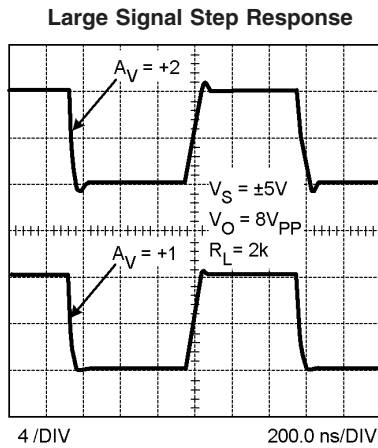

20089441

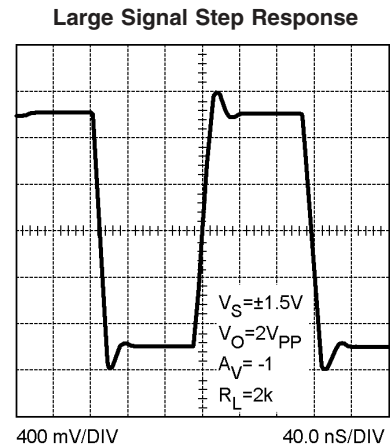

20089436

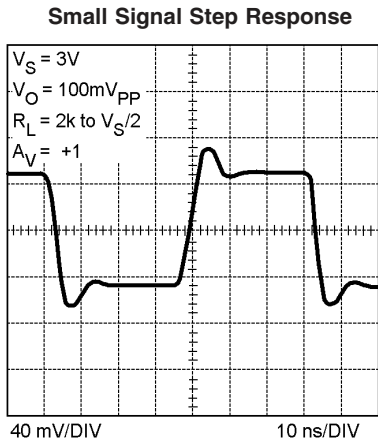

20089456

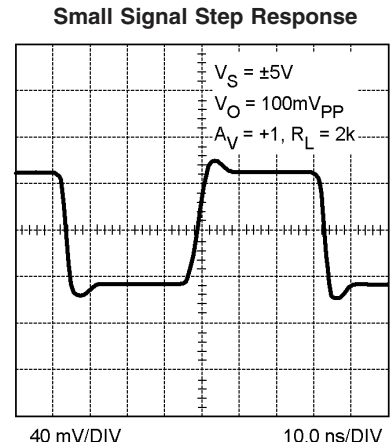

20089436

Typical Performance Characteristics At $T_J = 25^\circ\text{C}$, $V^+ = +5$, $V^- = -5$, $R_F = R_L = 2\text{k}\Omega$. Unless otherwise specified. (Continued)

Small Signal Step Response

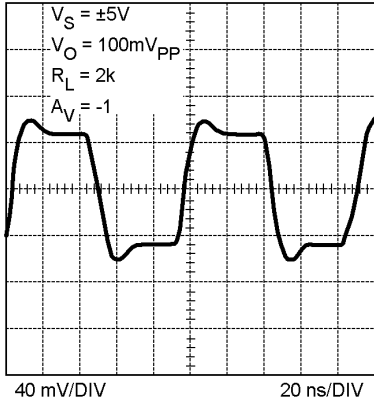

20089452

Small Signal Step Response

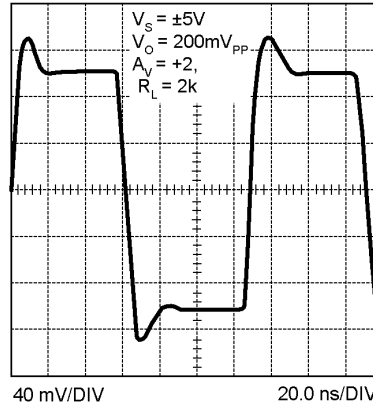

20089438

Large Signal Step Response

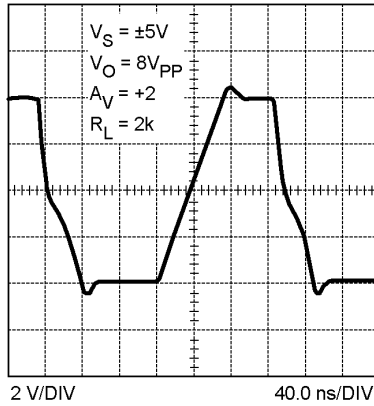

20089437

Large Signal Step Response

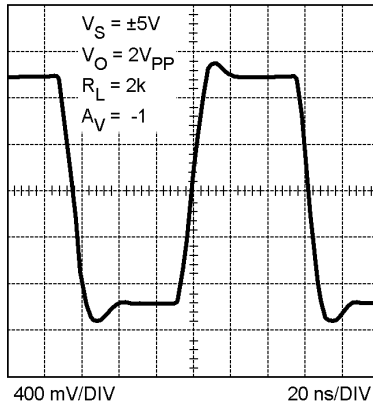

20089454

Large Signal Step Response

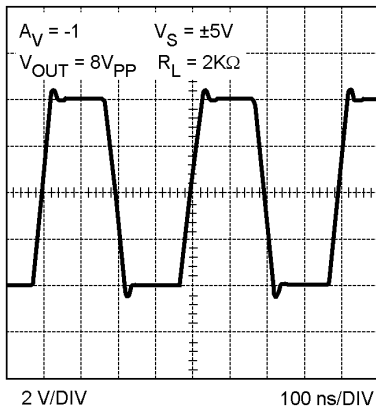

20089460

Application Notes

CIRCUIT DESCRIPTION

The LMH664XEP family is based on National Semiconductor's proprietary VIP10 dielectrically isolated bipolar process. This device family architecture features the following:

- Complimentary bipolar devices with exceptionally high f_t (~8GHz) even under low supply voltage (2.7V) and low bias current.
- A class A-B "turn-around" stage with improved noise, offset, and reduced power dissipation compared to similar speed devices (patent pending).
- Common Emitter push-push output stage capable of 75mA output current (at 0.5V from the supply rails) while consuming only 2.7mA of total supply current per channel. This architecture allows output to reach within millivolts of either supply rail.
- Consistent performance from any supply voltage (3V-10V) with little variation with supply voltage for the most important specifications (e.g. BW, SR, I_{OUT} , etc.)
- Significant power saving (~40%) compared to competitive devices on the market with similar performance.

Application Hints

This Op Amp family is a drop-in replacement for the AD805X family of high speed Op Amps in most applications. In addition, the LMH664XEP will typically save about 40% on power dissipation, due to lower supply current, when compared to competition. All AD805X family's guaranteed parameters are included in the list of LMH664XEP guaranteed specifications in order to ensure equal or better level of performance. However, as in most high performance parts, due to subtleties of applications, it is strongly recommended that the performance of the part to be evaluated is tested under actual operating conditions to ensure full compliance to all specifications.

With 3V supplies and a common mode input voltage range that extends 0.5V below V^- , the LMH664XEP find applications in low voltage/low power applications. Even with 3V supplies, the -3dB BW (@ $A_V = +1$) is typically 115MHz with a tested limit of 80MHz. Production testing guarantees that process variations will not compromise speed. High frequency response is exceptionally stable confining the typical -3dB BW over the industrial temperature range to $\pm 2.5\%$.

As can be seen from the typical performance plots, the LMH664XEP output current capability (~75mA) is enhanced compared to AD805X. This enhancement, increases the output load range, adding to the LMH664XEP's versatility.

Because of the LMH664XEP's high output current capability attention should be given to device junction temperature in order not to exceed the Absolute Maximum Rating.

This device family was designed to avoid output phase reversal. With input overdrive, the output is kept near supply rail (or as closed to it as mandated by the closed loop gain setting and the input voltage). See *Figure 1*:

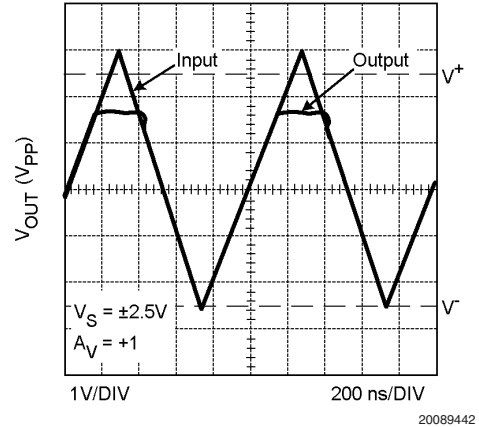

FIGURE 1. Input and Output Shown with CMVR Exceeded

However, if the input voltage range of $-0.5V$ to $1V$ from V^+ is exceeded by more than a diode drop, the internal ESD protection diodes will start to conduct. The current in the diodes should be kept at or below 10mA.

Output overdrive recovery time is less than 100ns as can be seen from *Figure 2* plot:

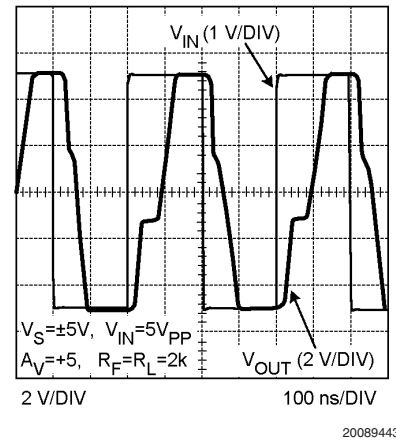

FIGURE 2. Overload Recovery Waveform

Application Notes (Continued)

SINGLE SUPPLY, LOW POWER PHOTODIODE AMPLIFIER

The circuit shown in *Figure 3* is used to amplify the current from a photo-diode into a voltage output. In this circuit, the emphasis is on achieving high bandwidth and the transimpedance gain setting is kept relatively low. Because of its high slew rate limit and high speed, the LMH664XEP family lends itself well to such an application.

This circuit achieves approximately 1V/mA of transimpedance gain and capable of handling up to 1mA_{pp} from the photodiode. Q1, in a common base configuration, isolates the high capacitance of the photodiode (C_d) from the Op Amp input in order to maximize speed. Input is AC coupled through C1 to ease biasing and allow single supply operation. With 5V single supply, the device input/output is shifted to near half supply using a voltage divider from V_{CC}. Note that Q1 collector does not have any voltage swing and the Miller effect is minimized. D1, tied to Q1 base, is for temperature compensation of Q1's bias point. Q1 collector current was set to be large enough to handle the peak-to-peak photodiode excitation and not too large to shift the U1 output too far from mid-supply.

No matter how low an R_f is selected, there is a need for C_f in order to stabilize the circuit. The reason for this is that the Op

Amp input capacitance and Q1 equivalent collector capacitance together (C_{IN}) will cause additional phase shift to the signal fed back to the inverting node. C_f will function as a zero in the feedback path counter-acting the effect of the C_{IN} and acting to stabilize the circuit. By proper selection of C_f such that the Op Amp open loop gain is equal to the inverse of the feedback factor at that frequency, the response is optimized with a theoretical 45° phase margin.

$$C_F = \sim \text{SQRT} \left[\frac{C_{IN}}{2\pi \cdot \text{GBWP} \cdot R_F} \right] \quad (1)$$

where GBWP is the Gain Bandwidth Product of the Op Amp. Optimized as such, the I-V converter will have a theoretical pole, f_p, at:

$$f_p = \text{SQRT} \left[\frac{\text{GBWP}}{2\pi R_F \cdot C_{IN}} \right] \quad (2)$$

With Op Amp input capacitance of 3pF and an estimate for Q1 output capacitance of about 3pF as well, C_{IN} = 6pF. From the typical performance plots, LMH6642EP/6643EP family GBWP is approximately 57MHz. Therefore, with R_f = 1k, from Equation 1 and 2 above.

C_f = ~4.1pF, and f_p = 39MHz

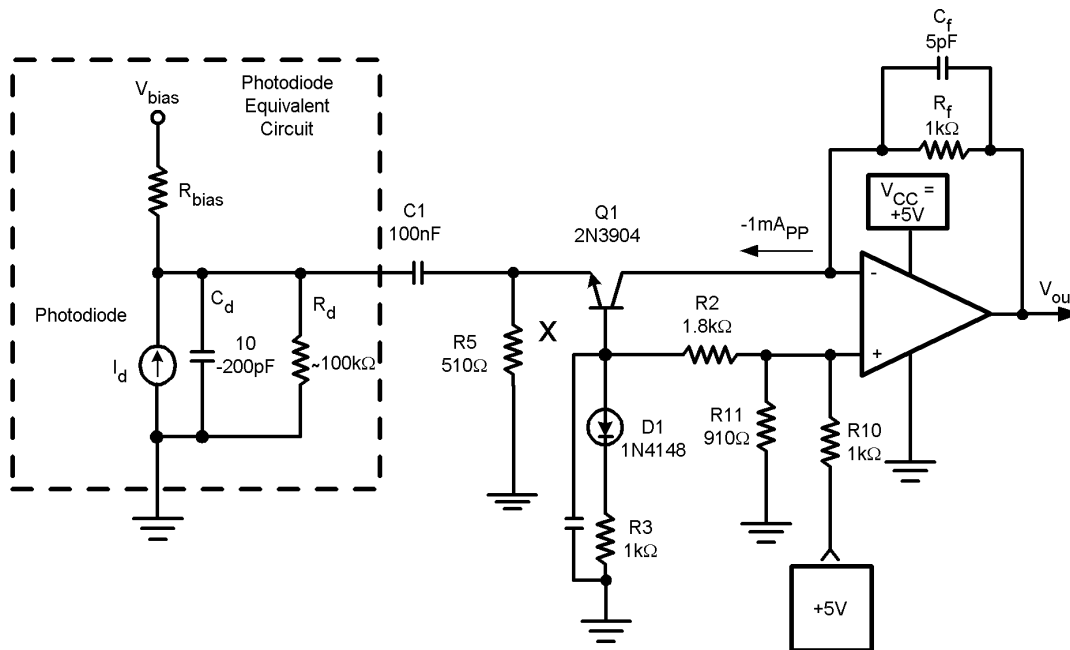

20089464

FIGURE 3. Single Supply Photodiode I-V Converter

Application Notes (Continued)

For this example, optimum C_f was empirically determined to be around 5pF. This time domain response is shown in *Figure 4* below showing about 9ns rise/fall times, corresponding to about 39MHz for f_p . The overall supply current from the +5V supply is around 5mA with no load.

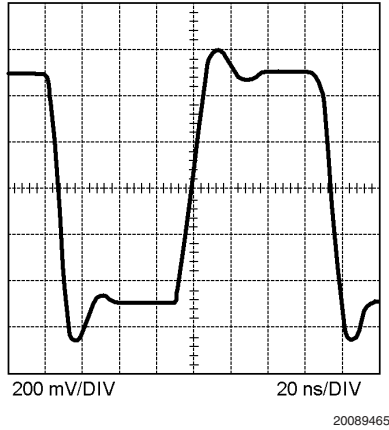

FIGURE 4. Converter Step Response ($1V_{PP}$, 20 ns/DIV)

PRINTED CIRCUIT BOARD LAYOUT AND COMPONENT VALUES SECTIONS

Generally, a good high frequency layout will keep power supply and ground traces away from the inverting input and

output pins. Parasitic capacitances on these nodes to ground will cause frequency response peaking and possible circuit oscillations (see Application Note OA-15 for more information). National Semiconductor suggests the following evaluation boards as a guide for high frequency layout and as an aid in device testing and characterization:

Device	Package	Evaluation Board PN
LMH6642MF	SOT23-5	CLC730068
LMH6642MF	8-Pin SOIC	CLC730027
LMH6643MA	8-Pin SOIC	CLC730036
LMH6643MA	8-Pin MSOP	CLC730123
LMH6644MA	14-Pin SOIC	CLC730031
LMH6644MA	14-Pin TSSOP	CLC730131

These free evaluation boards are shipped when a device sample request is placed with National Semiconductor.

Another important parameter in working with high speed/high performance amplifiers, is the component values selection. Choosing external resistors that are large in value will effect the closed loop behavior of the stage because of the interaction of these resistors with parasitic capacitances. These capacitors could be inherent to the device or a by-product of the board layout and component placement. Either way, keeping the resistor values lower, will diminish this interaction to a large extent. On the other hand, choosing very low value resistors could load down nodes and will contribute to higher overall power dissipation.

Physical Dimensions inches (millimeters) unless otherwise noted

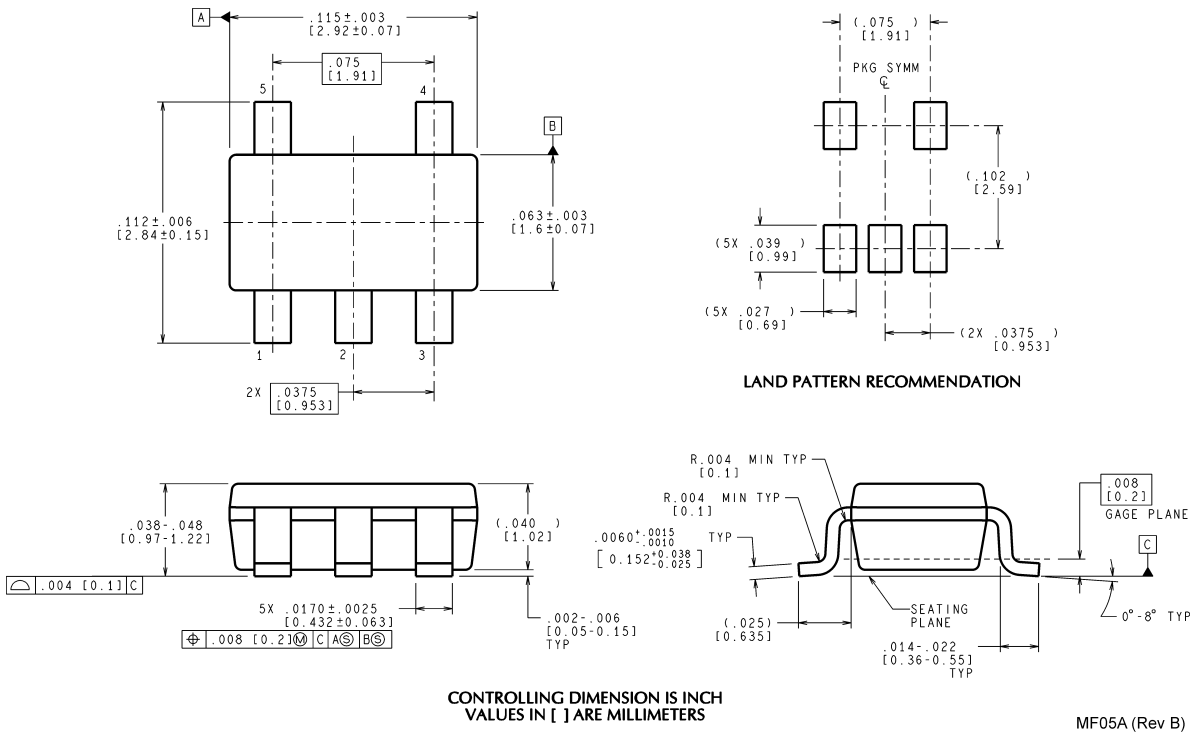

**5-Pin SOT23
NS Package Number MF05A**

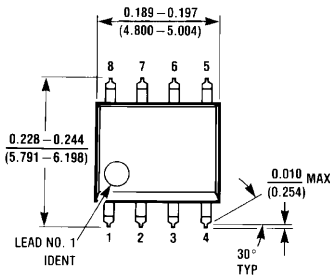

**8-Pin SOIC
NS Package Number M08A**

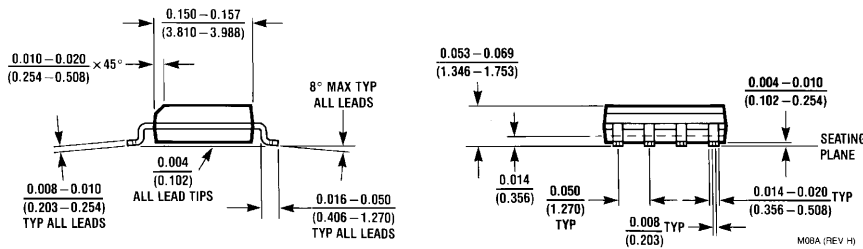

Physical Dimensions inches (millimeters) unless otherwise noted (Continued)

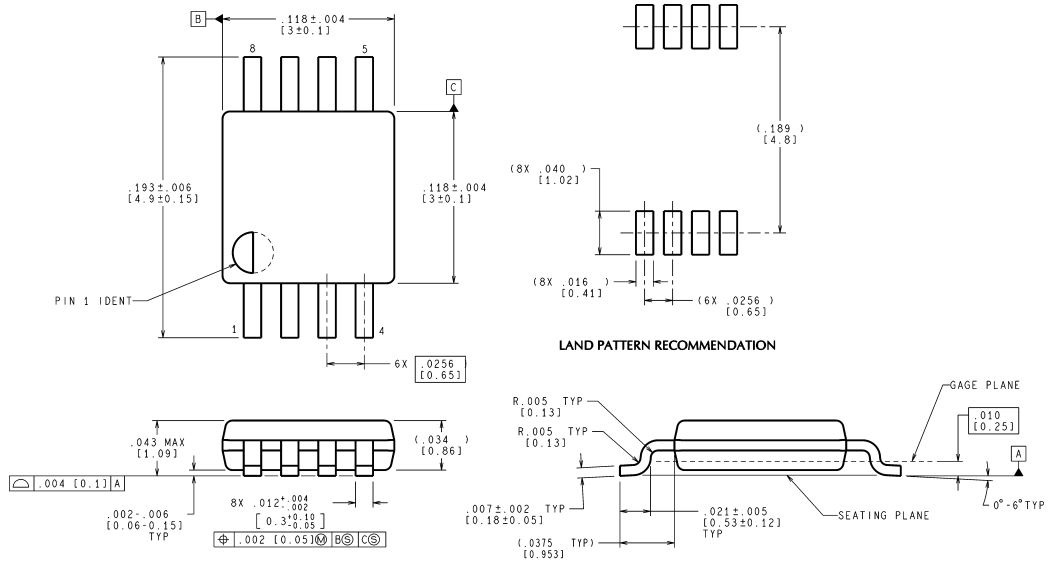

**8-Pin MSOP
NS Package Number MUA08A**

MUA08A (Rev E)

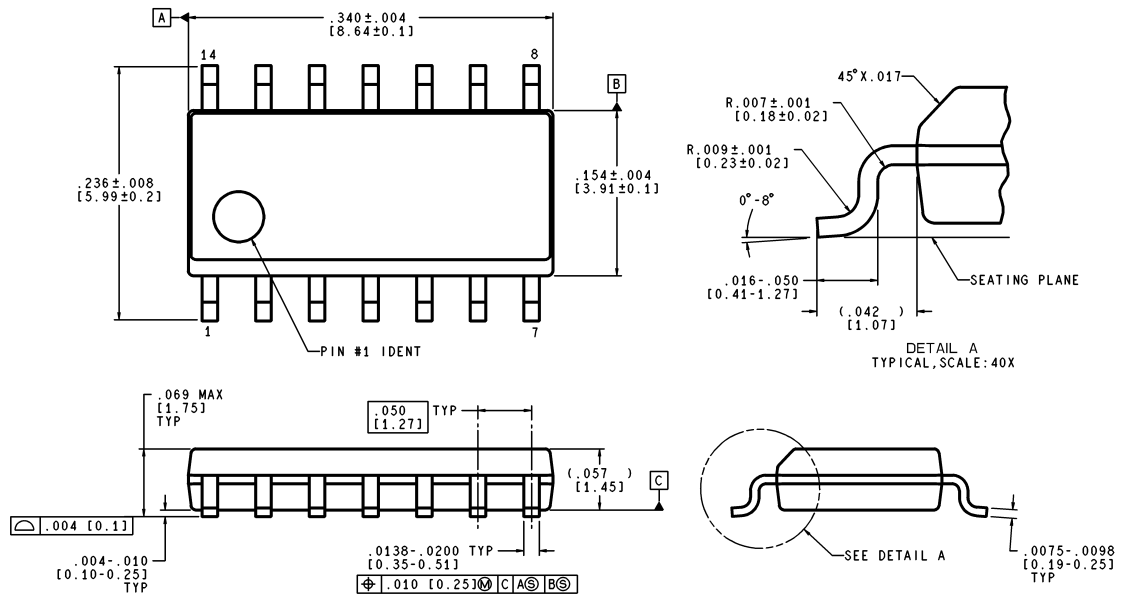

**14-Pin SOIC
NS Package Number M14A**

M14A (Rev J)

Physical Dimensions inches (millimeters) unless otherwise noted (Continued)

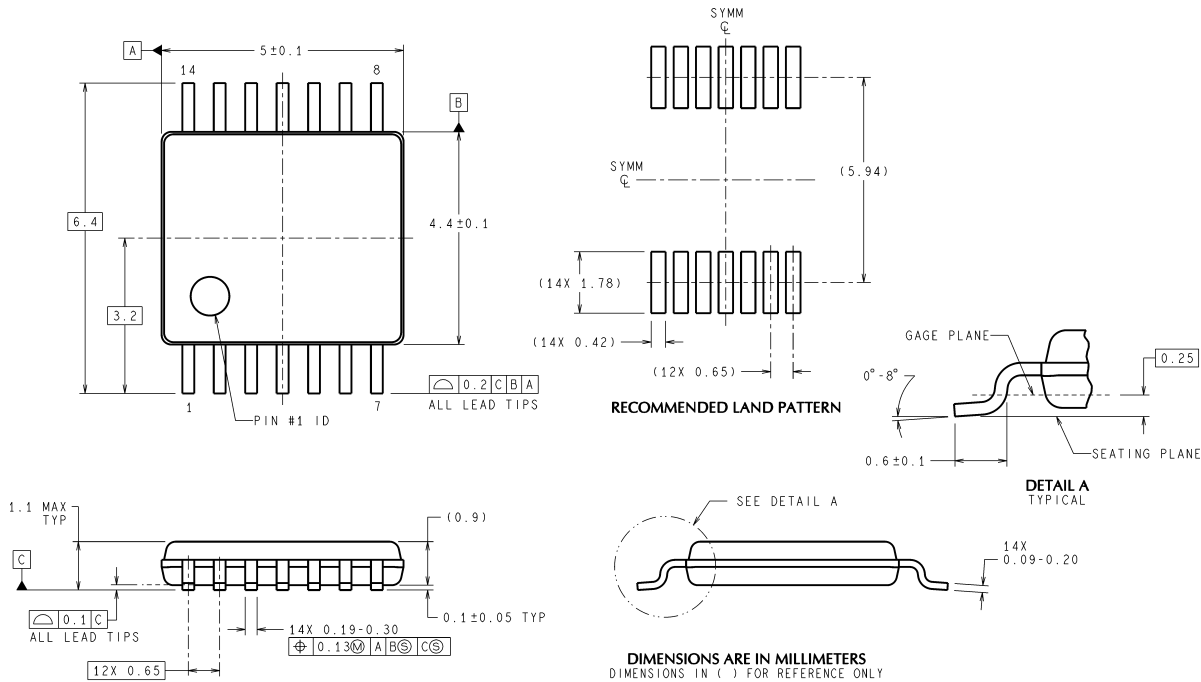

MTC14 (Rev D)

14-Pin TSSOP
NS Package Number MTC14

LIFE SUPPORT POLICY

NATIONAL'S PRODUCTS ARE NOT AUTHORIZED FOR USE AS CRITICAL COMPONENTS IN LIFE SUPPORT DEVICES OR SYSTEMS WITHOUT THE EXPRESS WRITTEN APPROVAL OF THE PRESIDENT AND GENERAL COUNSEL OF NATIONAL SEMICONDUCTOR CORPORATION. As used herein:

1. Life support devices or systems are devices or systems which, (a) are intended for surgical implant into the body, or (b) support or sustain life, and whose failure to perform when properly used in accordance with instructions for use provided in the labeling, can be reasonably expected to result in a significant injury to the user.
2. A critical component is any component of a life support device or system whose failure to perform can be reasonably expected to cause the failure of the life support device or system, or to affect its safety or effectiveness.

BANNED SUBSTANCE COMPLIANCE

National Semiconductor certifies that the products and packing materials meet the provisions of the Customer Products Stewardship Specification (CSP-9-111C2) and the Banned Substances and Materials of Interest Specification (CSP-9-111S2) and contain no "Banned Substances" as defined in CSP-9-111S2.



National Semiconductor
Americas Customer
Support Center
Email: new.feedback@nsc.com
Tel: 1-800-272-9959

National Semiconductor
Europe Customer Support Center
Fax: +49 (0) 180-530 85 86
Email: europe.support@nsc.com
Deutsch Tel: +49 (0) 69 9508 6208
English Tel: +44 (0) 870 24 0 2171
Français Tel: +33 (0) 1 41 91 8790

National Semiconductor
Asia Pacific Customer
Support Center
Email: ap.support@nsc.com

National Semiconductor
Japan Customer Support Center
Fax: 81-3-5639-7507
Email: jpn.feedback@nsc.com
Tel: 81-3-5639-7560

www.national.com