

# LMH6654/55

## Single/Dual Low Power, 250 MHz, Low Noise Amplifiers

### General Description

The LMH6654/55 single and dual high speed, voltage feedback amplifiers are designed to have unity-gain stable operation with a bandwidth of 250MHz. They operate from  $\pm 2.5V$  to  $\pm 6V$  and each channel consumes only 4.5mA. The amplifiers feature very low voltage noise and wide output swing to maximize signal-to-noise ratio.

The LMH6654/55 have a true single supply capability with input common mode voltage range extending 150 mV below negative rail and within 1.3V of the positive rail.

LMH6654/55 high speed and low power combination make these products an ideal choice for many portable, high speed application where power is at a premium.

The LMH6654 is packaged in SOT23-5 and SOIC-8. The LMH6655 is packaged in MSOP-8 and SOIC-8.

The LMH6654/55 are built on National's Advance VIP10™ (Vertically Integrated PNP) complementary bipolar process.

### Features

( $V_S = \pm 5V$ ,  $T_J = 25^\circ C$ , Typical values unless specified).

- Voltage feedback architecture
- Unity gain bandwidth 250MHz
- Supply voltage range  $\pm 2.5V$  to  $\pm 6V$
- Slew rate 200V/ $\mu$ sec
- Supply current 4.5mA/channel
- Input common mode voltage  $-5.15V$  to  $+3.7V$
- Output voltage swing ( $R_L = 100\Omega$ )  $-3.6V$  to  $3.4V$
- Input voltage noise  $4.5nV/\sqrt{Hz}$
- Input current noise  $1.7pA/\sqrt{Hz}$
- Settling Time to 0.01% 25ns

### Applications

- ADC drivers
- Consumer video
- Active filters
- Pulse delay circuits
- xDSL receiver
- Pre-amps

### Typical Performance Characteristics

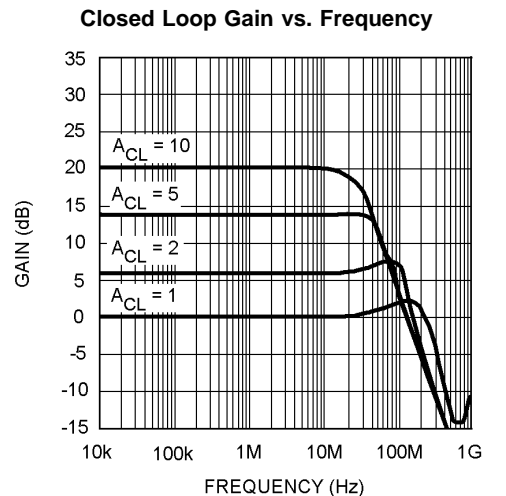
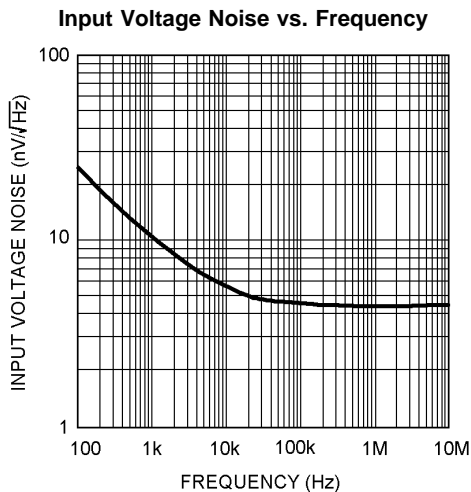

**Absolute Maximum Ratings** (Note 1)

If Military/Aerospace specified devices are required, please contact the National Semiconductor Sales Office/Distributors for availability and specifications.

ESD Tolerance (Note 2)	
Human Body Model	2kV
Machine Model	200V
$V_{IN}$ Differential	$\pm 1.2V$
Output Short Circuit Duration	(Note 3)
Supply Voltage ( $V^+ - V^-$ )	13.2V
Voltage at Input pins	$V^+ +0.5V, V^- -0.5V$
Storage Temperature Range	$-65^\circ C$ to $+150^\circ C$
Junction Temperature (Note 4)	$+150^\circ C$

## Soldering Information

Infrared or Convection (20 sec.)	$235^\circ C$
Wave Soldering (10 sec.)	$260^\circ C$

**Operating Ratings** (Note 1)

Supply Voltage ( $V^+ - V^-$ )	$\pm 2.5V$ to $\pm 6.0V$
Junction Temperature Range	$-40^\circ C$ to $+85^\circ C$
Thermal Resistance ( $\theta_{JA}$ )	
8-Pin SOIC	$172^\circ C/W$
8-Pin MSOP	$235^\circ C/W$
5-Pin SOT-23	$265^\circ C/W$

 **$\pm 5V$  Electrical Characteristics**

Unless otherwise specified, all limits guaranteed for  $T_J = 25^\circ C$ ,  $V^+ = +5V$ ,  $V^- = -5V$ ,  $V_{CM} = 0V$ ,  $A_V = +1$ ,  $R_F = 25\Omega$  for gain = +1,  $R_F = 402\Omega$  for gain =  $\geq +2$ , and  $R_L = 100\Omega$ . **Boldface** limits apply at the temperature extremes.

Symbol	Parameter	Conditions	Min (Note 6)	Typ (Note 5)	Max (Note 6)	Units
<b>Dynamic Performance</b>						
$f_{CL}$	Close Loop Bandwidth	$A_V = +1$		250		MHz
		$A_V = +2$		130		
		$A_V = +5$		52		
		$A_V = +10$		26		
GBWP	Gain Bandwidth Product	$A_V \geq +5$		260		MHz
	Bandwidth for 0.1dB Flatness	$A_V +1$		18		MHz
$\phi_m$	Phase Margin			50		deg
SR	Slew Rate (Note 8)	$A_V = +1, V_{IN} = 2V_{PP}$		200		V/ $\mu s$
$T_S$	Settling Time 0.01%	$A_V = +1, 2V$ Step		25		ns
				15		ns
$t_r$	Rise Time	$A_V = +1, 0.2V$ Step		1.4		ns
$t_f$	Fall Time	$A_V = +1, 0.2V$ Step		1.2		ns
<b>Distortion and Noise Response</b>						
$e_n$	Input Referred Voltage Noise	$f \geq 0.1$ MHz		4.5		nV/ $\sqrt{Hz}$
$i_n$	Input-Referred Current Noise	$f \geq 0.1$ MHz		1.7		pA/ $\sqrt{Hz}$
	Second Harmonic Distortion	$A_V = +1, f = 5MHz$		-80		dBc
	Third Harmonic Distortion	$V_O = 2V_{PP}, R_L = 100\Omega$		-85		
$X_t$	Crosstalk (for LMH6655 only)	Input Referred, 5MHz, Channel-to-Channel		-80		dB
DG	Differential Gain	$A_V = +2, NTSC, R_L = 150\Omega$		0.01		%
DP	Differential Phase	$A_V = +2, NTSC, R_L = 150\Omega$		0.025		deg
<b>Input Characteristics</b>						
$V_{OS}$	Input Offset Voltage	$V_{CM} = 0V$	-3 -4	$\pm 1$	3 4	mV
TC $V_{OS}$	Input Offset Average Drift	$V_{CM} = 0V$ (Note 7)		6		$\mu V/^\circ C$
$I_B$	Input Bias Current	$V_{CM} = 0V$		5	12 18	$\mu A$
$I_{OS}$	Input Offset Current	$V_{CM} = 0V$	-1 -2	0.3	1 2	$\mu A$
$R_{IN}$	Input Resistance	Common- Mode		4		M $\Omega$
		Differential Mode		20		k $\Omega$

## ±5V Electrical Characteristics (Continued)

Unless otherwise specified, all limits guaranteed for  $T_J = 25^\circ\text{C}$ ,  $V^+ = +5\text{V}$ ,  $V^- = -5\text{V}$ ,  $V_{\text{CM}} = 0\text{V}$ ,  $A_V = +1$ ,  $R_F = 25\Omega$  for gain = +1,  $R_F = 402\Omega$  for gain =  $\geq +2$ , and  $R_L = 100\Omega$ . **Boldface** limits apply at the temperature extremes.

Symbol	Parameter	Conditions	Min (Note 6)	Typ (Note 5)	Max (Note 6)	Units
$C_{\text{IN}}$	Input Capacitance	Common- Mode		1.8		pF
		Differential Mode		1		
CMRR	Common Mode Rejection Ratio	Input Referred, $V_{\text{CM}} = 0\text{V to } -5\text{V}$	70 <b>68</b>	90		dB
CMVR	Input Common- Mode Voltage Range	CMRR $\geq 50\text{dB}$		-5.15	-5.0	V
				3.5	3.7	
<b>Transfer Characteristics</b>						
$A_{\text{VOL}}$	Large Signal Voltage Gain	$V_O = 4V_{\text{PP}}$ , $R_L = 100\Omega$	60 <b>58</b>	67		dB
<b>Output Characteristics</b>						
$V_O$	Output Swing High	No Load	3.4 <b>3.2</b>	3.6		V
	Output Swing Low	No Load		-3.9	-3.7 <b>-3.5</b>	
	Output Swing High	$R_L = 100\Omega$	3.2 <b>3.0</b>	3.4		
	Output Swing Low	$R_L = 100\Omega$		-3.6	-3.4 <b>-3.2</b>	
$I_{\text{SC}}$	Short Circuit Current (Note 3)	Sourcing, $V_O = 0\text{V}$ $\Delta V_{\text{IN}} = 200\text{mV}$	145 <b>130</b>	280		mA
		Sinking, $V_O = 0\text{V}$ $\Delta V_{\text{IN}} = 200\text{mV}$	100 <b>80</b>	185		
$I_{\text{OUT}}$	Output Current	Sourcing, $V_O = +3\text{V}$		80		mA
		Sinking, $V_O = -3\text{V}$		120		
$R_O$	Output Resistance	$A_V = +1$ , $f < 100\text{kHz}$		0.08		$\Omega$
<b>Power Supply</b>						
PSRR	Power Supply Rejection Ratio	Input Referred , $V_S = \pm 5\text{V to } \pm 6\text{V}$	60	76		dB
$I_S$	Supply Current (per channel)			4.5	6 <b>7</b>	mA

## 5V Electrical Characteristics

Unless otherwise specified, all limits guaranteed for  $T_J = 25^\circ\text{C}$ ,  $V^+ = +5\text{V}$ ,  $V^- = -0\text{V}$ ,  $V_{\text{CM}} = 2.5\text{V}$ ,  $A_V = +1$ ,  $R_F = 25\Omega$  for gain = +1,  $R_F = 402\Omega$  for gain =  $\geq +2$ , and  $R_L = 100\Omega$  to  $V^+/2$ . **Boldface** limits apply at the temperature extremes.

Symbol	Parameter	Conditions	Min (Note 6)	Typ (Note 5)	Max (Note 6)	Units
<b>Dynamic Performance</b>						
$f_{\text{CL}}$	Close Loop Bandwidth	$A_V = +1$		230		MHz
		$A_V = +2$		120		
		$A_V = +5$		50		
		$A_V = +10$		25		
GBWP	Gain Bandwidth Product	$A_V \geq +5$		250		MHz
	Bandwidth for 0.1dB Flatness	$A_V = +1$		17		MHz
$\phi_m$	Phase Margin			48		deg
SR	Slew Rate (Note 8)	$A_V = +1$ , $V_{\text{IN}} = 2V_{\text{PP}}$		190		V/ $\mu\text{s}$
$T_S$	Settling Time	$A_V = +1$ , 2V Step		30		ns
			0.01%		20	
	0.1%					ns

## 5V Electrical Characteristics (Continued)

Unless otherwise specified, all limits guaranteed for  $T_J = 25^\circ\text{C}$ ,  $V^+ = +5\text{V}$ ,  $V^- = -0\text{V}$ ,  $V_{\text{CM}} = 2.5\text{V}$ ,  $A_V = +1$ ,  $R_F = 25\Omega$  for gain = +1,  $R_F = 402\Omega$  for gain =  $\geq +2$ , and  $R_L = 100\Omega$  to  $V^+/2$ . **Boldface** limits apply at the temperature extremes.

Symbol	Parameter	Conditions	Min (Note 6)	Typ (Note 5)	Max (Note 6)	Units
$t_r$	Rise Time	$A_V = +1$ , 0.2V Step		1.5		ns
$t_f$	Fall Time	$A_V = +1$ , 0.2V Step		1.35		ns
<b>Distortion and Noise Response</b>						
$e_n$	Input Referred Voltage Noise	$f \geq 0.1\text{MHz}$		4.5		$\text{nV}/\sqrt{\text{Hz}}$
$i_n$	Input Referred Current Noise	$f \geq 0.1\text{ MHz}$		1.7		$\text{pA}/\sqrt{\text{Hz}}$
	Second Harmonic Distortion	$A_V = +1$ , $f = 5\text{MHz}$		-65		dBc
	Third Harmonic Distortion	$V_O = 2V_{\text{PP}}$ , $R_L = 100\Omega$		-70		
$X_t$	Crosstalk (for LMH6655 only)	Input Referred, 5MHz		-78		dB
<b>Input Characteristics</b>						
$V_{\text{OS}}$	Input Offset Voltage	$V_{\text{CM}} = 2.5\text{V}$	-5 <b>-6.5</b>	$\pm 2$	5 <b>6.5</b>	mV
TC $V_{\text{OS}}$	Input Offset Average Drift	$V_{\text{CM}} = 2.5\text{V}$ (Note 7)		<b>6</b>		$\mu\text{V}/^\circ\text{C}$
$I_B$	Input Bias Current	$V_{\text{CM}} = 2.5\text{V}$		6	12 <b>18</b>	$\mu\text{A}$
$I_{\text{OS}}$	Input Offset Current	$V_{\text{CM}} = 2.5\text{V}$	-2 <b>-3</b>	0.5	2 <b>3</b>	$\mu\text{A}$
$R_{\text{IN}}$	Input Resistance	Common- Mode		4		M $\Omega$
		Differential Mode		20		k $\Omega$
$C_{\text{IN}}$	Input Capacitance	Common- Mode		1.8		pF
		Differential Mode		1		
CMRR	Common Mode Rejection Ratio	Input Referred, $V_{\text{CM}} = 0\text{V}$ to $-2.5\text{V}$	70 <b>68</b>	90		dB
CMVR	Input Common Mode Voltage Range	CMRR $\geq 50\text{dB}$		-0.15	0	V
				3.5	3.7	
<b>Transfer Characteristics</b>						
$A_{\text{VOL}}$	Large Signal Voltage Gain	$V_O = 1.6V_{\text{PP}}$ , $R_L = 100\Omega$	58 <b>55</b>	64		dB
<b>Output Characteristics</b>						
$V_O$	Output Swing High	No Load	3.6 <b>3.4</b>	3.75		V
	Output Swing Low	No Load		0.9	1.1 <b>1.3</b>	
	Output Swing High	$R_L = 100\Omega$	3.5 <b>3.35</b>	3.70		
	Output Swing Low	$R_L = 100\Omega$		1	1.3 <b>1.45</b>	
$I_{\text{SC}}$	Short Circuit Current (Note 3)	Sourcing, $V_O = 2.5\text{V}$ $\Delta V_{\text{IN}} = 200\text{mV}$	90 <b>80</b>	170		mA
		Sinking, $V_O = 2.5\text{V}$ $\Delta V_{\text{IN}} = 200\text{mV}$	70 <b>60</b>	140		
$I_{\text{OUT}}$	Output Current	Sourcing, $V_O = +3.5\text{V}$		30		mA
		Sinking, $V_O = 1.5\text{V}$		60		
$R_O$	Output Resistance	$A_V = +1$ , $f < 100\text{kHz}$		.08		$\Omega$
<b>Power Supply</b>						
PSRR	Power Supply Rejection Ratio	Input Referred, $V_S = \pm 2.5\text{V}$ to $\pm 3\text{V}$	60	75		dB
$I_S$	Supply Current (per channel)			4.5	6 <b>7</b>	mA

## 5V Electrical Characteristics (Continued)

**Note 1:** Absolute Maximum Ratings indicate limits beyond which damage to the device may occur. Operating Ratings indicate conditions for which the device is intended to be functional, but specific performance is not guaranteed. For guaranteed specifications and the test conditions, see the Electrical Characteristics Table.

**Note 2:** Human body model, 1.5kΩ in series with 100pF. Machine model: 0Ω in series with 100pF.

**Note 3:** Continuous short circuit operation at elevated ambient temperature can result in exceeding the maximum allowed junction temperature at 150°C.

**Note 4:** The maximum power dissipation is a function of  $T_{J(MAX)}$ ,  $\theta_{JA}$  and  $T_A$ . The maximum allowable power dissipation at any ambient temperature is  $P_D = (T_{J(MAX)} - T_A)/\theta_{JA}$ . All numbers apply for packages soldered directly onto a PC board.

**Note 5:** Typical Values represent the most likely parametric norm.

**Note 6:** All limits are guaranteed by testing or statistical analysis.

**Note 7:** Offset voltage average drift is determined by dividing the change in  $V_{OS}$  at temperature extremes into the total temperature change.

**Note 8:** Slew rate is the slower of the rising and falling slew rates. Slew rate is rate of change from 10% to 90% of output voltage step.

**Typical Performance Characteristics**  $T_J = 25^\circ\text{C}$ ,  $V^+ = \pm 5\text{V}$ ,  $V^- = -5$ ,  $R_F = 25\Omega$  for gain = +1,  $R_F = 402\Omega$  and for gain  $\geq +2$ , and  $R_L = 100\Omega$ , unless otherwise specified.

**Closed Loop Bandwidth (G = +1)**

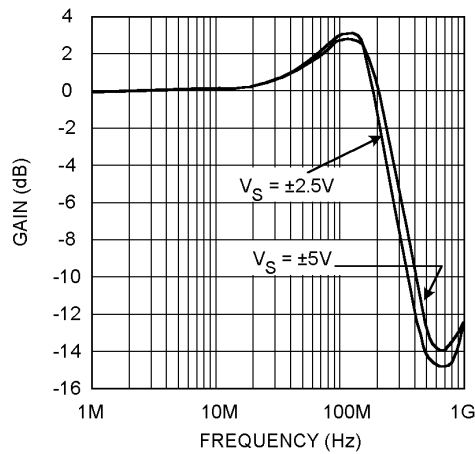

20016509

**Closed Loop Bandwidth (G = +2)**

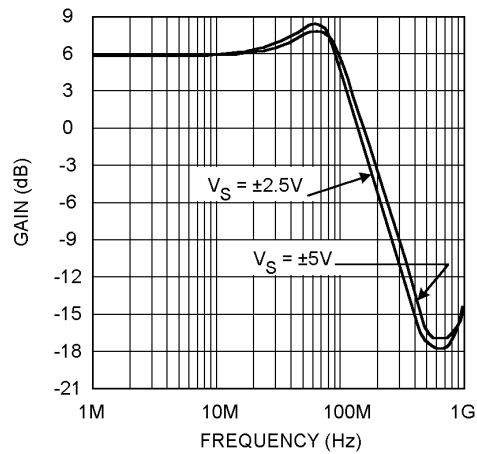

20016510

**Closed Loop Bandwidth (G = +5)**

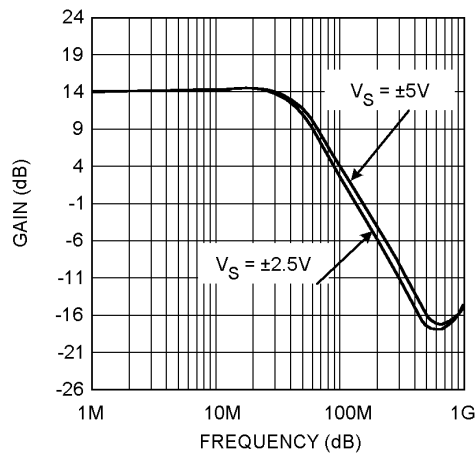

20016511

**Closed Loop Bandwidth (G = +10)**

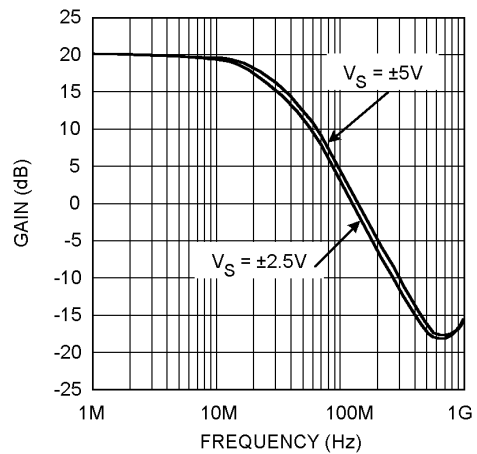

20016512

**Typical Performance Characteristics**  $T_J = 25^\circ\text{C}$ ,  $V^+ = \pm 5\text{V}$ ,  $V^- = -5$ ,  $R_F = 25\Omega$  for gain = +1,  $R_F = 402\Omega$  and for gain  $\geq +2$ , and  $R_L = 100\Omega$ , unless otherwise specified. (Continued)

**Supply Current per Channel vs. Supply Voltage**

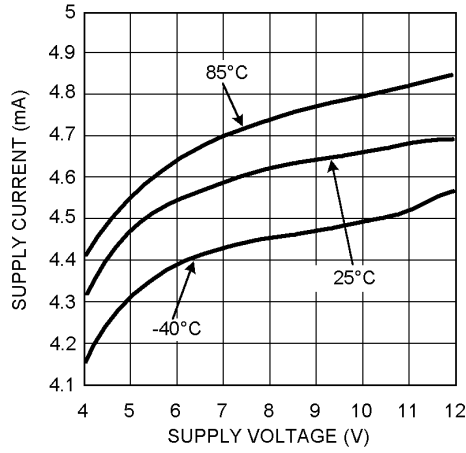

20016535

**Supply Current per Channel vs. Temperature**

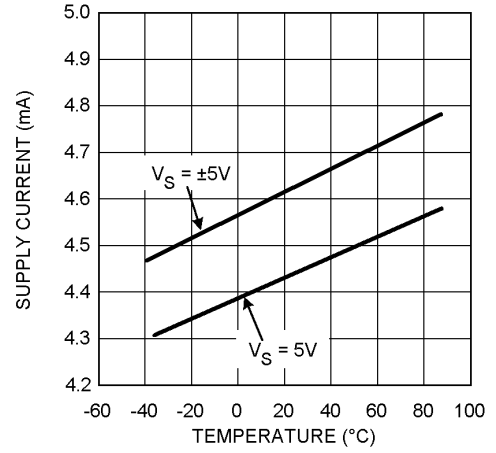

20016548

**Offset Voltage vs. Supply Voltage ( $V_{CM} = 0\text{V}$ )**

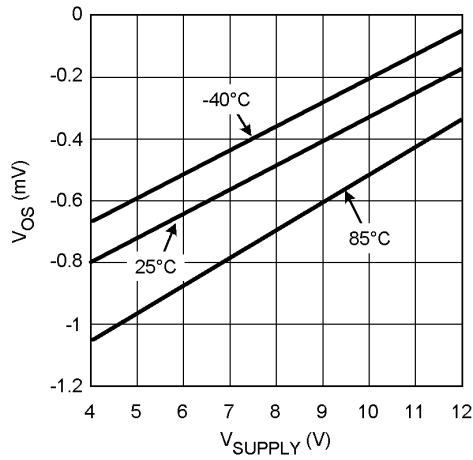

20016549

**Offset Voltage vs. Common Mode**

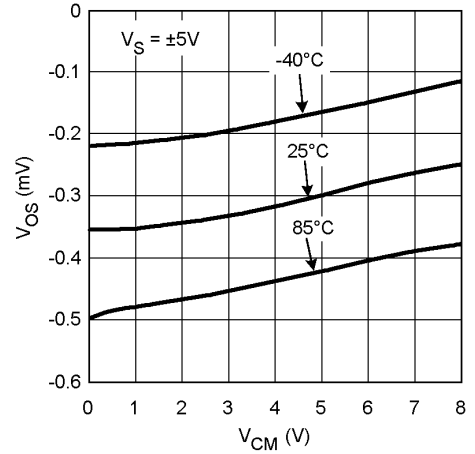

20016532

**Offset Voltage vs. Common Mode**

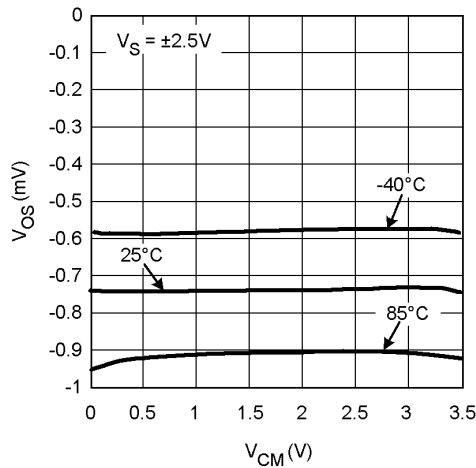

20016539

**Bias Current and Offset Voltage vs. Temperature**

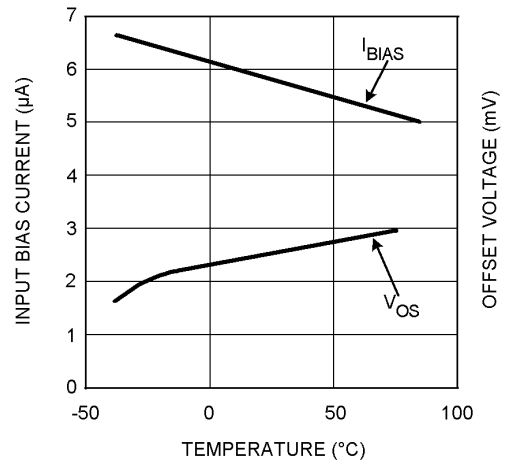

20016551

**Typical Performance Characteristics**  $T_J = 25^\circ\text{C}$ ,  $V^+ = \pm 5\text{V}$ ,  $V^- = -5$ ,  $R_F = 25\Omega$  for gain = +1,  $R_F = 402\Omega$  and for gain  $\geq +2$ , and  $R_L = 100\Omega$ , unless otherwise specified. (Continued)

**Bias Current vs. Common Mode Voltage**

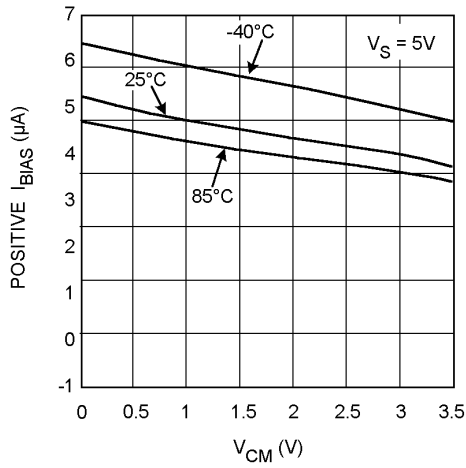

20016537

**A<sub>OL</sub>, PSRR and CMRR vs. Temperature**

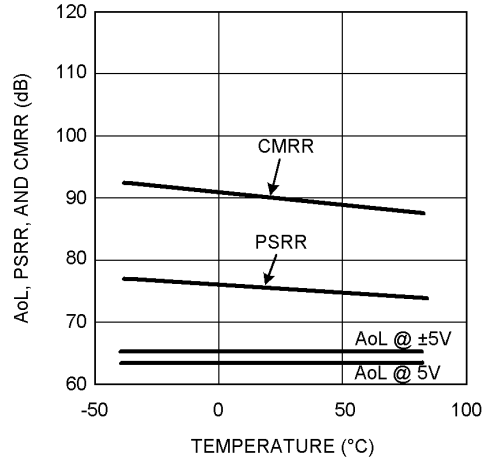

20016550

**Inverting Large Signal Pulse Response ( $V_S = 5\text{V}$ )**

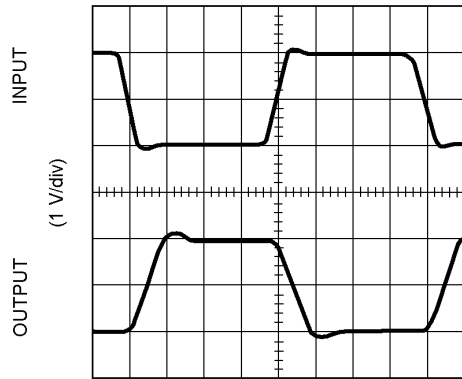

TIME (12.5 ns/div)

20016502

**Inverting Large Signal Pulse Response ( $V_S = \pm 5\text{V}$ )**

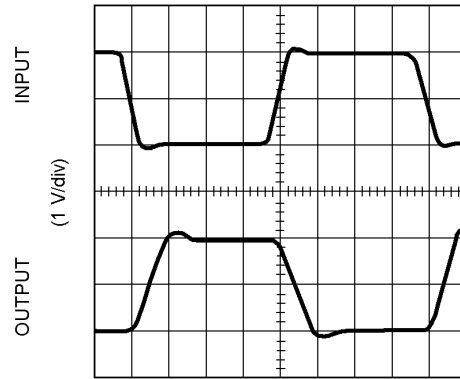

TIME (12.5 ns/div)

20016504

**Non-Inverting Large Signal Pulse Response ( $V_S = 5\text{V}$ )**

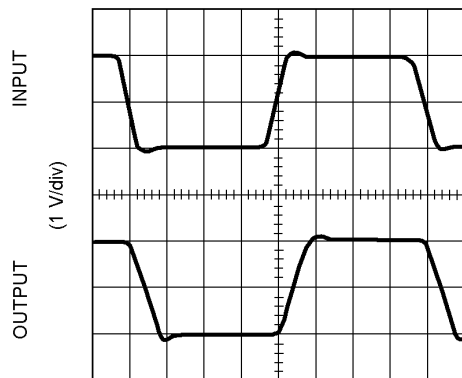

TIME (12.5 ns/div)

20016506

**Non-Inverting Large Signal Pulse Response ( $V_S = \pm 5\text{V}$ )**

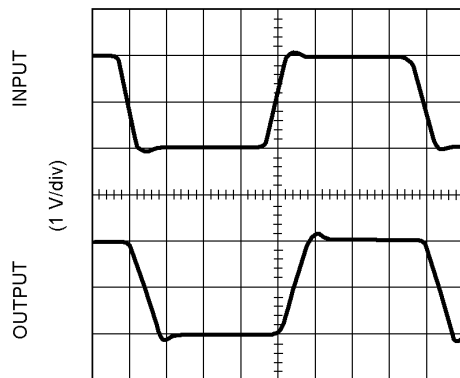

TIME (12.5 ns/div)

20016508

**Typical Performance Characteristics**  $T_J = 25^\circ\text{C}$ ,  $V^+ = \pm 5\text{V}$ ,  $V^- = -5$ ,  $R_F = 25\Omega$  for gain = +1,  $R_F = 402\Omega$  and for gain  $\geq +2$ , and  $R_L = 100\Omega$ , unless otherwise specified. (Continued)

**Non-Inverting Small Signal Pulse Response ( $V_S = 5\text{V}$ )**

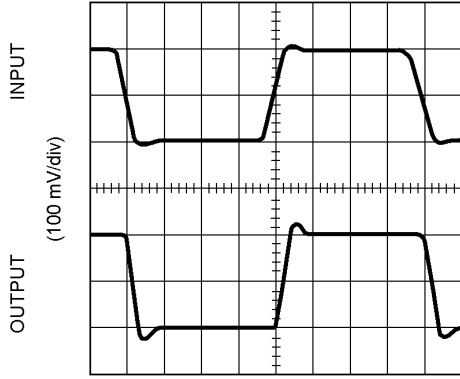

TIME (12.5 ns/div)

20016505

**Non-Inverting Small Signal Pulse Response ( $V_S = \pm 5\text{V}$ )**

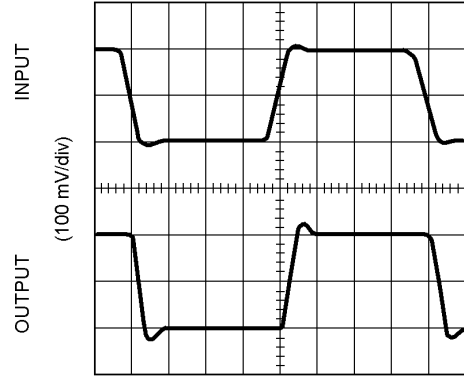

TIME (12.5 ns/div)

20016507

**Inverting Small Signal Pulse Response ( $V_S = 5\text{V}$ )**

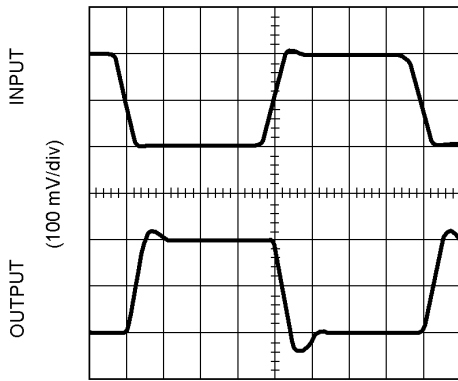

TIME (12.5 ns/div)

20016501

**Inverting Small Signal Pulse Response ( $V_S = \pm 5\text{V}$ )**

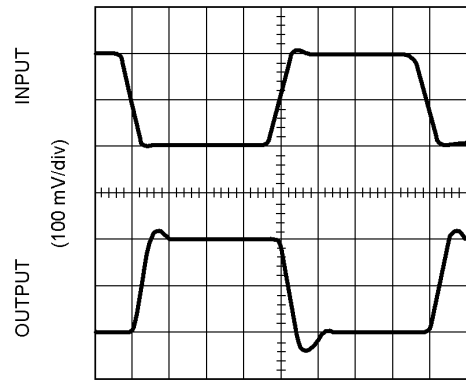

TIME (12.5 ns/div)

20016503

**Input Voltage and Current Noise vs. Frequency ( $V_S = 5\text{V}$ )**

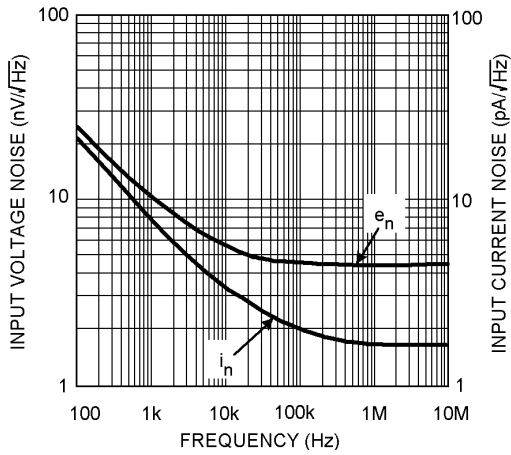

20016513

**Input Voltage and Current Noise vs. Frequency ( $V_S = \pm 5\text{V}$ )**

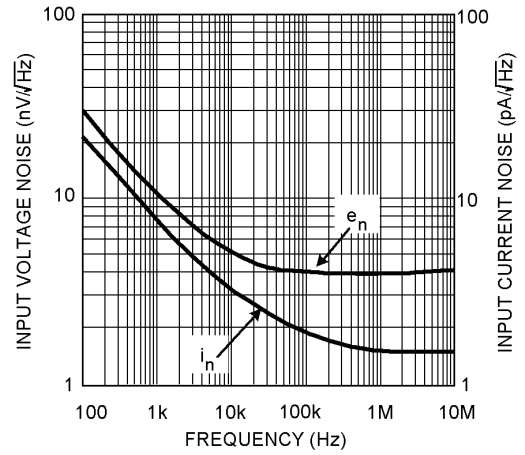

20016514



**Typical Performance Characteristics**  $T_J = 25^\circ\text{C}$ ,  $V^+ = \pm 5\text{V}$ ,  $V^- = -5$ ,  $R_F = 25\Omega$  for gain = +1,  $R_F = 402\Omega$  and for gain  $\geq +2$ , and  $R_L = 100\Omega$ , unless otherwise specified. (Continued)

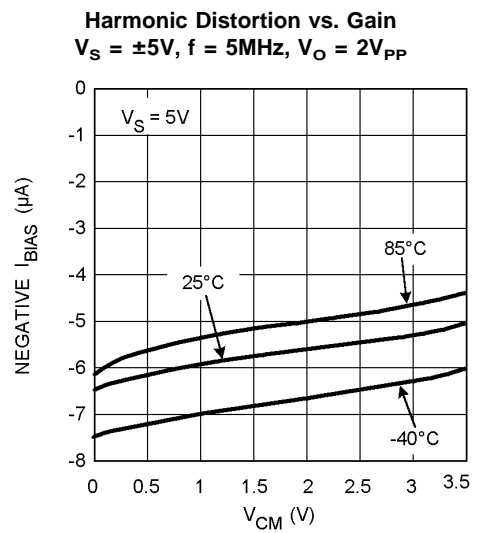
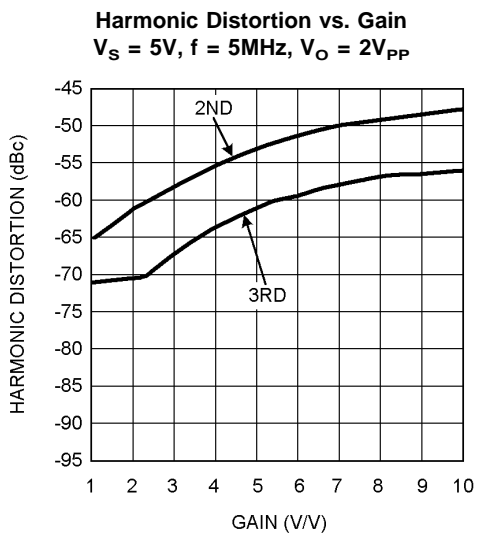
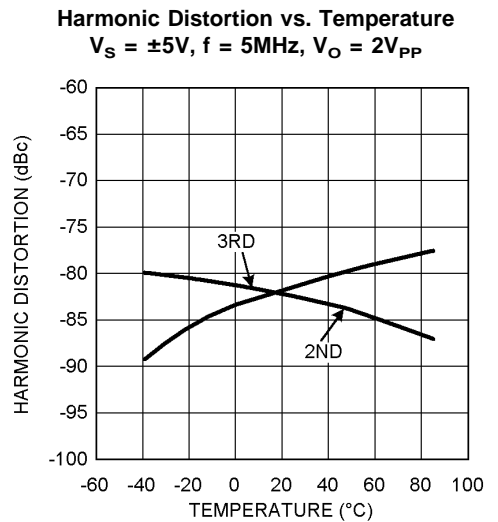
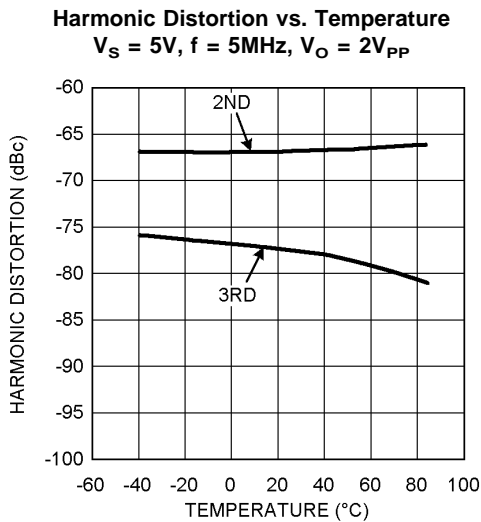
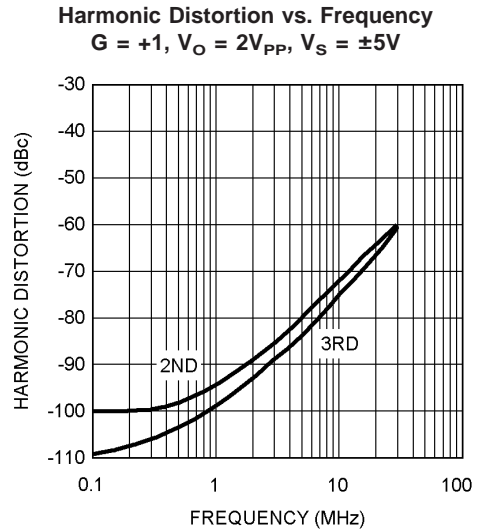
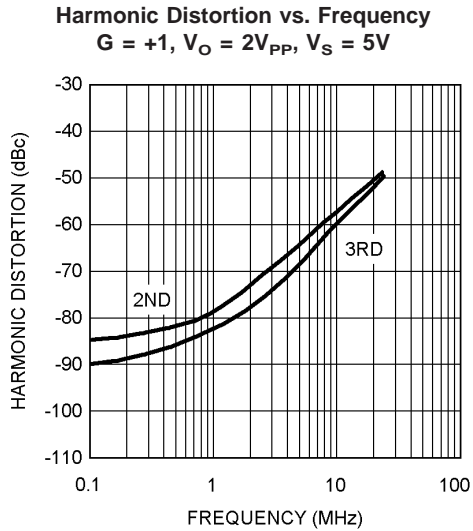

**Typical Performance Characteristics**  $T_J = 25^\circ\text{C}$ ,  $V^+ = \pm 5\text{V}$ ,  $V^- = -5$ ,  $R_F = 25\Omega$  for gain = +1,  $R_F = 402\Omega$  and for gain  $\geq +2$ , and  $R_L = 100\Omega$ , unless otherwise specified. (Continued)

**Harmonic Distortion vs. Output Swing**  
( $G = +2$ ,  $V_S = 5\text{V}$ ,  $f = 5\text{MHz}$ )

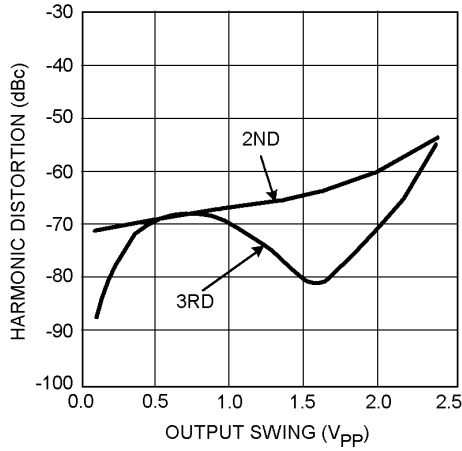

**Harmonic Distortion vs. Output Swing**  
( $G = +2$ ,  $V_S = \pm 5\text{V}$ ,  $f = 5\text{MHz}$ )

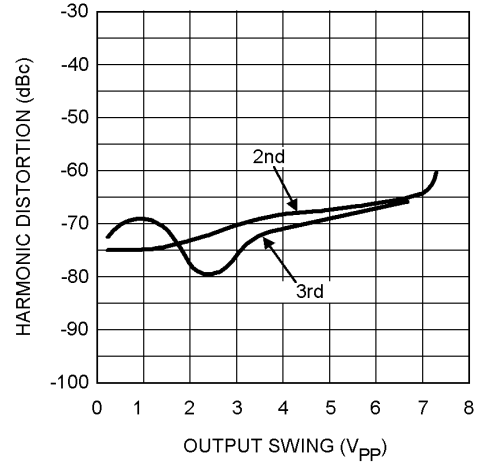

**PSRR vs. Frequency**

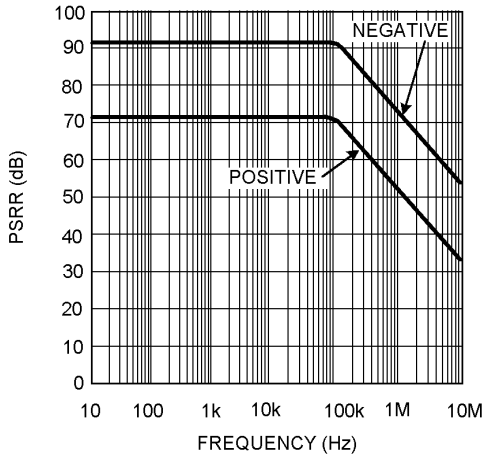

**CMRR vs. Frequency**

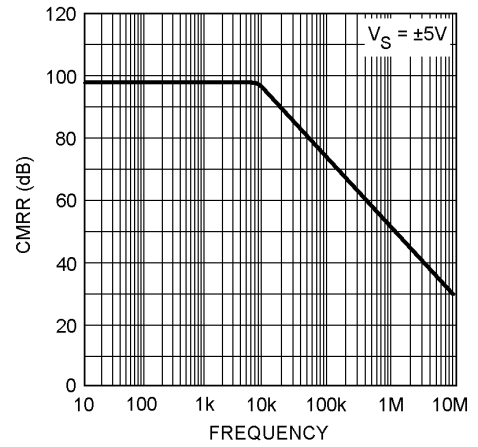

**Output Sinking Current**

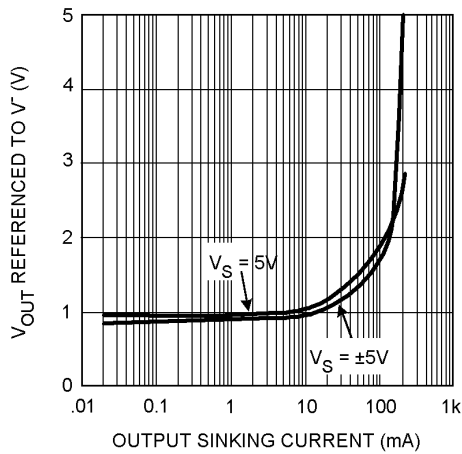

**Output Sourcing Current**

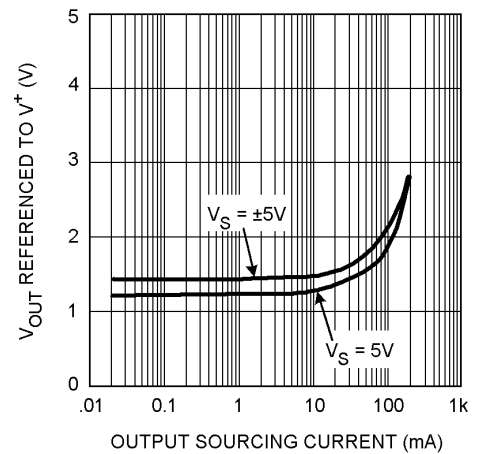

**Typical Performance Characteristics**  $T_J = 25^\circ\text{C}$ ,  $V^+ = \pm 5\text{V}$ ,  $V^- = -5$ ,  $R_F = 25\Omega$  for gain = +1,  $R_F = 402\Omega$  and for gain  $\geq +2$ , and  $R_L = 100\Omega$ , unless otherwise specified. (Continued)

**CrossTalk vs. Frequency (LMH6655 only)**

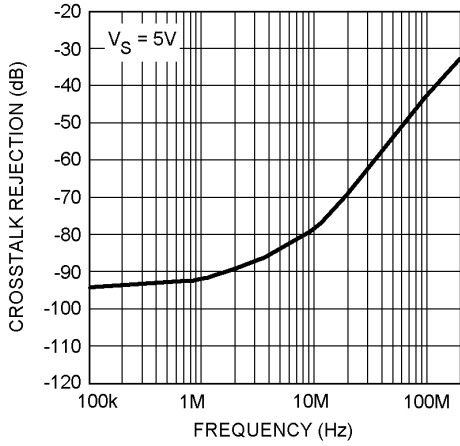

20016561

**CrossTalk vs. Frequency (LMH6655 only)**

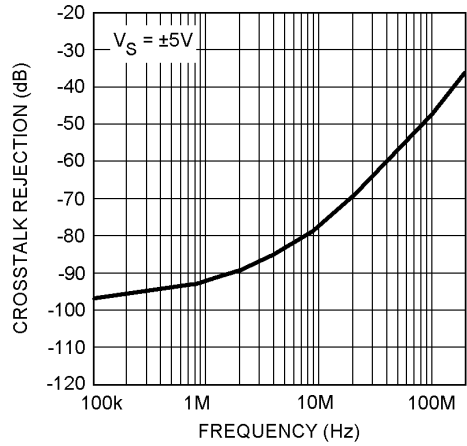

20016562

**Isolation Resistance vs. Capacitive Load**

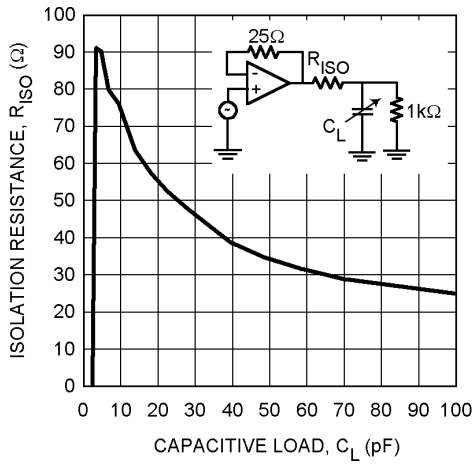

20016563

**Open Loop Gain and Phase vs. Frequency**

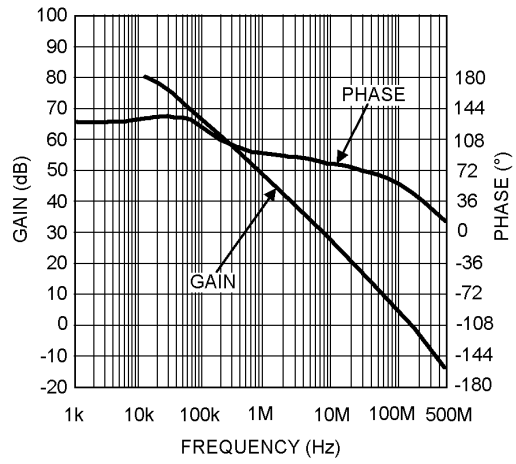

20016527

## Connection Diagrams

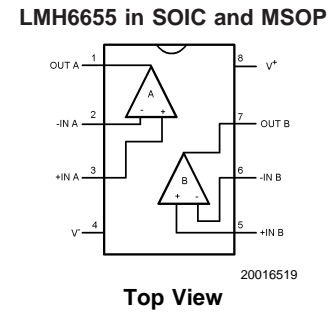
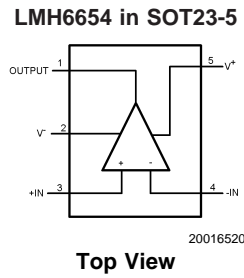
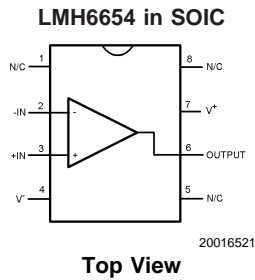

## Ordering Information

Package	Part Number	Package Marking	Transport Media	NSC Drawing
8-Pin SOIC	LMH6654MA	LMH6654MA	95 Units Rails	M08A
	LMH6654MAX		2.5k Units Tape and Reel	
	LMH6655MA	LMH6655MA	95 Units Rails	
	LMH6655MAX		2.5k Units Tape and Reel	
5-Pin SOT23-5	LMH6654MF	A66A	1k Units Tape and Reel	MF05A
	LMH6654MFX		3K Units Tape and Reel	
8-Pin MSOP	LMH6655MM	A67A	1k Units Tape and Reel	MUA08A
	LMH6655MMX		3.5k Units Tape and Reel	

## Application Information

### General Information

The LMH6654 single and LMH6655 dual high speed, voltage feedback amplifiers are manufactured on National Semiconductor's new VIP10 (Vertically Integrated PNP) complementary bipolar process. These amplifiers can operate from  $\pm 2.5V$  to  $\pm 6V$  power supply. They offer low supply current, wide bandwidth, very low voltage noise and large output swing. Many of the typical performance plots found in the datasheet can be reproduced if  $50\Omega$  coax and  $50\Omega$   $R_{IN}/R_{OUT}$  resistors are used.

### Circuit Layout Consideration

With all high frequency devices, board layouts with stray capacitance have a strong influence on the AC performance. The LMH6654/55 are not exception and the inverting input and output pins are particularly sensitive to the coupling of parasitic capacitance to AC ground. Parasitic capacitances on the inverting input and output nodes to ground could cause frequency response peaking and possible circuit oscillation. Therefore, the power supply, ground traces and ground plan should be placed away from the inverting input and output pins. Also, it is very important to keep the parasitic capacitance across the feedback to an absolute minimum.

The PCB should have a ground plane covering all unused portion of the component side of the board to provide a low impedance path. All trace lengths should be minimized to reduce series inductance.

Supply bypassing is required for the amplifiers performance. The bypass capacitors provide a low impedance return current path at the supply pins. They also provide high frequency filtering on the power supply traces. It is recommended that a ceramic decoupling capacitor  $0.1\mu F$  chip should be placed with one end connected to the ground plane and the other side as close as possible to the power pins. An additional  $10\mu F$  tantalum electrolytic capacitor

should be connected in parallel, to supply current for fast large signal changes at the output.

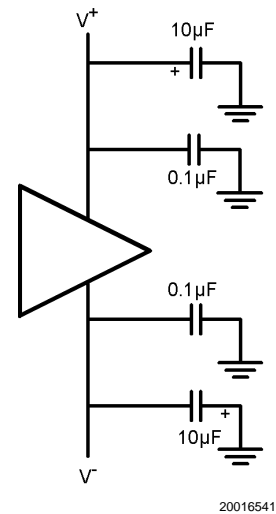

FIGURE 1.

### Evaluation Boards

National provides the following evaluation boards as a guide for high frequency layout and as an aid in device testing and characterization.

Device	Package	Evaluation Board PN
LMH6654MF	SOT23-5	CLC730068
LMH6654MA	8-Pin SOIC	CLC730027
LMH6655MA	8-Pin SOIC	CLC730036
LMH6655MM	8-Pin MSOP	CLC730123

## Application Information (Continued)

The free evaluation board are shipped automatically when a device sample request is placed with National Semiconductor.

The CLC730027 datasheet also contains tables of recommended components to evaluate several of National's high speed amplifiers. This table for the LMH6654 is illustrated below. Refer to the evaluation board datasheet for schematics and further information.

Components Needed to Evaluate the LMH6654 on the Evaluation Board:

- $R_f, R_g$  use the datasheet to select values.
- $R_{IN}, R_{OUT}$  typically 50Ω (Refer to the Basic Operation section of the evaluation board datasheet for details)
- $R_f$  is an optional resistor for inverting again configurations (select  $R_f$  to yield desired input impedance =  $R_g || R_f$ )
- $C_1, C_2$  use 0.1μF ceramic capacitors
- $C_3, C_4$  use 10μF tantalum capacitors

Components not used:

1.  $C_5, C_6, C_7, C_8$
2. R1 thru R8

The evaluation boards are designed to accommodate dual supplies. The board can be modified to provide single operation. For best performance;

- 1) do not connect the unused supply.
- 2) ground the unused supply pin.

### power Dissipation

The package power dissipation should be taken into account when operating at high ambient temperature and/or high power dissipative conditions. In determining maximum operable temperature of the device, make sure the total power dissipation of the device is considered; this power dissipated in the device with a load connected to the output as well as the nominal dissipation of the op amp.

### Driving Capacitive Loads

Capacitive loads decrease the phase margin of all op amps. The output impedance of a feedback amplifier becomes inductive at high frequencies, creating a resonant circuit when the load is capacitive. This can lead to overshoot, ringing and oscillation. To eliminate oscillation or reduce ringing, an isolation resistor can be placed as shown in *Figure 2* below. At frequencies above

$$F = \frac{1}{2 \pi R_{ISO} C_{LOAD}}$$

the load impedance of the Amplifier approaches  $R_{ISO}$ . The desired performance depends on the value of the isolation resistor. The isolation resistance vs. capacitance load graph in the typical performance characteristics provides the means for selection of the value of  $R_s$  that provides  $\leq 3$ dB peaking in closed loop  $A_V = 1$  response. In general, the bigger the isolation resistor, the more damped the pulse response becomes. For initial evaluation, a 50Ω isolation resistor is recommended.

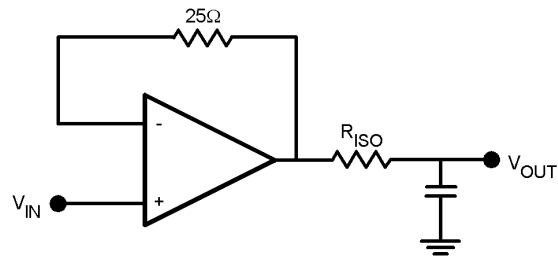

20016540

FIGURE 2.

### Components Selection and Feedback Resistor

It is important in high-speed applications to keep all component leads short since wires are inductive at high frequency. For discrete components, choose carbon composition axially leaded resistors and micro type capacitors. Surface mount components are preferred over discrete components for minimum inductive effect. Never use wire wound type resistors in high frequency applications.

Large values of feedback resistors can couple with parasitic capacitance and cause undesired effects such as ringing or oscillation in high-speed amplifiers. Keep resistors as low as possible consistent with output loading consideration. For a gain of 2 and higher, 402Ω feedback resistor used for the typical performance plots gives optimal performance. For unity gain follower, a 25Ω feedback resistor is recommended rather than a direct short. This effectively reduces the Q of what would otherwise be a parasitic inductance (the feedback wire) into the parasitic capacitance at the inverting input.

### Bias Current Cancellation

In order to cancel the bias current errors of the non-inverting configuration, the parallel combination of the gain setting  $R_g$  and feedback  $R_f$  resistors should equal the equivalent source resistance  $R_{seq}$  as defined in *Figure 3*. Combining this constraint with the non-inverting gain equation, allows both  $R_f$  and  $R_g$  to be determined explicitly from the following equations:

$$R_f = A_V R_{seq} \text{ and } R_g = R_f / (A_V - 1)$$

For inverting configuration, bias current cancellation is accomplished by placing a resistor  $R_b$  on the non-inverting input equal in value to the resistance seen by the inverting input ( $R_f / (R_g + R_s)$ ). The additional noise contribution of  $R_b$  can be minimized through the use of a shunt capacitor.

Application Information (Continued)

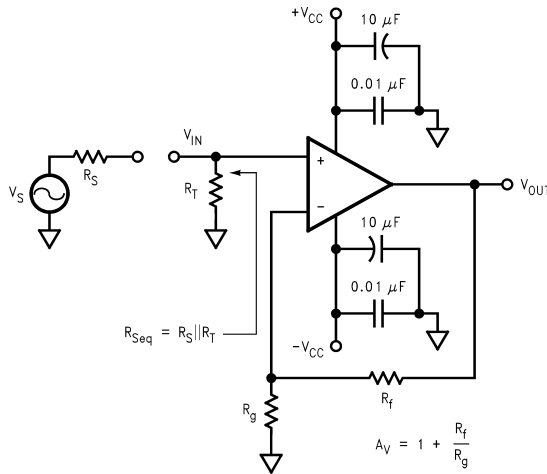

20016542

FIGURE 3. Non-Inverting Amplifier Configuration

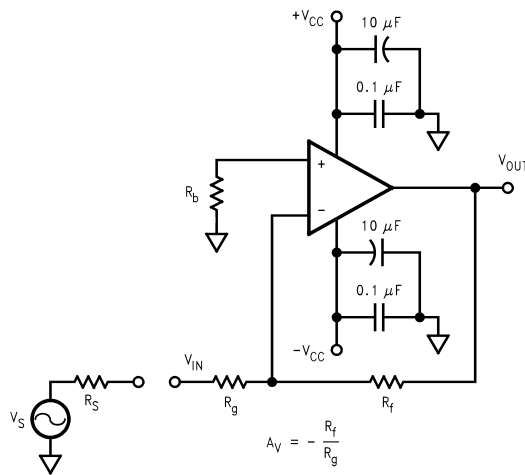

20016543

FIGURE 4. Inverting Amplifier Configuration

Total Input Noise vs. Source Resistance

The noise model for the non-inverting amplifier configuration showing all noise sources is described in Figure 5. In addition to the intrinsic input voltage noise ( $e_n$ ) and current noise ( $i_n = i_{n+} = i_{n-}$ ) sources, there also exists thermal voltage noise  $e_t = \sqrt{4kTR}$  associated with each of the external resistors. Equation 1 provides the general form for total equivalent input voltage noise density ( $e_{ni}$ ). Equation 2 is a simplification of Equation 1 that assumes

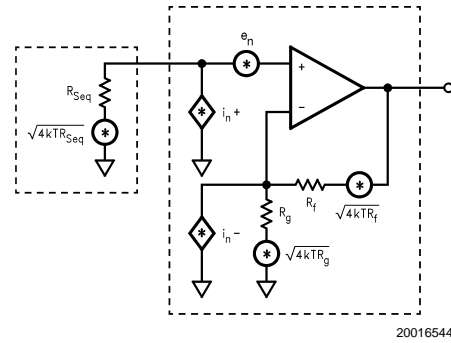

20016544

FIGURE 5. Non-Inverting Amplifier Noise Model

$$e_{ni} = \sqrt{e_n^2 + (i_n + R_{seq})^2 + 4kTR_{seq} + (i_n - (R_f || R_g))^2 + 4kT(R_f || R_g)} \quad (1)$$

$R_f || R_g = R_{seq}$  for bias current cancellation. Figure 6 illustrates the equivalent noise model using this assumption. The total equivalent output voltage noise ( $e_{no}$ ) is  $e_{ni} * A_V$ .

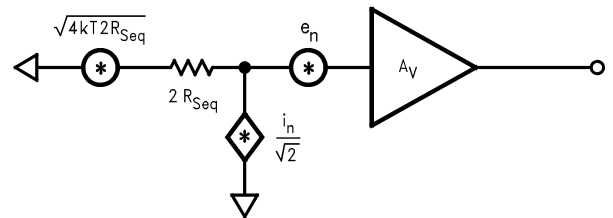

20016545

FIGURE 6. Noise Model with  $R_f || R_g = R_{seq}$

$$e_{ni} = \sqrt{e_n^2 + 2(i_n R_{seq})^2 + 4kT(2R_{seq})} \quad (2)$$

If bias current cancellation is not a requirement, then  $R_f || R_g$  does not need to equal  $R_{seq}$ . In this case, according to Equation 1,  $R_f R_g$  should be as low as possible in order to minimize noise. Results similar to Equation 1 are obtained for the inverting configuration on Figure 2 if  $R_{seq}$  is replaced by  $R_b$  and  $R_g$  is replaced by  $R_g + R_s$ . With these substitutions, Equation 1 will yield an  $e_{ni}$  referred to the non-inverting input. Referring to  $e_{ni}$  to the inverting input is easily accomplished by multiplying  $e_{ni}$  by the ratio of non-inverting to inverting gains.

Noise Figure

Noise Figure (NF) is a measure of the noise degradation caused by an amplifier.

$$NF = 10 \text{ LOG } \left[ \frac{S_i/N_i}{S_o/N_o} \right] = 10 \text{ LOG } \left[ \frac{e_{ni}^2}{e_t^2} \right] \quad (3)$$

The noise figure formula is shown in Equation 3. The addition of a terminating resistor  $R_T$ , reduces the external thermal noise but increases the resulting NF.

## Application Information (Continued)

The NF is increased because the  $R_T$  reduces the input signal amplitude thus reducing the input SNR.

$$NF = 10 \text{ LOG} \left[ \frac{e_n^2 + i_n^2 (R_{seq} + (R_f \parallel R_g))^2 + 4KTR_{seq} + 4kt (R_f \parallel R_g)}{4kTR_{seq}} \right] \quad (4)$$

The noise figure is related to the equivalent source resistance ( $R_{seq}$ ) and the parallel combination of  $R_f$  and  $R_g$ . To minimize noise figure, the following steps are recommended:

1. Minimize  $R_f \parallel R_g$
2. Choose the Optimum  $R_s$  ( $R_{OPT}$ )

$R_{OPT}$  is the point at which the NF curve reaches a minimum and is approximated by:

$$R_{OPT} \approx (e_n/i_n)$$

**Physical Dimensions** inches (millimeters) unless otherwise noted

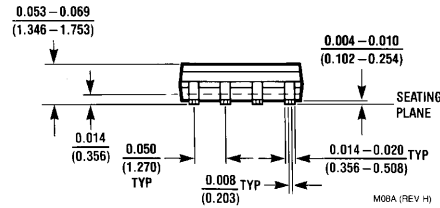
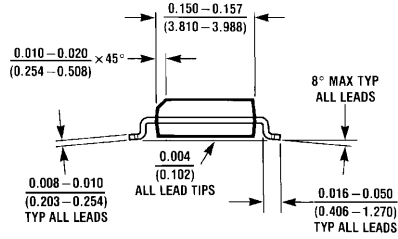
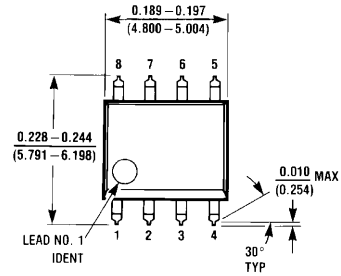

**8-Pin SOIC**  
**NS Package Number M08A**

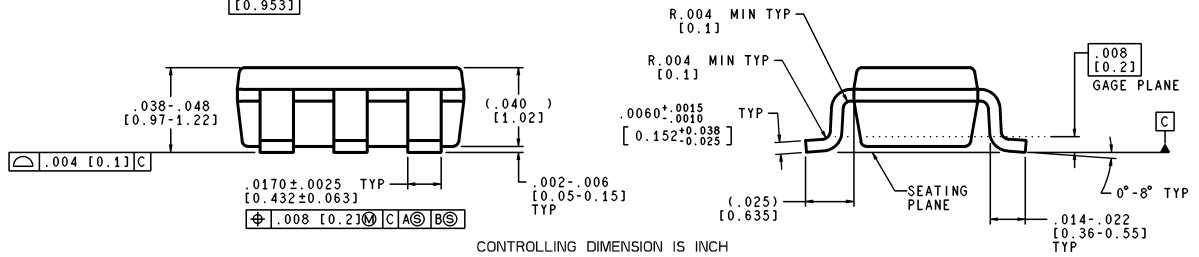
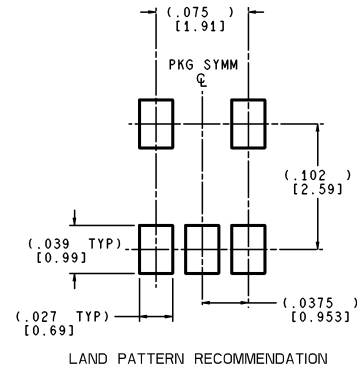
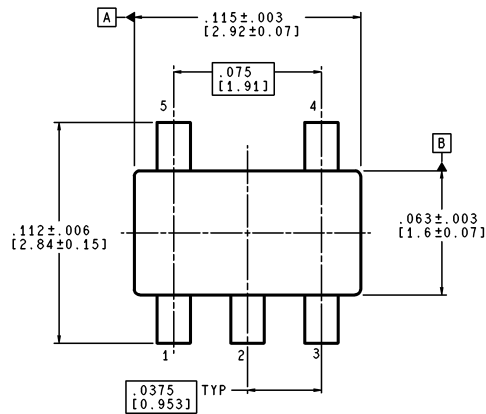

CONTROLLING DIMENSION IS INCH  
VALUES IN [ ] ARE MILLIMETERS

**5-Pin SOT23**  
**NS Package Number MF05A**

MF05A (Rev A)



**Physical Dimensions** inches (millimeters) unless otherwise noted (Continued)

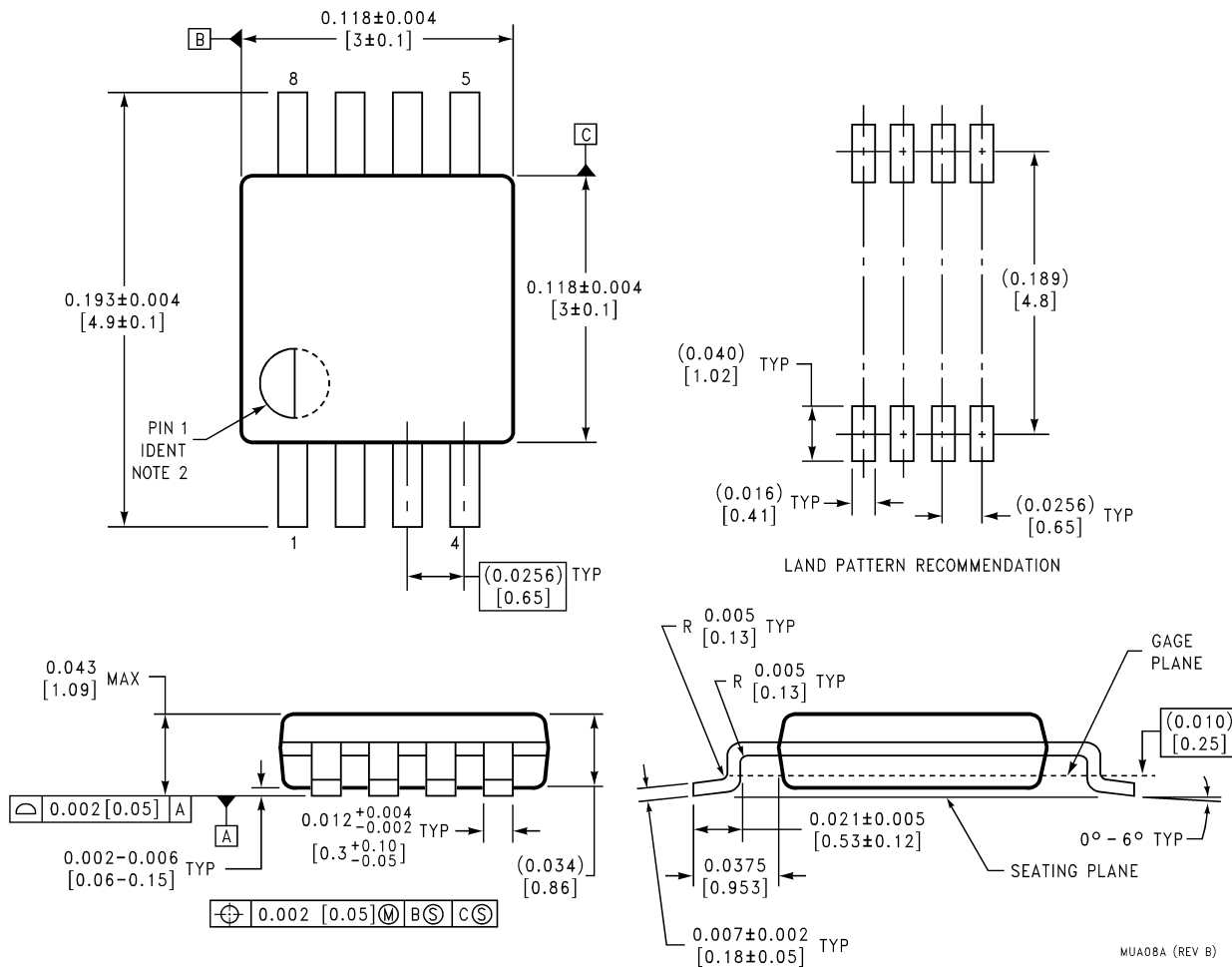

**LIFE SUPPORT POLICY**

NATIONAL'S PRODUCTS ARE NOT AUTHORIZED FOR USE AS CRITICAL COMPONENTS IN LIFE SUPPORT DEVICES OR SYSTEMS WITHOUT THE EXPRESS WRITTEN APPROVAL OF THE PRESIDENT AND GENERAL COUNSEL OF NATIONAL SEMICONDUCTOR CORPORATION. As used herein:

1. Life support devices or systems are devices or systems which, (a) are intended for surgical implant into the body, or (b) support or sustain life, and whose failure to perform when properly used in accordance with instructions for use provided in the labeling, can be reasonably expected to result in a significant injury to the user.
2. A critical component is any component of a life support device or system whose failure to perform can be reasonably expected to cause the failure of the life support device or system, or to affect its safety or effectiveness.

**National Semiconductor Corporation**  
Americas  
Email: support@nsc.com

**National Semiconductor Europe**  
Fax: +49 (0) 180-530 85 86  
Email: europe.support@nsc.com  
Deutsch Tel: +49 (0) 69 9508 6208  
English Tel: +44 (0) 870 24 0 2171  
Français Tel: +33 (0) 1 41 91 8790

**National Semiconductor Asia Pacific Customer Response Group**  
Tel: 65-2544466  
Fax: 65-2504466  
Email: ap.support@nsc.com

**National Semiconductor Japan Ltd.**  
Tel: 81-3-5639-7560  
Fax: 81-3-5639-7507

www.national.com