

LMS5213

80mA, μ Cap, Low Dropout Voltage Regulator in SC70

General Description

The LMS5213 is a μ Cap, low dropout voltage regulator with very low quiescent current, 220 μ A typical, at 80mA load. It also has very low dropout voltage, typically 20mV at light load and 330mV at 80mA.

The LMS5213 provides up to 80mA and consumes a typical of 1 μ A in disable mode.

The LMS5213 is optimized to work with low value, low cost ceramic capacitors. The output typically require only 0.47 μ F of output capacitance for stability. The enable pin can be tied to V_{IN} for easy device layout.

The LMS5213 is designed for portable, battery powered equipment applications with small space requirements.

The LMS5213 is available in a space saving 5-pin SC70 package. Performance is specified for the -40°C to $+125^{\circ}\text{C}$ temperature range and is available in 2.8V, 3.0V and 3.3V fixed voltages. For other output voltage options, please contact National Semiconductor.

Features

- Space saving SC70 package
- Available in 2.8V, 3.0V, and 3.3V fixed voltages
- Guaranteed 80mA output
- Low quiescent current
- Low dropout voltage
- Low temperature coefficient
- Current and thermal limiting
- Logic-controlled shutdown
- Stability with low-ESR ceramic capacitors
- Pin-to-pin replacement for MicTM 5213

Applications

- Cellular Phones
- Battery-powered equipment
- Bar code scanner
- Laptop/palmtop computer
- High-efficiency linear power supplies

Typical Application

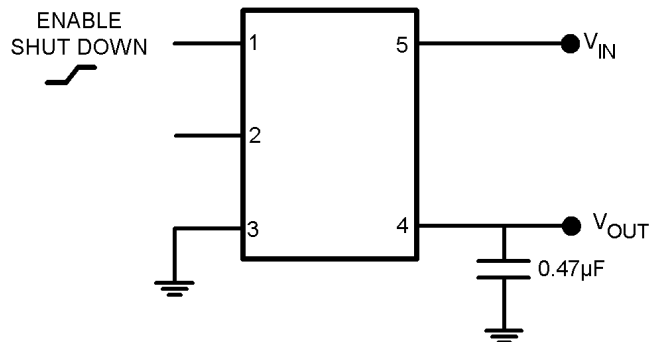

20010919

Simplified Schematic

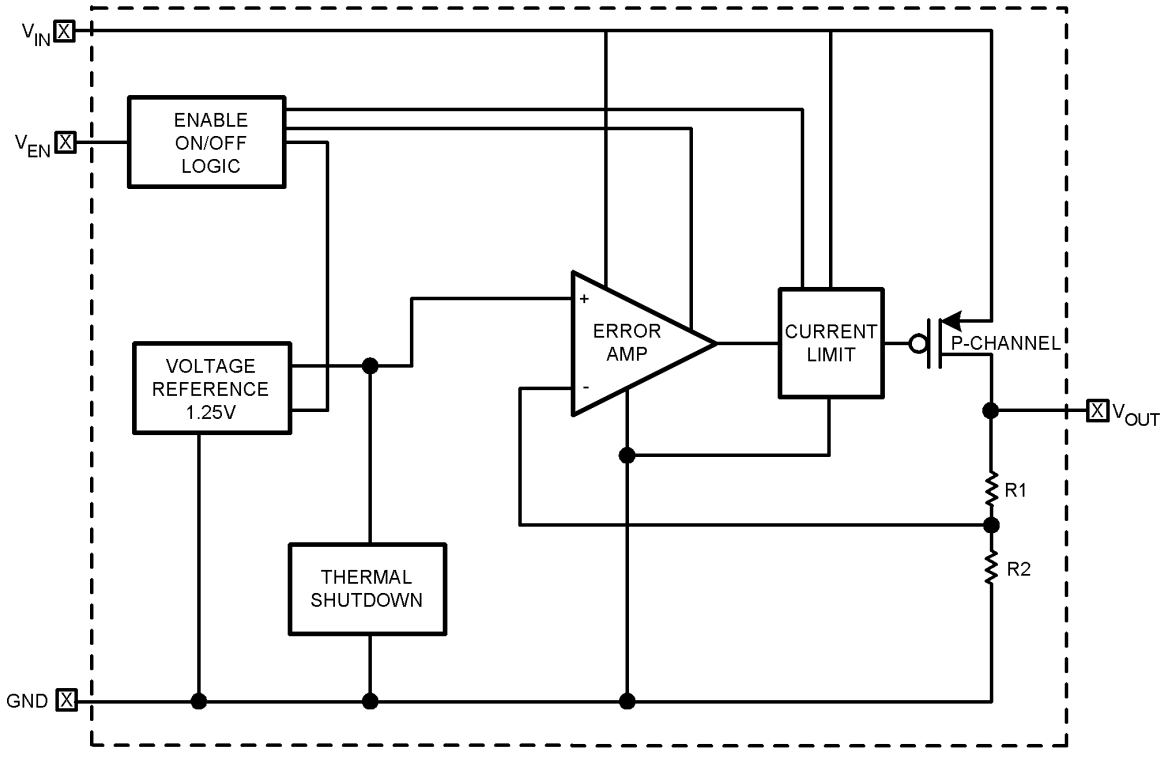

20010911

Pin Description

Pin Number	Pin Name	Pin Function
1	V_{EN}	Enable Input Logic, Logic High = Enabled Logic Low = Shutdown
2	NC	Not internally connected
3	GND	Ground
4	V_{OUT}	Output Voltage
5	V_{IN}	Input Voltage

Connection Diagram

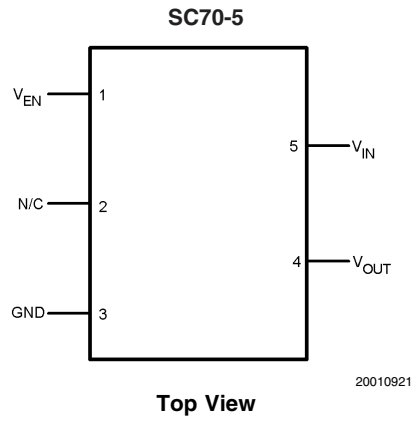

Ordering Information

Package	Part Number	Package Marking	Transport Media	NSC Drawing
5-Pin SC70	LMS5213IM7-2.8	L0E	1k Units Tape and Reel	MAA05A
	LMS5213IM7X-2.8		3k Units Tape and Reel	
	LMS5213IM7-3.0	L1E	1k Units Tape and Reel	
	LMS5213IM7X-3.0		3k Units Tape and Reel	
	LMS5213IM7-3.3	L2E	1k Units Tape and Reel	
	LMS5213IM7X-3.3		3k Units Tape and Reel	

Absolute Maximum Ratings (Note 1)

If Military/Aerospace specified devices are required, please contact the National Semiconductor Sales Office/Distributors for availability and specifications.

ESD Tolerance (Note 2)	
Human Body Model	2000V
Junction Temperature	150°C
V_{IN} , V_{OUT} , V_{EN}	-0.3 TO 6.5V
Soldering Information	
Infrared or Convection (20 sec)	235°C
Wave Soldering (10 sec)	260°C (lead temp)

Operating Ratings

Supply Voltages

V_{IN}	2.7V to 6V
V_{EN}	0V to V_{IN}
Junction Temp. Range (Note 3)	-40°C to +125°C
Storage Temperature Range	-65°C to 150°C
Package Thermal Resistance	
SC70-5	478°C/W

Electrical Characteristics

Unless otherwise specified, all limits guaranteed for $T_J = 25^\circ\text{C}$, $V_{IN} = V_{OUT} + 1\text{V}$, $I_L = 1\text{mA}$, $C_L = 0.47\mu\text{F}$, $V_{EN} \geq 2.0\text{V}$. **Bold-face** limits apply at the temperature extremes.

Symbol	Parameter	Conditions	Min (Note 5)	Typ (Note 4)	Max (Note 5)	Units
V_O	Output Voltage Accuracy		-3 -4		3 4	%
$\Delta V_O/\Delta T$	Output Voltage Temp. Coefficient	(Note 10)		50	200	ppm/°C
$\Delta V_O/V_O$	Line Regulation	$V_{IN} = V_{OUT} + 1\text{V}$ to 6V		0.008	0.3 0.5	%
$\Delta V_O/V_O$	Load Regulation	$I_L = 0.1\text{mA}$ to 80mA (Note 6)		0.08	0.3 0.5	%
$V_{IN}-V_O$	Dropout Voltage (Note 7)	$I_L = 100\mu\text{A}$		20		mV
		$I_L = 20\text{mA}$		70	350	
		$I_L = 50\text{mA}$		180		
		$I_L = 80\text{mA}$		330	600	
I_Q	Quiescent Current	$V_{EN} \leq 0.4\text{V}$ (Shutdown)		1	10	μA
I_{GND}	Ground Pin Current	$I_L = 100\mu\text{A}$, $V_{EN} \geq 2.0\text{V}$ (active)		160		μA
		$I_L = 20\text{mA}$, $V_{EN} \geq 2.0\text{V}$ (active)		180	750	
		$I_L = 50\text{mA}$, $V_{EN} \geq 2.0\text{V}$ (active)		200		
		$I_L = 80\text{mA}$, $V_{EN} \geq 2.0\text{V}$ (active)		220	3000	
I_{GNDDO}	Ground Pin Current at Dropout, (Note 8)	$V_{IN} = V_{OUT(NOMINAL)} - 0.5\text{V}$		200	300	μA
I_{LIMIT}	Current Limit	$V_{OUT} = 0\text{V}$		180	250	mA
$\Delta V_O/\Delta P_D$	Thermal Regulation	(Note 9)		0.05		%W

Enable Input

V_{IL}	Enable Input Voltage Level	Logic Low (off)			0.6	V
V_{IH}		Logic High (on)	2.0			V
I_{IL}	Enable Input Current	$V_{IL} \leq 0.6\text{V}$		0.01	1	μA
I_{IH}		$V_{IH} \geq 2.0\text{V}$		15	50	μA

Note 1: Absolute Maximum Ratings indicate limits beyond which damage to the device may occur. Operating Ratings indicate conditions for which the device is intended to be functional, but specific performance is not guaranteed. For guaranteed specifications and the test conditions, see the Electrical Characteristics.

Note 2: Human body model, 1.5k Ω in series with 100pF.

Note 3: The maximum power dissipation is a function of $T_{J(max)}$, θ_{JA} , and T_A . The maximum allowable power dissipation at any ambient temperature is $P_D = (T_{J(max)} - T_A)/\theta_{JA}$. All numbers apply for packages soldered directly into a PC board.

Note 4: Typical Values represent the most likely parametric norm.

Note 5: All limits are guaranteed by testing or statistical analysis.

Note 6: Regulation is measured at constant junction temperature using low duty cycle pulse testing. Changes in output voltage due to heating effects are covered by the thermal regulation specification.

Note 7: Dropout voltage is defined as the input to output differential at which the output voltage drops 2% below its nominal value measured at 1V differential.

Note 8: Ground pin current is the regulator quiescent current plus pass transistor base current. The total current drawn from the supply is the sum of the load current plus the ground pin current.

Electrical Characteristics (Continued)

Note 9: Thermal regulation is defined as the change in output voltage at a time “t” after a change in power dissipation is applied, excluding load or line regulation effects. Specifications are for an 80mA load pulse at $V_{IN} = 6V$ for $t = 16ms$.

Note 10: Output voltage temperature coefficient is defined as the worst-case voltage change divided by the total temperature range.

Typical Characteristics Unless otherwise specified, $T_A = 25^\circ C$, $V_{OUT} = 2.8V$, $C_L = 0.47\mu F$

Dropout Voltage vs. Output Current

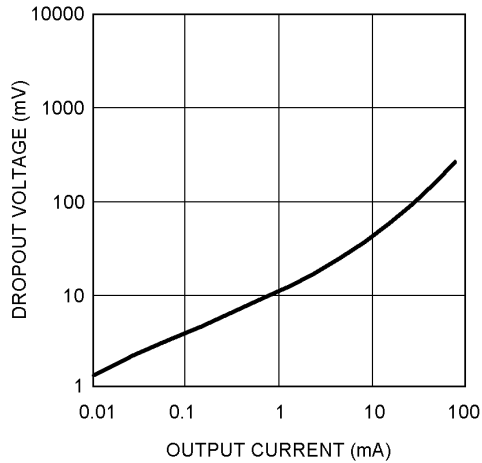

20010912

Dropout Voltage vs. Temperature

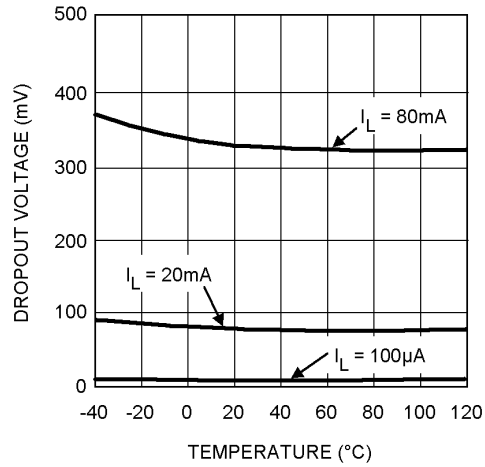

20010901

Dropout Characteristics

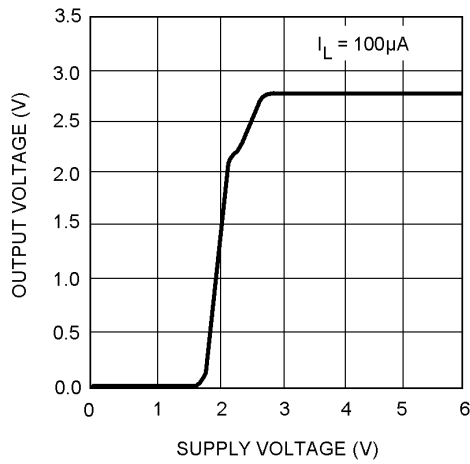

20010906

Dropout Characteristics

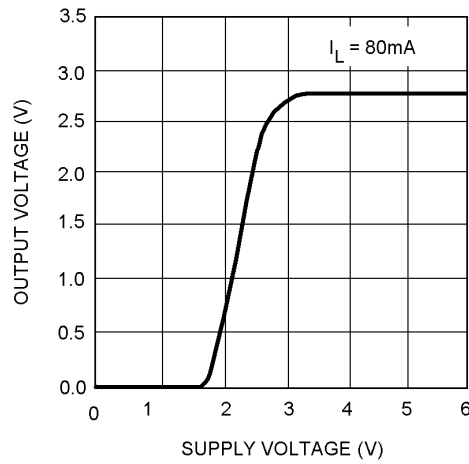

20010907

Typical Characteristics Unless otherwise specified, $T_A = 25^\circ\text{C}$, $V_{\text{OUT}} = 2.8\text{V}$, $C_L = 0.47\mu\text{F}$ (Continued)

Ground Current vs. Output Current

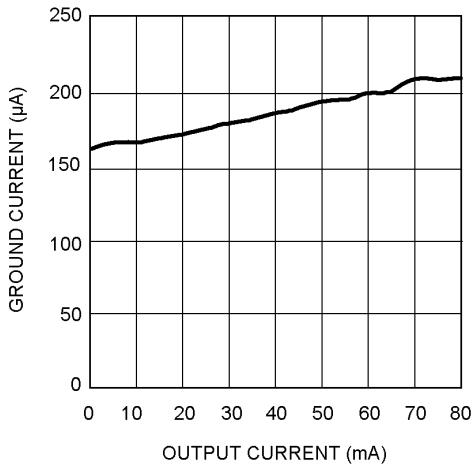

20010903

Ground Current vs. Supply Voltage

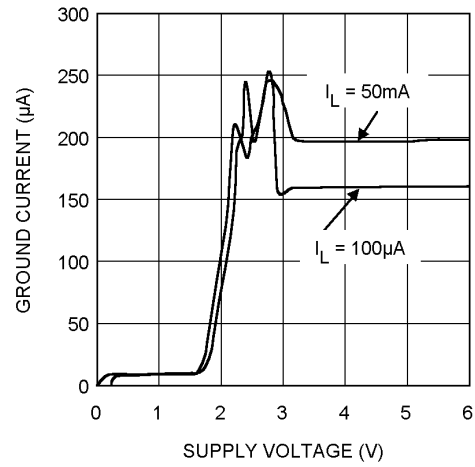

20010904

Ground Current vs. Temperature

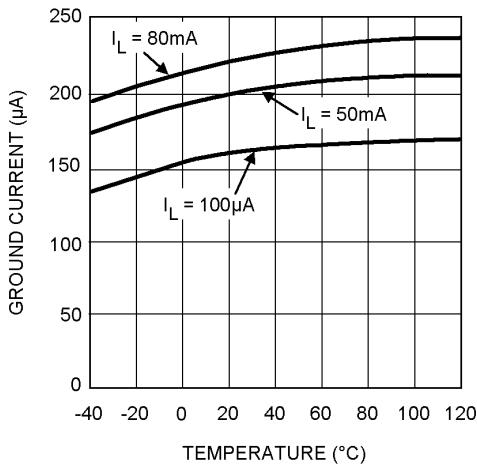

20010913

Short Circuit Current vs. Input Voltage

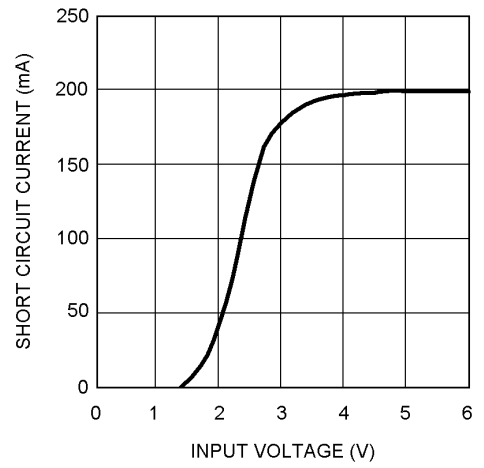

20010905

Output Voltage vs. Temperature

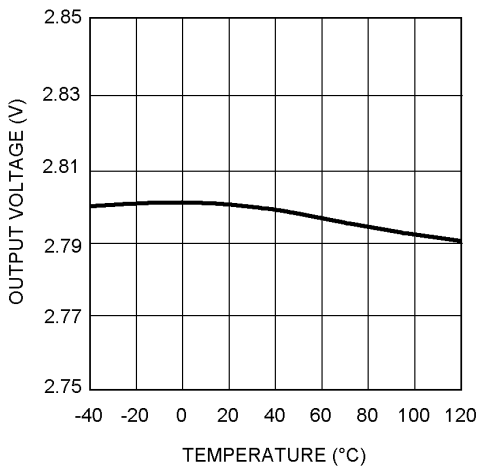

20010902

Load Transient

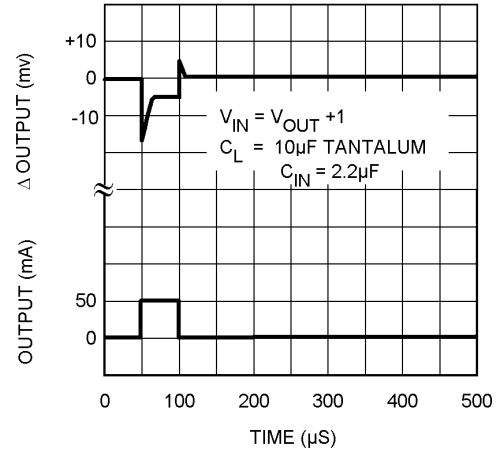

20010914

Typical Characteristics Unless otherwise specified, $T_A = 25^\circ\text{C}$, $V_{OUT} = 2.8\text{V}$, $C_L = 0.47\mu\text{F}$ (Continued)

Load Transient

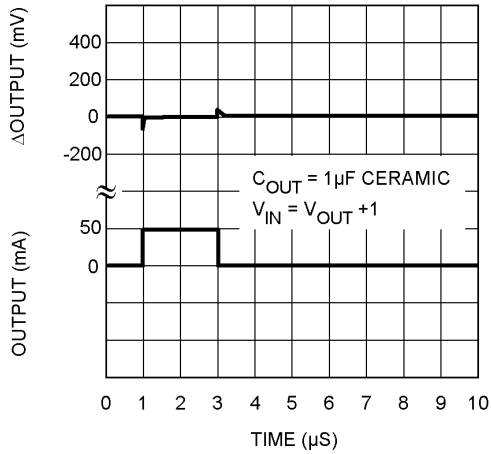

20010916

Line Transient

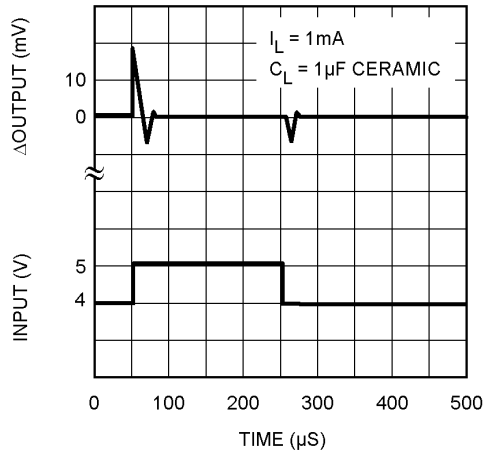

20010917

Line Transient

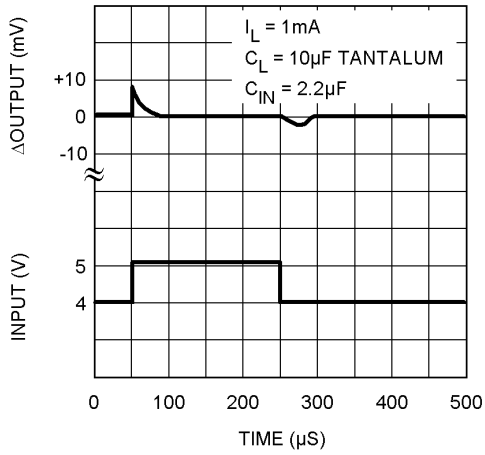

20010918

Ripple Voltage vs. Frequency

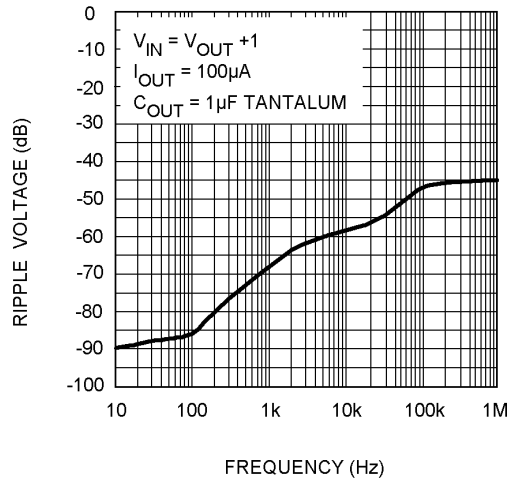

20010908

Ripple Voltage vs. Frequency

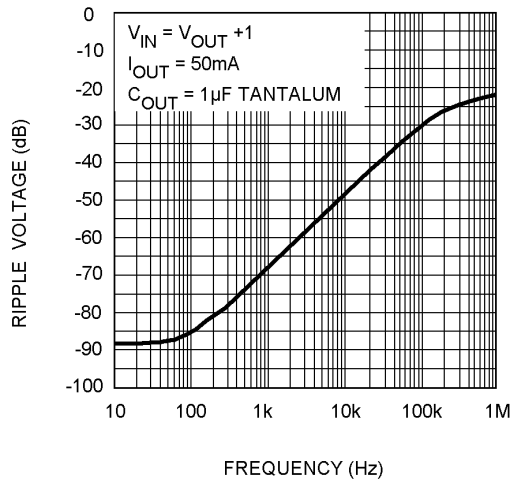

20010909

Noise Characteristics

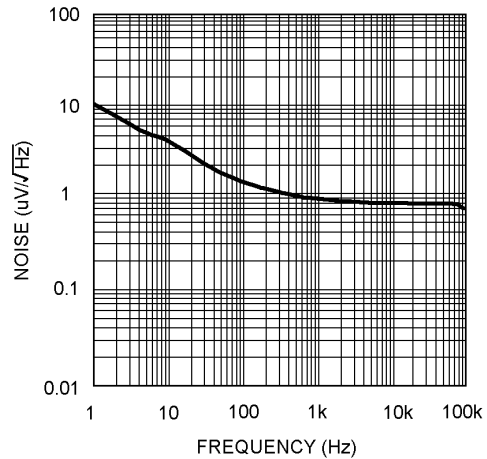

20010910

Typical Characteristics

Unless otherwise specified, $T_A = 25^\circ\text{C}$, $V_{\text{OUT}} = 2.8\text{V}$, $C_L = 0.47\mu\text{F}$ (Continued)

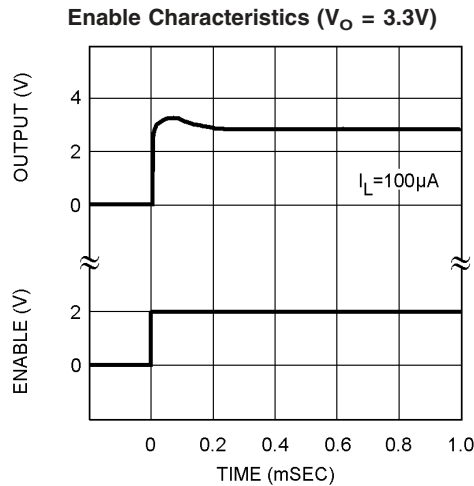

20010923

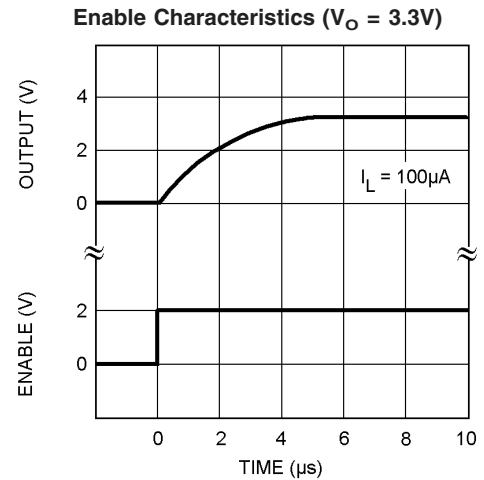

20010924

Application Information

The LMS5213 is a low dropout, linear regulator designed primarily for battery-powered applications. The LMS5213 can be used with low cost ceramic capacitors, typical value of $0.47\mu\text{F}$.

As illustrated in the simplified schematics, the LMS5213 consists of a 1.25V reference, error amplifier, P-channel pass transistor and internal feedback voltage divider. The 1.25V reference is connected to the input of the error amp. The error amp compares this reference with the feedback voltage. If the feedback voltage is lower than the reference, the pass transistor gate is pulled lower allowing more current to pass and increasing the output voltage. If the feedback voltage is too high, the pass transistor gate is pulled up allowing less current to pass to the output. The output voltage is feedback through the resistor divider. Additional blocks include short circuit current protection and thermal protection.

The LMS5213 features an 80mA P-channel MOSFET transistor. This provides several advantages over similar designs using PNP pass transistors including longer battery life.

The P-channel MOSFET requires no base drive, which reduces quiescent current considerably. PNP based regulators waste considerable amounts of current in dropout when the pass transistor saturates. They also have high base drive currents under large loads. The LMS5213 does not suffer from these problems and consumes only the specified quiescent current under light and heavy loads.

External Capacitors

Like any low-dropout regulators, the LMS5213 requires external capacitors for regulator stability. The LMS5213 is specially designed for portable applications requiring minimum board space and the smallest components.

A $0.1\mu\text{F}$ capacitor should be placed from V_{IN} to GND if there is more than 10 inches of wire between the input and AC filter or when a battery is used as the input. This capacitor must be located a distance of not more than 1cm from the input pin and returned to a clean analog ground.

The LMS5213 is designed to work with small ceramic output capacitors. Ceramic capacitors ranging between $0.47\mu\text{F}$ to $4.7\mu\text{F}$ are the smallest and least expensive.

No-Load Stability

The LMS5213 will remain stable and in regulation with no-load (other than the internal voltage divider). This is especially important in CMOS RAM keep-alive applications.

Enable Input

The LMS5213 is shut off by pulling the V_{EN} pin below 0.6V ; all internal circuitry is powered off and the quiescent current is typically $1\mu\text{A}$. Pulling the V_{EN} high above 2V re-enables the device and allows operation. If the shut down feature is not used, the V_{EN} pin should be tied to V_{IN} to keep the regulator output on all the time.

Thermal Behavior

The LMS5213 regulator has internal thermal shutdown to protect the device from over heating. Under all operating conditions, the maximum junction temperature of the LMS5213 must be below 125°C . Maximum power dissipation can be calculated based on the output current and the voltage drop across the part. The maximum power dissipation is

$$P_{\text{D(MAX)}} = (T_{\text{J(MAX)}} - T_{\text{A}}) / \theta_{\text{JA}}$$

θ_{JA} is the junction-to-ambient thermal resistance, 478°C/W for the LMS5213 in the SC70 package. T_{A} is the maximum ambient temperature $T_{\text{J(MAX)}}$ is the maximum junction temperature of the die, 125°C

When operating the LMS5213 at room temperature, the maximum power dissipation is 209mW .

The actual power dissipated by the regulator is

$$P_{\text{D}} = (V_{\text{IN}} - V_{\text{OUT}}) I_{\text{L}} + V_{\text{IN}} I_{\text{GND}}$$

The figure below shows the voltage and currents, which are present in the circuit.

Application Information (Continued)

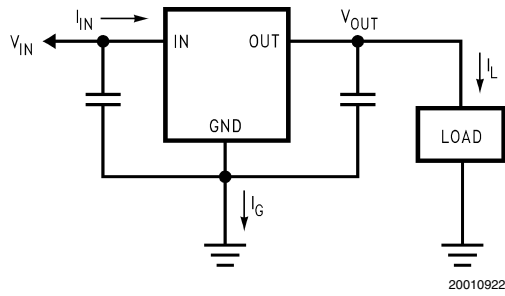

FIGURE 1. Power Dissipation Diagram

Substituting $P_{D(MAX)}$, determined above, for P_D and solving for the operating condition that are critical to the application will give the maximum operating conditions for the regulator circuit. To prevent the device from entering thermal shut-down, maximum power dissipation cannot be exceeded.

Fixed Voltage Regulator

The LMS5213 offers a smaller system solution that is ideal for general-purpose voltage regulation in any handheld device.

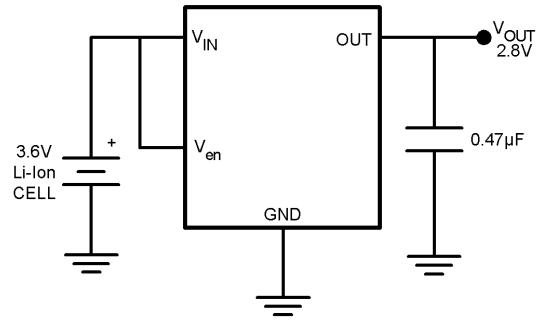
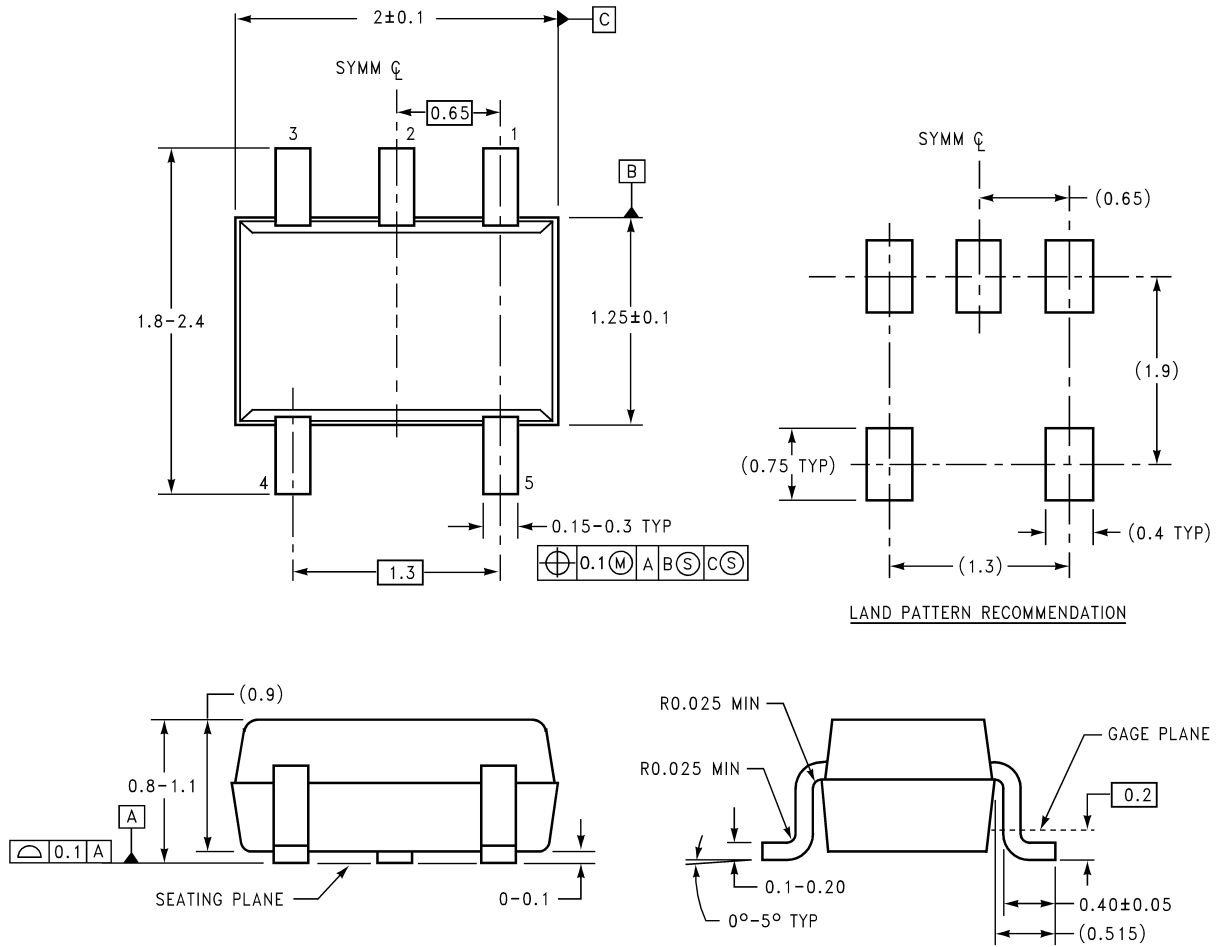

FIGURE 2. Single-Cell Regulator

Physical Dimensions inches (millimeters)

unless otherwise noted



DIMENSIONS ARE IN MILLIMETERS

MAA05A (REV B)

5-Pin SC70-5
NSC Package Number MAA05A

LIFE SUPPORT POLICY

NATIONAL'S PRODUCTS ARE NOT AUTHORIZED FOR USE AS CRITICAL COMPONENTS IN LIFE SUPPORT DEVICES OR SYSTEMS WITHOUT THE EXPRESS WRITTEN APPROVAL OF THE PRESIDENT AND GENERAL COUNSEL OF NATIONAL SEMICONDUCTOR CORPORATION. As used herein:

1. Life support devices or systems are devices or systems which, (a) are intended for surgical implant into the body, or (b) support or sustain life, and whose failure to perform when properly used in accordance with instructions for use provided in the labeling, can be reasonably expected to result in a significant injury to the user.
2. A critical component is any component of a life support device or system whose failure to perform can be reasonably expected to cause the failure of the life support device or system, or to affect its safety or effectiveness.



National Semiconductor Corporation
Americas
Email: support@nsc.com

www.national.com

National Semiconductor Europe
Fax: +49 (0) 180-530 85 86
Email: europe.support@nsc.com
Deutsch Tel: +49 (0) 69 9508 6208
English Tel: +44 (0) 870 24 0 2171
Français Tel: +33 (0) 1 41 91 8790

National Semiconductor Asia Pacific Customer Response Group
Tel: 65-2544466
Fax: 65-2504466
Email: ap.support@nsc.com

National Semiconductor Japan Ltd.
Tel: 81-3-5639-7560
Fax: 81-3-5639-7507